

Design Guide for the clock circuit with a crystal and Ricoh RTC IC

Each Ricoh RTC in Table 1 shown below has an oscillator circuit described in Fig.1. The oscillator circuit works only with the attachment of a 32768Hz crystal. Definitely RTC works, but depending on the parasitic capacitance of PCB etc., accuracy of the clock is not always good. For a better accuracy of the clock, some adjustment is necessary. PCB layout around the oscillator circuit sometimes causes a trouble without care, because the current level for this circuit is extremely small. This document explains how to design the oscillator circuit with a crystal and Ricoh RTC IC.

Fig. 1 Basic Example

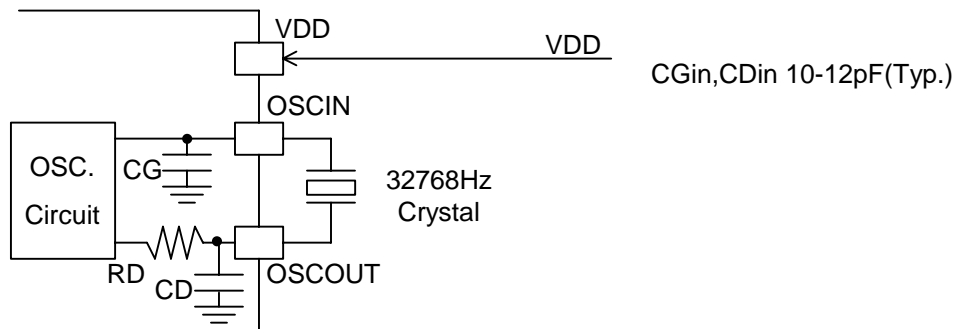

< Ricoh RTC lineup that is applied to this document >

This document is applied to the following Ricoh RTC lineup:

Table 1: The RTC applied to this document

	SSOP8	SSOP10	SSOP10G	TSSOP10G	FFP12	SSOP16
SPI (4 wire)	-	RS5C348A RS5C348B	RV5C348A RV5C348B	RT5C348B R2043T	R2043K	
3 wire	-	RS5C338A	RV5C338A RV5C339A	R2033T	R2061Kxx R2062Kxx R2033K	R2061Sxx
I ² C Bus	RS5C372A RS5C372B	-	RV5C386A RV5C387A	R2023T R2051T01	R2051Kxx R2023K	R2051Sxx

1. Characteristics of Oscillator circuit

1.1. CL value of a crystal

The load capacitance (CL) of the crystal is a critical parameter. The CL is not the capacitance of the crystal itself. CL means an external capacitance in parallel with the crystal.

Each crystal manufacturer offers several different CL value crystals with the same frequency.

When a crystal is connected to an oscillator circuit, if the specified CL value and external capacitance value in parallel with the crystal are the same, the frequency will be the specified value at normal temperature (25°C).

For example, in the Fig2,

When $CS+CG \times CD / (CG+CD) = CL$, the crystal oscillates at its nominal frequency (32768Hz).

When $CS+CG \times CD / (CG+CD) > CL$, the crystal oscillates slower than 32768Hz.

Further, when $CS+CG \times CD / (CG+CD) < CL$, the crystal oscillates faster than 32768Hz.

Fig. 2

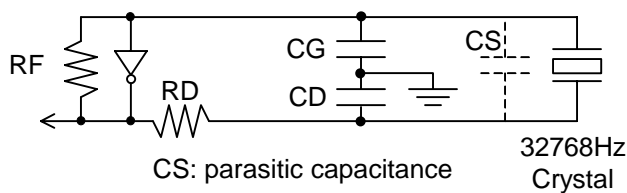

We recommend crystals with CL ranging from 6 to 8pF for our RTC IC. (CL range is from 6 to 9pF in terms of R2023x, R2033x, R2043x.)

Some crystal manufacturers offer a crystal with CL=12.5pF as a standard item.

If you choose a crystal with CL=12.5pF, refer to our "Oscillation frequency calibration with CL=12.5pF crystal and Ricoh RTC IC" (http://www.ricoh.com/LSI/product_rtc/info/125pf-e.pdf).

1.2. Oscillation allowance

To judge the oscillator circuit, oscillation allowance is a critical parameter. The oscillation allowance means the value of which the negative resistance (-r) of the oscillator frequency is divided by maximum equivalent series resistance of the crystal. Supposed that a resistor is added to a crystal in series as in Fig.3 shown below, then increase the resistance value until oscillator stops. The resistance value just before stopping the oscillation plus equivalent series resistance is approximately equal to negative resistance value. Considering the effect of the distribution among products and ambient temperature, choose the appropriate value crystal and the IC. Generally, 5 times is said to be an ideal value. Oscillation allowance is closely related to the value of CG, CD, and CS.

Each Ricoh RTC IC has an oscillation booster circuit to reduce the starting time for RTC. If the oscillation booster detects the oscillation halt, the booster boosts the driver of the oscillator in a certain term. Because of this, if the oscillator condition is bad, oscillation stops->oscillator booster starts->oscillator booster stops -> oscillation stops, the cycle will be intermittently repeated. If this phenomenon happens, the clock will be delay. Therefore, to evaluate the negative resistance value and oscillation allowance, it is necessary to judge the oscillation halting point is when the intermittent oscillation starts.

Fig.3

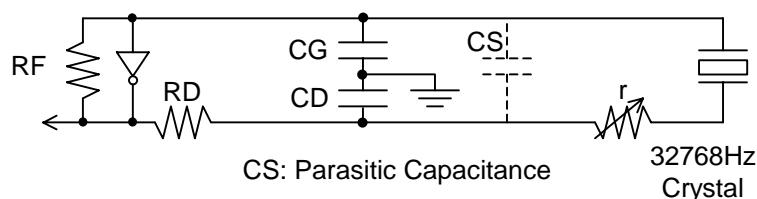

1.3. Correlation between the oscillation stabilize capacitors (CG, CD) and other characteristics

To compose the oscillator circuit, check the following items:

- Oscillator Frequency
- Oscillation Maintained Voltage
- Consumption Current
- Oscillation Allowance
- Start-up time for oscillation

Graphs which describes the frequency, oscillation maintained voltage, consumption current, oscillation allowance with R2051K01 and a external CGOUT, are shown below:

Oscillator frequency deviation vs. CGOUT
 Ta=25°C, with FC135(Seiko Epson)
 CGOUT=0pF's deviation=0ppm

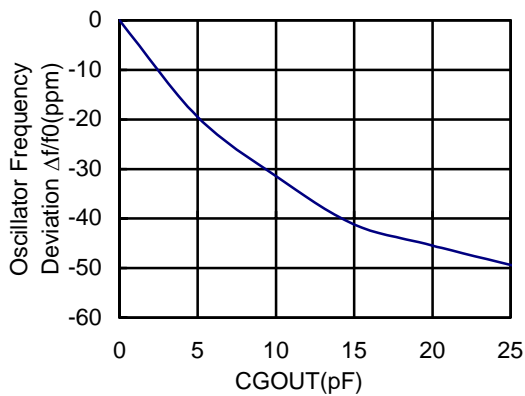

Consumption current of operating as clock vs. CGOUT
 Ta=25°C, with FC135(Seiko Epson)

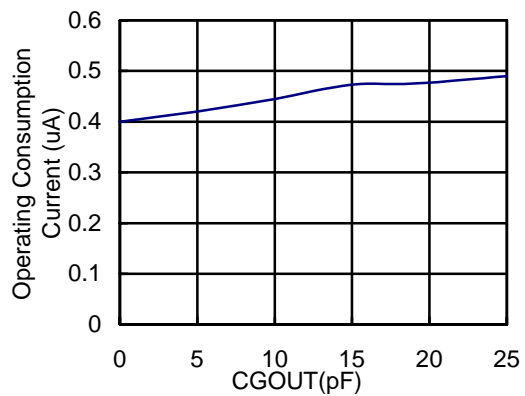

Oscillation maintained voltage vs. CGOUT
 Ta=25°C, with FC135(Seiko Epson)

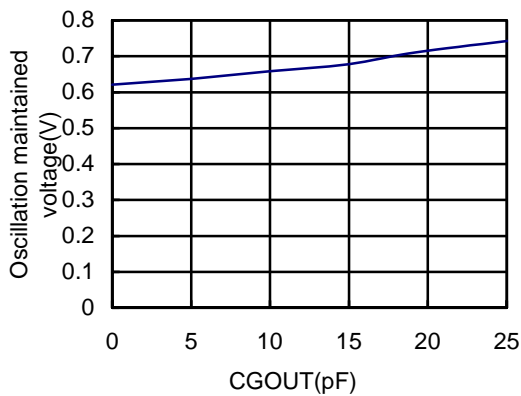

Oscillation allowance vs. CGOUT
 Ta=25°C, with FC135(Seiko Epson)

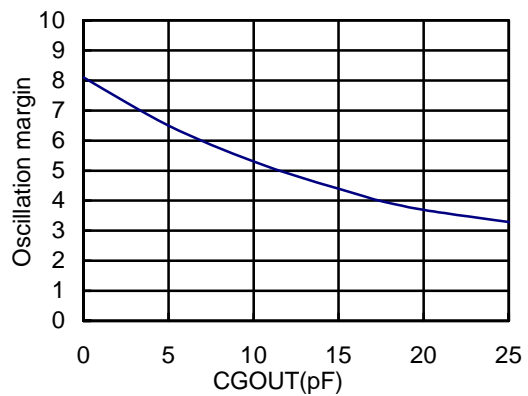

General tendency of CG and CD vs. characteristics is shown in the next table.

Table 2.

Small Value<-	(CG, CD)	->Large value
High	Oscillator Frequency	Low
Low	Oscillation maintained voltage	High
Small	Consumption Current	Large
Large	Oscillation Allowance	Small
Short	Oscillation start-up time	Long

As described in the table shown above, the smaller value of CG and CD, the better the most

characteristics except oscillator frequency are.

As it was mentioned in the chapter 1.3 of this document, if you choose a crystal with small CL, you can make CG and CD small. In other words, if you choose a crystal with small CL, most characteristics shown above will be improved.

1.4. Effect by the third capacitance (CS)

In this section, the effect by the parasitic capacitance of PCB, so-called CS, is described. Next graphs are the typical characteristics of oscillator frequency and oscillator frequency deviation vs. CS.

Sample: RV5C338A

CS value: Instead of actual capacitance, external capacity is used for this experiment.

Oscillator frequency deviation vs. CS
 Ta=25°C, with CFS145(Citizen)
 Deviation=0ppm, specified at CGOUT=0pF

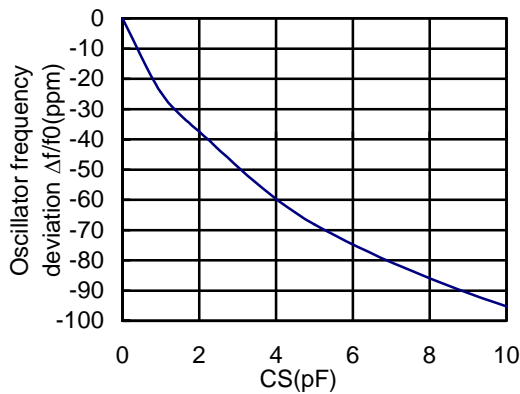

Oscillation start-up time vs. CS
 Ta=25°C, with CFS145(Citizen)

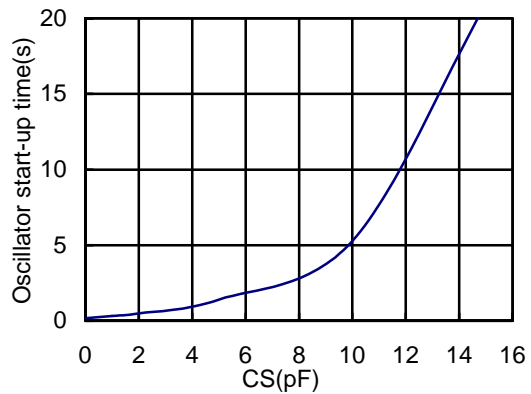

As the graphs shown above, oscillator frequency and start-up time varies depending on CS value.

Therefore, make the wiring as short as possible to reduce the parasitic capacity of PCB, especially, board layout which the capacity is generated between OSCIN and OSCOUT, should be avoided.

1.5. Measurement of Oscillator Frequency

To check the frequency, there are some tips to measure the correct frequency. If you use probes for OSCIN and OSCOUT directly, frequency will vary because of the capacitance of probes. Generally, probes have approximately 15pF capacitance. As the graph shown in "Oscillator frequency deviation vs. CGOUT" in page 3, when the capacitance for CGOUT is 15pF, frequency varies approximately 40ppm. To avoid this, our option is useful.

Most of Ricoh RTC has 32k clock output pin. From this pin, the IC outputs the clock with same frequency as the oscillator circuit, and if some capacities are added, the frequency is maintained.

When you check the frequency, we recommend using this 32k output pin.

In terms of R2061K01, there is no 32k output pin. However, the interrupt pin can output 1Hz clock with a specific setting. If clock adjustment register is not set, the frequency of the circuit is 32768 times of the measured 1Hz clock.

1.6. Oscillator Frequency Dispersion data caused by ICs

Supposed that the crystal has no dispersion, if the IC is replaced to other IC, capacity of the IC itself is different, so frequency may change. For your reference, dispersion of the oscillator frequency deviation by IC graph is shown below:

RV5C338A oscillator frequency dispersion

Samples: 98lots, 5pieces from each lot are measured.

Crystal: MS2V-TS, CL=7pF(Micro Crystal)

Ta=23°C, VDD=3V, with a socket. 0ppm considered as average, and redistributed.

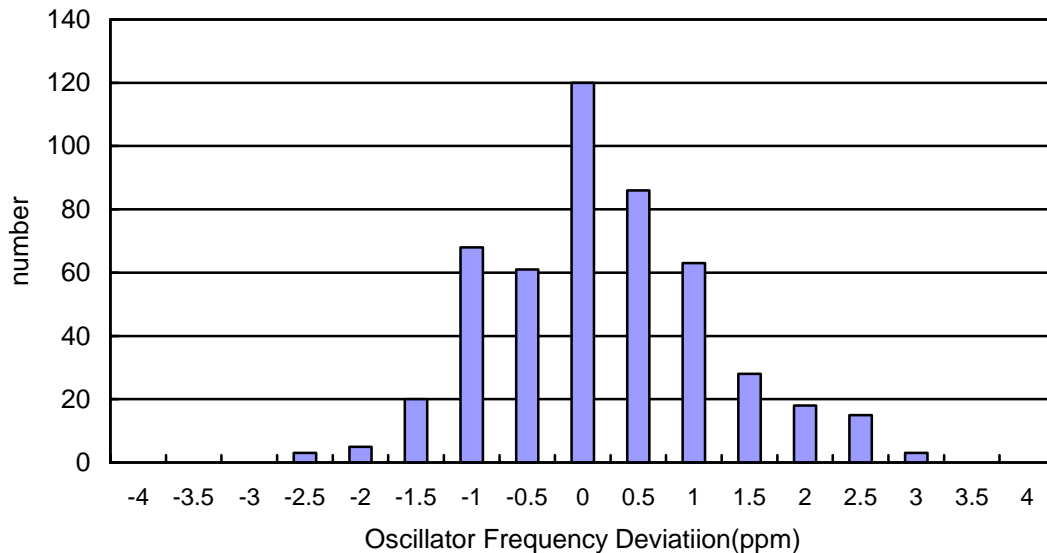

In the graph above, for example the position of horizontal "0ppm", vertical number means the number of samples ranging from -0.5 to 0.0ppm frequency deviation. Standard deviation of the graph is 0.99ppm.

1.7. Oscillator frequency and monthly error

Generally, the unit shown the oscillator frequency deviation is ppm. On the other hand, the error of the clock is described as monthly error.

For example, $\pm 10\text{ppm}$ error is equal to $\pm 10 \times 10^{-6} \times 60 \times 60 \times 24 \times 30 = \pm 25.9\text{s/month}$. $\pm 23\text{ppm}$ error is almost equal to one minute per month error.

2. Notes on PCB layout

This section describes the technical notes on PCB layout.

- (1) Pins of the crystal and OSCIN/OSCOUT pins of real time clock should be as close as possible to reduce the parasitic capacitance.
- (2) Avoid the long parallel pattern or cross pattern of OSCIN and OSCOUT.
- (3) OSCIN/OSCOUT lines and other lines should be as far as possible and they should not be crossed.

Oscillator frequency circuit's current capacity is limited to reduce the consumption current. Therefore, they are sensitive against the noise.

- (4) If possible, we recommend a guard ring with GND line around oscillator circuit, and the layer right under this pattern, put the GND plane to make a light shield against noise. To set the real time clock IC and crystal far from other lines' noise, putting them at the side of the PCB is another good idea.

Fig.4

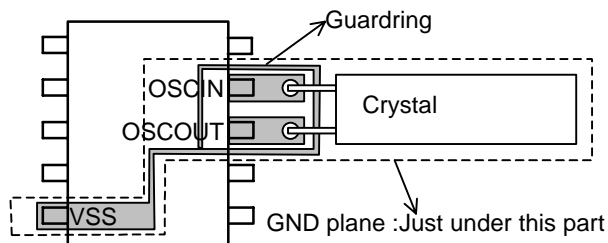

In terms of R2051Sxx and R2061Sxx, to make the layout as above easy, OSCIN/OSCOUT pins are between NC pins, which can be connected to the GND.

Fig.5

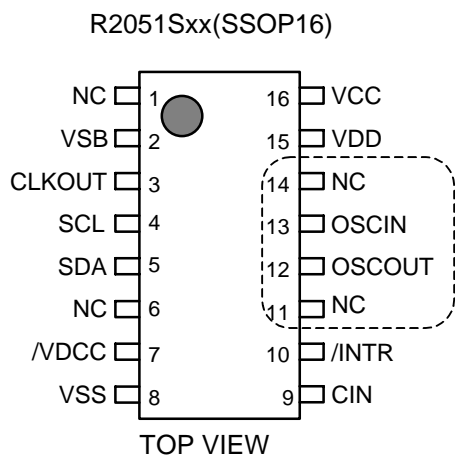

3. Adjustment of gain and loss of the clock

3.1. Conventional adjustment method of oscillator frequency

CG and CD are built-in the most of Ricoh real time clock ICs. However, depending on the capacitance of the PCB, and characteristics of the crystal, adjustment might be necessary.

As a conventional method, adjustment is possible as in the Fig. 6.

If the larger CGOUT/CDOUT is set, frequency will be low. On the contrary, if the smaller capacitors are set, frequency will be high.

Note that large capacitance may cause increase of the time keeping current and oscillation maintained voltage, and decrease the oscillation allowance, and change the oscillation start-up time.

Fig.6

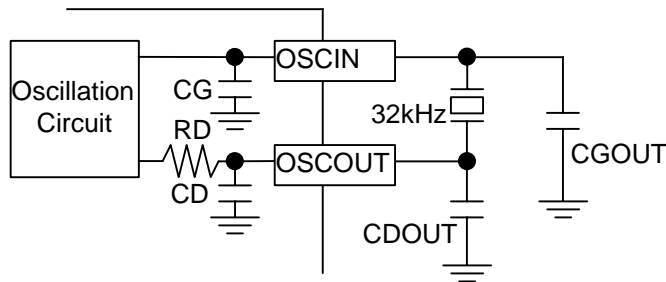

3.2. Adjustment with Software calibration

Without additional CGOUT/CDOUT, adjustment of gain and loss of the clock is possible.

The oscillator calibration circuit is configured to change time counts of 1 second on the basis of the settings of the oscillation calibration register once in 20seconds or once in one minute.

The advantage of this method is that the time keeping current, oscillation maintained voltage, oscillation allowance, oscillation start-up time can be kept its original characteristics because it is not necessary to change the oscillator circuit itself.

If the clock gains, write the calculated value for adjustment to the clock adjustment register of the clock.

Adjustment value = (Measured frequency - Target frequency) × 10 + 1

Excel software file for executing this calculation is on our Web site.

http://www.ricoh.com/LSI/product_rtc/

If following 3 conditions are completed, actual clock adjustment value could be different from target adjustment value that set by oscillator adjustment function.

1. Using oscillator adjustment function
2. Access to RTC at random, or synchronized with external clock that has no relation to RTC, or synchronized with periodic interrupt in pulse mode.
3. Access to RTC more than 2 times per each second on average.

For more details, please contact to Ricoh.

3.3. Evaluation and Confirmation method for software calibration of the clock

The clock adjustment circuit is configured to change time counts of 1 second on the basis of the settings of the clock adjustment register once in 20seconds. The clock adjustment pulse output from the 32KOUT pin. Therefore, after writing the clock adjustment register, we cannot measure the clock error with probing 32KOUT clock pulses. The way to measure the clock error as follows:

- (1) Output a 1Hz clock pulse of Pulse Mode with interrupt pin
 Each RTC has different 1Hz output pin and the way to set the register.
 Refer to the Table 3.

Table 3: 1Hz output pin and the way to set the register for output 1Hz clock

	Setting	Output Pin
RS5C372A	Address Eh ← (00000011)	/INTRA(5pin)
RS5C372B		/INTR(5pin)
RS/RV5C338A	Address Eh ← (00XX0011)	/INTR(6pin)
RV5C339A		/INTRA(6pin)
RS/RV/RT5C348A/B, R2043T		/INTR(6pin)
RV5C386A/387A,R2023T		/INTRA(6pin)
R2043K,R2033K		/INTR(10pin)
R2023K		/INTRA(10pin)
R2051Kxx,R2061Kxx, R2062Kxx		/INTR(9pin)
R2051Sxx,R2061Sxx		/INTR(10pin)

- (2) After setting the clock calibration register, 1Hz clock period changes every 20seconds as in Fig. 7.

Fig.7

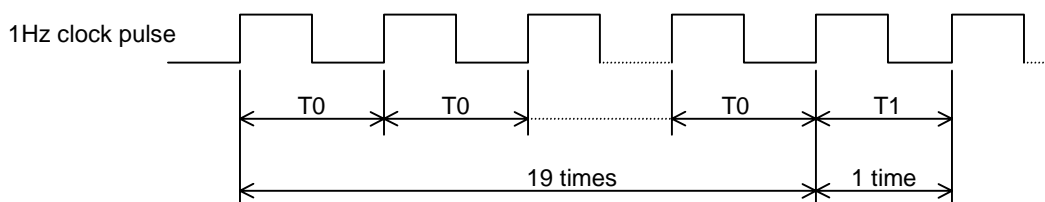

Measure the interval of T0 and T1 with frequency counter. A frequency counter with 7 or more digits is recommended for the measurement.

- (3) Calculate the typical period from T0 and T1

$$T = (19 \times T0 + 1 \times T1) / 20$$

Calculate the time error from T.

This method can be used under development stage, for mass production, this method is time-consuming. The circuit for oscillator calibration of the clock is digital base, therefore, with 32k clock frequency and calculated value, exact gain and loss of the clock can be foreseen.

3.4. Notes on using the oscillator calibration circuit

When using the oscillator calibration circuit,

- (1) Ricoh's RTC does not have non-volatile memory. Therefore, the system must store the oscillator adjustment value to non-volatile memory external of the RTC. The system must write the oscillation adjustment value to RTC, when setting the clock and calendar data.
 (2) Oscillation Adjustment Circuit does not affect the frequency of 32768Hz-clock pulse output from the 32KOUT pin. If the frequency of clock pulse from 32KOUT pin should be accurate, use the conventional adjustment method, or change the CL value of the crystal.

3.5. Appropriate target frequency

The temperature characteristic of discrete 32768Hz crystal is described as following formula:

$$\Delta f/f_0 = \alpha(T - \theta T)^2 + (f_0 - f_s)/f_0$$

Peak temperature: $\theta T = 25 \pm 5^\circ\text{C}$

Temperature coefficient: $\alpha = (-0.035 \pm 0.005) \times 10^{-6}/^\circ\text{C}^2$

Nominal Frequency: $f_s = 32768\text{Hz}$

Frequency at peak temperature: f_0

For adjustment of gain and loss of the clock, with the conventional method, f_0 is adjusted with external capacitors. In the case of adjustment with the oscillator calibration circuit, f_0 is substantially adjusted in different way.

Considering the whole oscillator circuit, the real time clock IC has also temperature coefficient, but it is much smaller than equivalent of crystal. Therefore, the temperature characteristics of the IC can be ignored.

Typical temperature characteristic of the crystal is as follows:

Frequency of the crystal vs. temperature (Typ.)

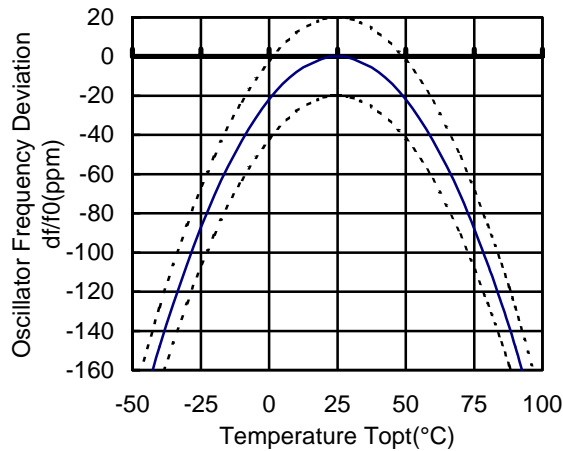

As the graph shown above, frequency temperature characteristic of the crystal is the parabola of which the peak is at 25°C.

Supposed that target frequency, $f_0=32768\text{Hz}$, then, if the temperature rises, or falls, the clock will lose.

Therefore, normally, to gain for the clock at 25°C, adjustment is done. The level of gain depends on the place and the environment where the application will be used.

In the next table, appropriate f_0 value list for the area. Data source is the Meteorological Agency.

Appropriate f_0 list from annual average temperature data by area

	f_0	Oscillator Frequency Deviation $(f_0-f_s)/f_0$
Sapporo	32768.42Hz	12.7ppm
Tokyo	32768.16Hz	4.7ppm
Nagano	32768.28Hz	8.6ppm
Naha	32768.03Hz	0.9ppm

Calculation is done, based on the hourly temperature data by the Meteorological Agency in 2000.

Temperature is measured in the ventilated case for meteorological instruments in 1.5m altitude. If the application is used at the room temperature, the temperature variation is more moderate than actual outside temperature, therefore, f_0 is not so large.

Generally, f_0 's ranging from 32768.1Hz to 32768.2Hz, or frequency deviation is adjusted from 3 to 6ppm.

4. Trouble Shooting

4.1. Clock gains

(1) Case: The clock gains 5 to 9 seconds a day. (60 to 100ppm gain)

Estimated cause) Ricoh RTC recommends a crystal with CL=6 to 8pF. On the other hand, some crystal manufacturers designate crystals with CL=12.5pF are standard items. If such crystals are used with Ricoh RTC, built-in capacitance of the IC and CL value matching will be bad, therefore the clock gains 60 to 100ppm.

Countermeasure) Change the crystal to the appropriate one with CL=6 to 8 pF or adjust it with referring to chapter 3.2 of this document. If you choose the crystal with CL=12.5pF (or CL=9pF except R2023x, R2033x, R2043x), another reference is "Oscillation frequency calibration with CL=12.5pF crystal and Ricoh RTC IC" (http://www.ricoh.com/LSI/product_rtc/info/125pf-e.pdf).

(2) Case: The clock gains about 35 minutes a day. (with RS5C372A/B)

Estimated cause) RS5C372A/B can use both crystals of 32768Hz and 32000Hz. If the RTC is used with 32768Hz crystal at 32000Hz mode, the clock gains 35 minutes per day.

Countermeasure) Write "0" to D7, /XSL bit of the address 7h and use the 32768Hz mode. When the time is set, write "0" to this bit is recommended procedure.

4.2. Clock loses/ stops

(1) Case: The clock loses 34 minutes per hour. (RS/V5C338A, RV5C339A, RS/V5C348A/B)

Estimated cause) The RS/V5C338A, RV5C339A, and the RS/V5C348A/B have the unique mode. If "1" is written to (0), D7 of the address 7h, clock loses 56% of the normal mode.

Countermeasure) Write "0" to (0), D7 of the address 7h, use with the normal mode. When the time is set, write "0" to this bit is recommended procedure.

(2) Case: The oscillation is intermittent and the clock loses.

Estimated cause) Oscillation booster circuit is built in Ricoh RTC ICs to shorten the oscillation start-up time. The oscillation booster drives the oscillator inverter for a certain time if the RTC detects the halt of the oscillator. If the oscillation conditions are bad, operation cycle will be that the oscillation stops, the booster starts, the oscillation booster stops, then oscillation stops. The operation becomes intermittent, and if the intermittent oscillation occurs, the clock will lose.

Countermeasure) Use smaller capacitance as CGOUT and CDOUT than present value. If the clock gains, refer to the chapter 4.1 of this document and adjust it.

(3) Case: Oscillation stops because of the temperature change. (The clock stops.)

Estimated cause) Because of condensation, leakage between oscillator pins and other pin is generated and oscillation stops.

Countermeasure) Coating pins of the oscillator circuit and oscillator pins of the IC with the materials which have high electric conductivity is necessary.

As for the oscillator circuits of R2051/61/62, R2043, R2023, R2033 or after these part numbers, the circuit against the condensation exists, therefore leakage between power supply, Vss pin, OSCIN, and OSCOUT is much less than before.

RICOH