

150mA Dual LDO REGULATOR

NO.EA-127-130501

OUTLINE

The R5325x Series are CMOS-based voltage regulator ICs with high output voltage accuracy, low supply current (Typ. 3.0 μ A), low dropout, and fast transient response. Each of these voltage regulator ICs consists of a voltage reference unit, an error amplifier, resistors for setting output voltage, a current limit circuit, and a chip enable circuit.

These ICs perform with low dropout voltage due to built-in transistor with low ON resistance, and a chip enable function prolongs the battery life of each system. The line transient response and load transient response of the R5325x Series are excellent, thus these ICs are very suitable for the power supply for hand-held communication equipment.

The supply current at no load of R5325x Series is remarkably reduced compared with R5323x Series. The mode change signal to reduce the supply current is not necessary.

The output voltage of these ICs is internally fixed with high accuracy ($\pm 1.0\%$). Since the packages for these ICs are SOT-23-6 and DFN(PLP)1820-6 package, dual LDO regulators are included in each, high density mounting of the ICs on boards is possible.

FEATURES

- Supply Current Typ. 3.0 μ A (VR1, VR2)
- Standby Current Typ. 0.1 μ A (VR1, VR2)
- Dropout Voltage Typ. 0.2V ($I_{OUT}=150\text{mA}$, $V_{OUT}=3.0\text{V}$)
- Ripple Rejection Typ. 55dB ($f=1\text{kHz}$)
- Input Voltage 1.5V to 6.0V
- Output Voltage Range..... 1.2V to 4.0V (0.1V steps)
(For details, please refer to MARK INFORMATION.)
- Output Voltage Accuracy..... $\pm 1.0\%$
- Temperature-Drift Coefficient of Output Voltage Typ. $\pm 100\text{ppm}/^\circ\text{C}$
- Line Regulation Typ. 0.1%/V
- Packages DFN(PLP)1820-6, SOT-23-6
- Built-in fold-back protection circuit Typ. 50mA (Current at short mode)
- Ceramic Capacitor is recommended. 0.1 μ F or more
- Built-in chip enable circuit (active "H")
- Fast Transient Response Time from large load current to small load current. (50% less than R5323x)

APPLICATIONS

- Power source for handheld communication equipment.
- Power source for electrical appliances such as cameras, VCRs and camcorders.
- Power source for battery-powered equipment.

BLOCK DIAGRAMS

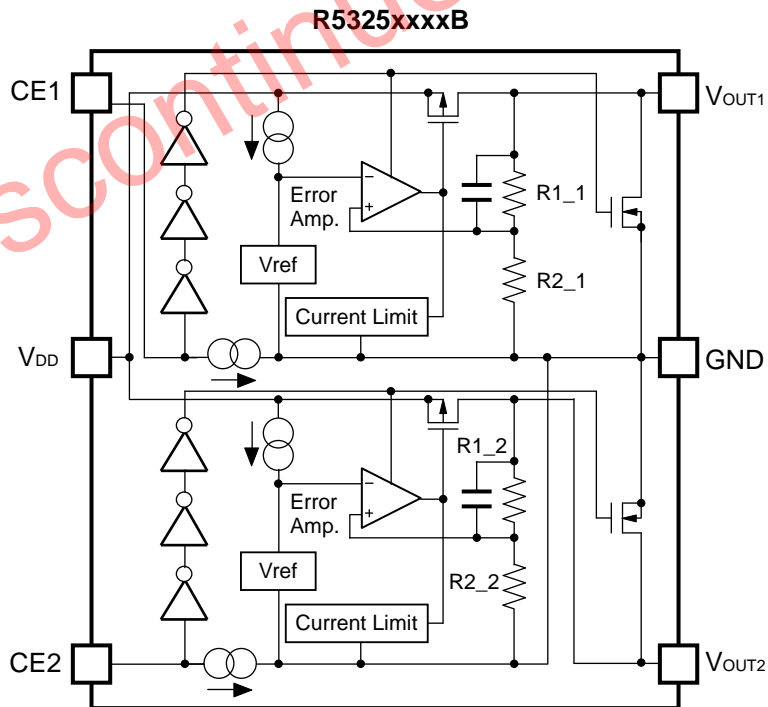
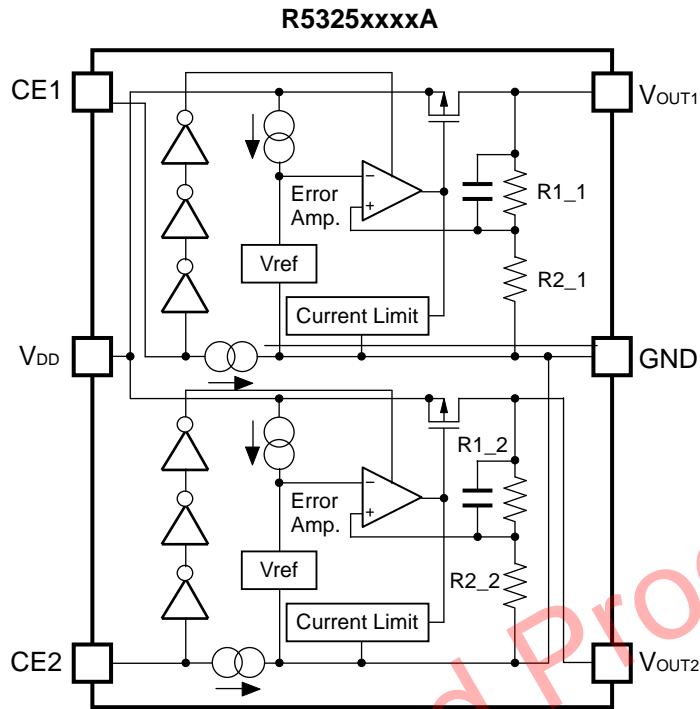

SELECTION GUIDE

The output voltage, auto discharge function, package, etc. for the ICs can be selected at the user's request.

Product Name	Package	Quantity per Reel	Pb Free	Halogen Free
R5325Kxxx*-TR	DFN(PLP)1820-6	3,000 pcs	Yes	Yes
R5325Nxxx*-TR-FE	SOT-23-6	3,000 pcs	Yes	Yes
<p>xxx : The combination of output voltage for each channel can be designated by serial numbers. (from 001) The output voltage for each channel can be set in the range from 1.2V to 4.0V in 0.1V steps. (For details, please refer to MARK INFORMATIONS.)</p> <p>* : The auto discharge function at off state are options as follows. (A) without auto discharge function at off state (B) with auto discharge function at off state</p>				

Discontinued Product

PIN CONFIGURATION

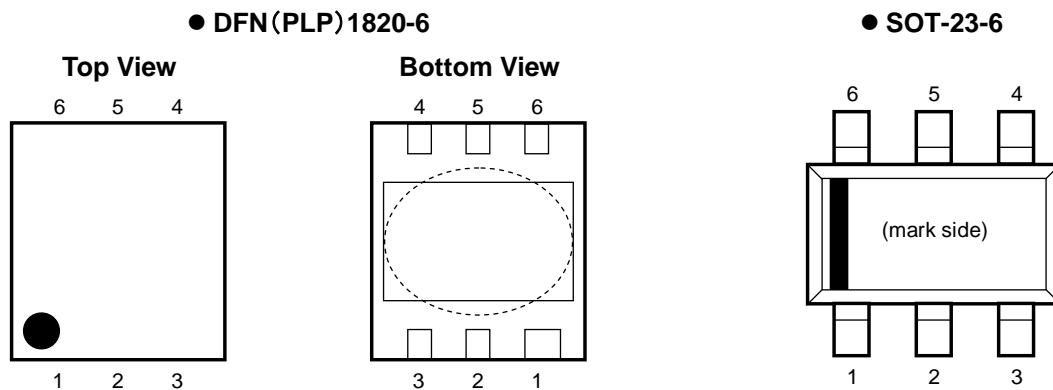

PIN DESCRIPTIONS

● DFN(PLP)1820-6

Pin No	Symbol	Pin Description
1	V_{OUT2}	Output Pin 2
2	V_{DD}	Input Pin
3	V_{OUT1}	Output Pin 1
4	CE1	Chip Enable Pin 1 ("H" Active)
5	GND	Ground Pin
6	CE2	Chip Enable Pin 2 ("H" Active)

*) Tab is GND level. (They are connected to the reverse side of this IC.)

The tab is better to be connected to the GND, but leaving it open is also acceptable.

● SOT-23-6

Pin No	Symbol	Pin Description
1	V_{OUT1}	Output Pin 1
2	V_{DD}	Input Pin
3	V_{OUT2}	Output Pin 2
4	CE2	Chip Enable Pin 2 ("H" Active)
5	GND	Ground Pin
6	CE1	Chip Enable Pin 1 ("H" Active)

ABSOLUTE MAXIMUM RATINGS

Symbol	Item	Rating	Unit
V_{IN}	Input Voltage	6.5	V
V_{CE}	Input Voltage (CE Pin)	-0.3 to 6.5	V
V_{OUT}	Output Voltage	-0.3 to $V_{IN} + 0.3$	V
I_{OUT1}, I_{OUT2}	Output Current	200	mA
P_D	Power Dissipation (DFN(PLP)1820-6) *	880	mW
	Power Dissipation (SOT-23-6) *	420	
T_{opt}	Operating Temperature Range	-40 to 85	°C
T_{stg}	Storage Temperature Range	-55 to 125	°C

*) For Power Dissipation, please refer to PACKAGE INFORMATION.

ABSOLUTE MAXIMUM RATINGS

Electronic and mechanical stress momentarily exceeded absolute maximum ratings may cause the permanent damages and may degrade the life time and safety for both device and system using the device in the field.

The functional operation at or over these absolute maximum ratings is not assured.

RECOMMENDED OPERATING CONDITIONS (ELECTRICAL CHARACTERISTICS)

All of electronic equipment should be designed that the mounted semiconductor devices operate within the recommended operating conditions. The semiconductor devices cannot operate normally over the recommended operating conditions, even if when they are used over such conditions by momentary electronic noise or surge. And the semiconductor devices may receive serious damage when they continue to operate over the recommended operating conditions.

ELECTRICAL CHARACTERISTICS

• R5325xxxxA/B

T_{opt}=25°C

Symbol	Item	Conditions	Min.	Typ.	Max.	Unit	
V _{OUT}	Output voltage	V _{IN} =Set V _{OUT} +1V I _{OUT} =1mA	V _{OUT} ≥ 1.5V	×0.99	×1.01	V	
			V _{OUT} < 1.5V	-15mV	+15mV		
I _{OUT}	Output Current	V _{IN} -V _{OUT} =1.0V	150			mA	
ΔV _{OUT} /ΔI _{OUT}	Load regulation	V _{IN} =Set V _{OUT} +1V 1mA ≤ I _{OUT} ≤ 150mA		30	80	mV	
V _{DIF}	Dropout Voltage	I _{OUT} =150mA	1.2V ≤ V _{OUT} < 1.3V		0.55	0.85	V
			1.3V ≤ V _{OUT} < 1.4V		0.48	0.74	
			1.4V ≤ V _{OUT} < 1.5V		0.43	0.68	
			1.5V ≤ V _{OUT} < 2.0V		0.40	0.59	
			2.0V ≤ V _{OUT} < 2.8V		0.27	0.39	
			2.8V ≤ V _{OUT} < 4.0V		0.21	0.28	
			V _{OUT} = 4.0V		0.17	0.23	
I _{SS}	Supply Current	V _{IN} =Set V _{OUT} +1V, I _{OUT} =0mA		3	7	μA	
I _{standby}	Standby Current	V _{IN} =6V V _{CE} =GND		0.1	1.0	μA	
ΔV _{OUT} /ΔV _{IN}	Line regulation	Set V _{OUT} +0.5V ≤ V _{IN} ≤ 6.0V I _{OUT} =30mA		0.1	0.3	%/V	
RR	Ripple Rejection	f=1kHz Ripple 0.5Vp-p V _{IN} -V _{OUT} =1.0V, I _{OUT} =30mA (In case that V _{OUT} ≤ 1.7V, V _{IN} =Set V _{OUT} +1.2V)		55		dB	
V _{IN}	Input Voltage		1.5		6.0	V	
ΔV _{OUT} /ΔT _{opt}	Output Voltage Temperature Coefficient	I _{OUT} =30mA -40°C ≤ T _{opt} ≤ 85°C		±100		ppm/°C	
I _{SC}	Short Current Limit	V _{OUT} =0V		50		mA	
I _{PD}	CE Pull-down Constant Current		0.15	0.30	0.55	μA	
V _{CEH}	CE Input Voltage "H"		1.0		6.0	V	
V _{CEL}	CE Input Voltage "L"		0		0.4	V	
e _n	Output Noise	BW=10Hz to 100kHz		30		μVrms	
R _{LOW}	Low Output Nch Tr. ON Resistance (of B version)	V _{CE} =0V		50		Ω	

TYPICAL APPLICATION

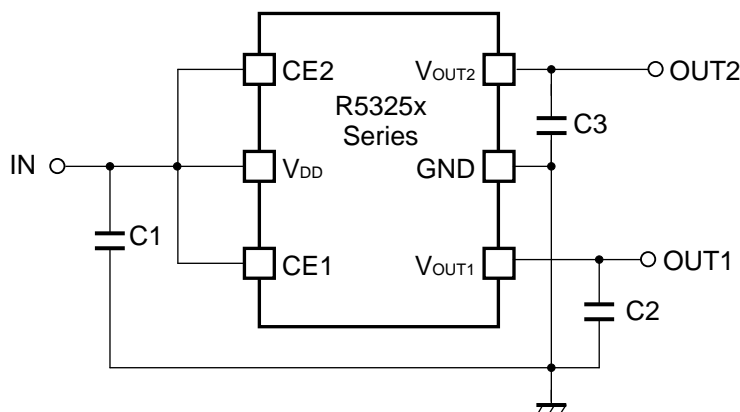

(External Components)

Output Capacitor; Ceramic Type

0.1 μ F	Kyocera	CM05B104K06AB
	Murata	GRM155B31C104KA87B
1.0 μ F	Kyocera	CM05X5R105K06AB
	TDK	C1005JB0J105K
	Murata	GRM155B30J105KE18B

1. Mounting on PCB

Make V_{DD} and GND lines sufficient. If their impedance is high, noise pickup or unstable operation may result. Connect a capacitor with a capacitance value as much as 0.1 μ F or more as C1 between V_{DD} and GND pin, and as close as possible to the pins.

Set external components, especially the output capacitor, as close as possible to the ICs, and make wiring as short as possible.

2. Phase Compensation

In these ICs, phase compensation is made for securing stable operation even if the load current is varied. For this purpose, use a capacitor C2 and C3 with good frequency characteristics and ESR (Equivalent Series Resistance).

(Note: If additional ceramic capacitors are connected with parallel to the output pin with an output capacitor for phase compensation, the operation might be unstable. Because of this, test these ICs with as same external components as ones to be used on the PCB.)

If you use a tantalum type capacitor and ESR value of the capacitor is large, output might be unstable. Evaluate your circuit with considering frequency characteristics.

Depending on the capacitor size, manufacturer, and part number, the bias characteristics and temperature characteristics are different. Evaluate the circuit with actual using capacitors.

TEST CIRCUIT

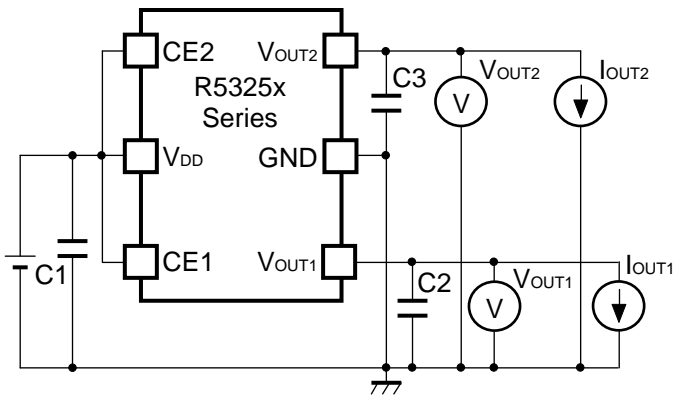

* C1=C2=C3=Ceramic 0.1 μ F

Fig.1 Standard test Circuit

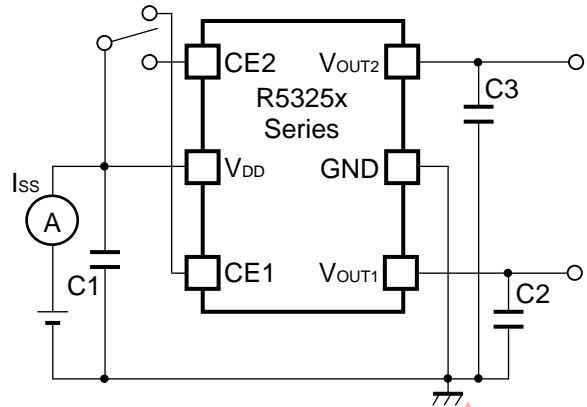

* C1=C2=C3=Ceramic 0.1 μ F

Fig.2 Supply Current Test Circuit

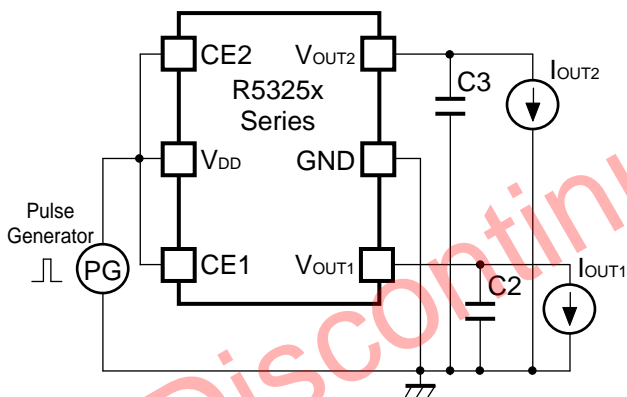

* C2=C3=Ceramic 0.1 μ F

Fig.3 Ripple Rejection, Line Transient Response Test Circuit

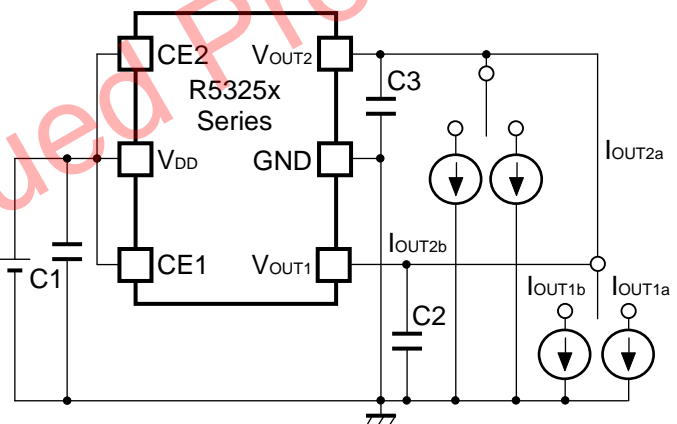

* C1=C2=C3=Ceramic 0.1 μ F

Fig.4 Load Transient Response Test Circuit

TYPICAL CHARACTERISTICS

1) Output Voltage vs. Output Current (T_{opt}=25°C)

1.2V (VR1/VR2)

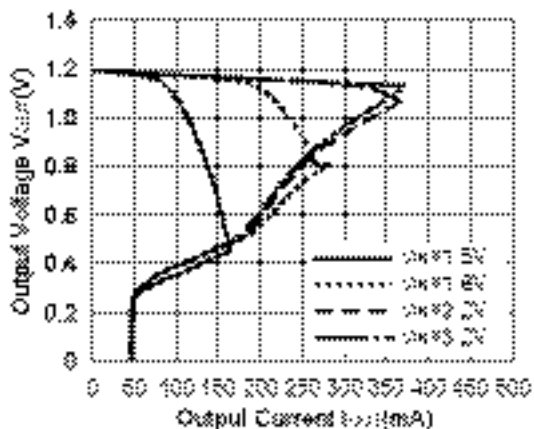

2.8V (VR1/VR2)

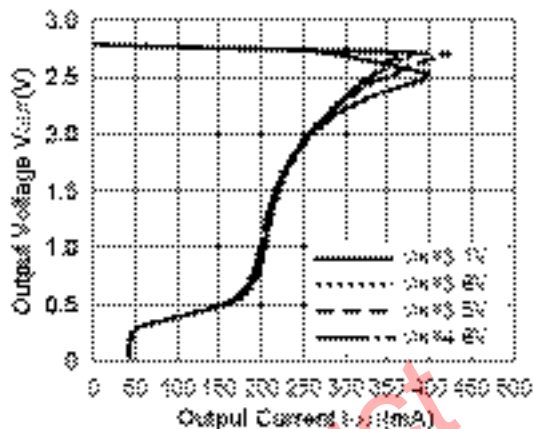

4.0V (VR1/VR2)

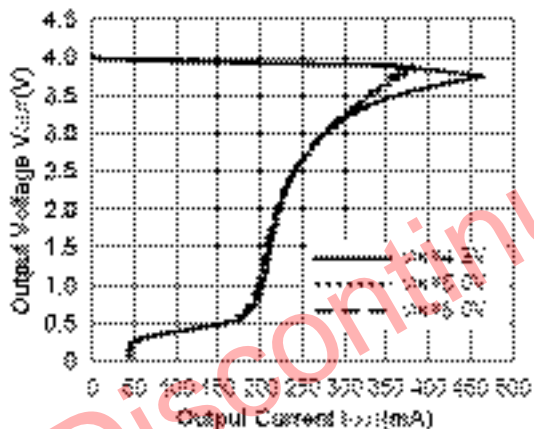

2) Output Voltage vs. Input Voltage (T_{opt}=25°C)

1.2V (VR1/VR2)

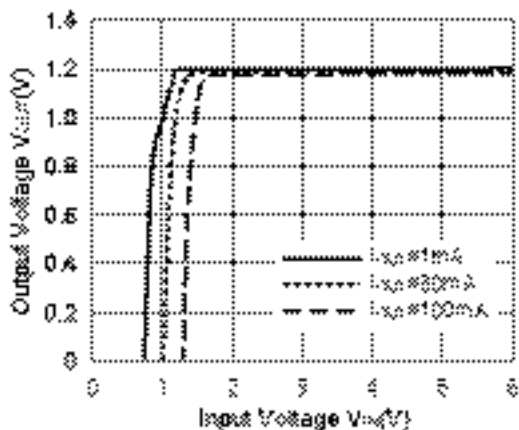

2.8V (VR1/VR2)

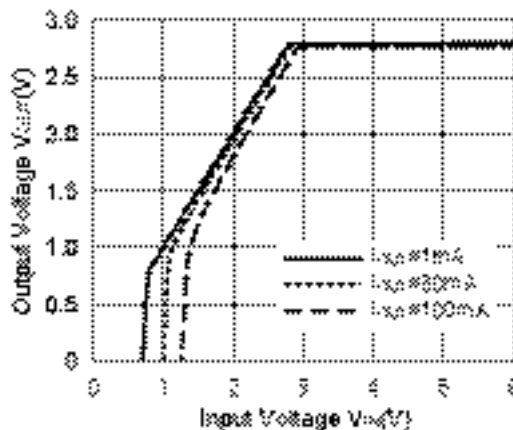

4.0V (VR1/VR2)

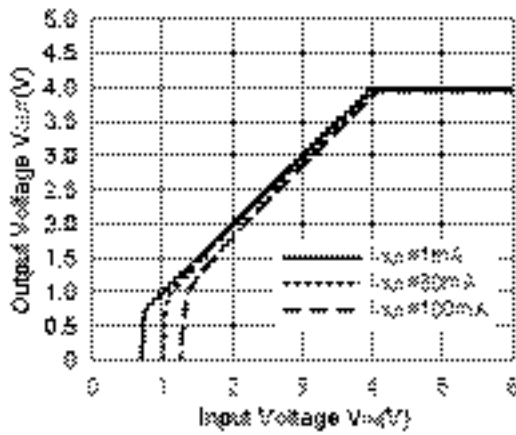

3) Dropout Voltage vs. Output Current

1.2V (VR1/VR2)

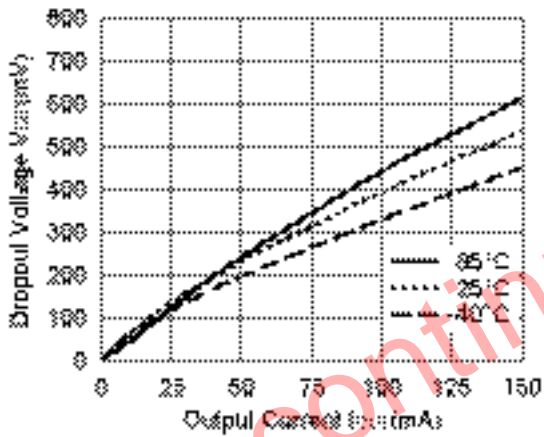

2.8V (VR1/VR2)

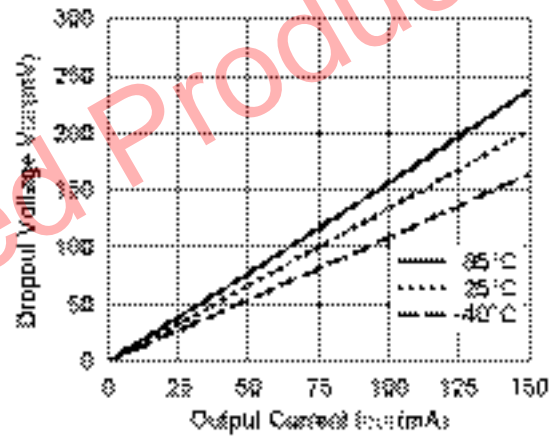

4.0V (VR1/VR2)

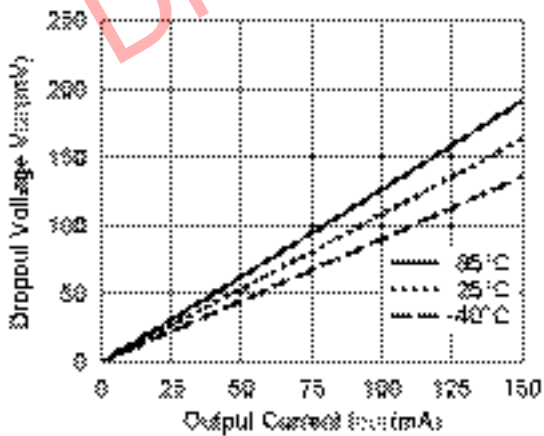

4) Output Voltage vs. Temperature ($I_{OUT}=30mA$)

1.2V (VR1/VR2)

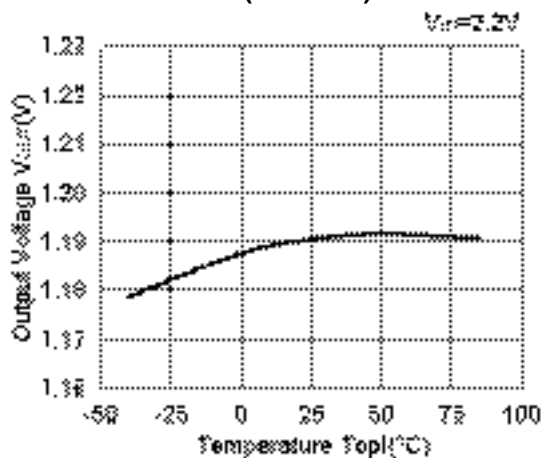

2.8V (VR1/VR2)

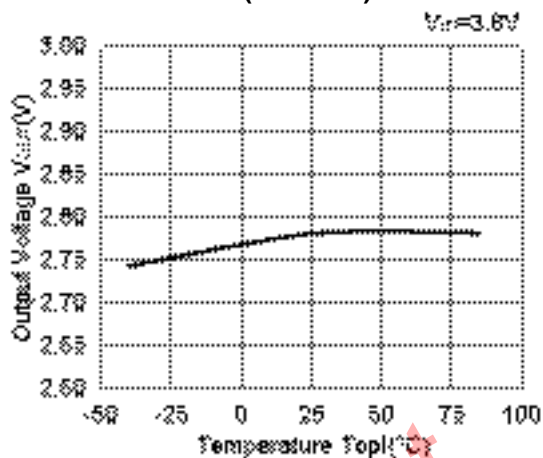

4.0V (VR1/VR2)

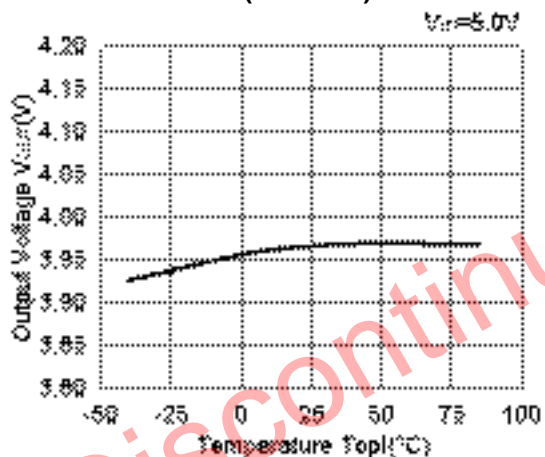

5) Supply Current vs. Input Voltage ($T_{opt}=25^{\circ}C$)

1.2V (VR1/VR2)

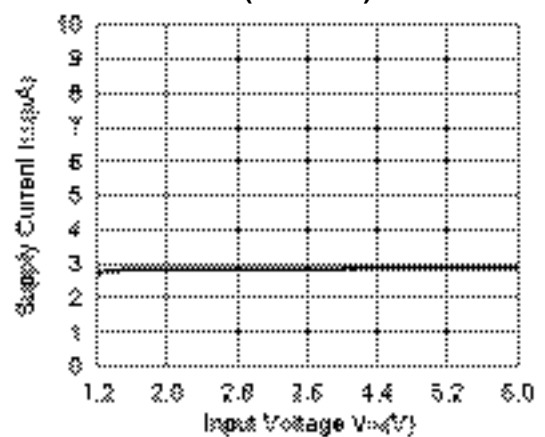

2.8V (VR1/VR2)

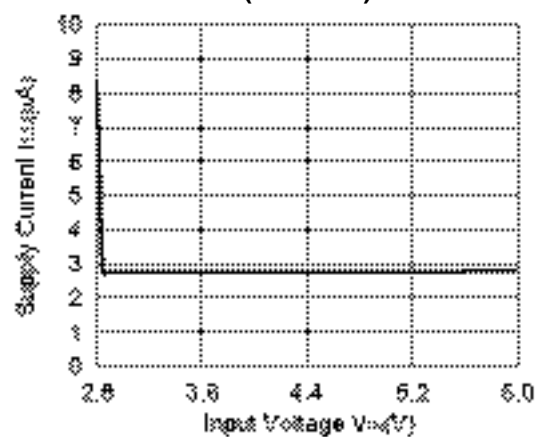

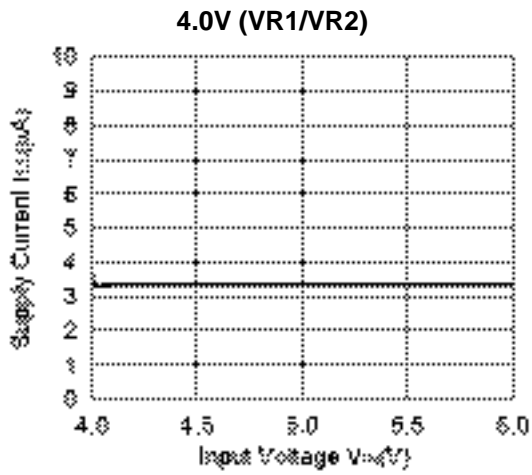

6) Supply Current vs. Temperature

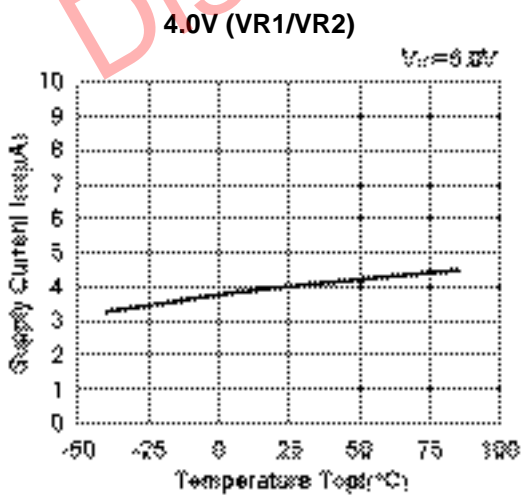
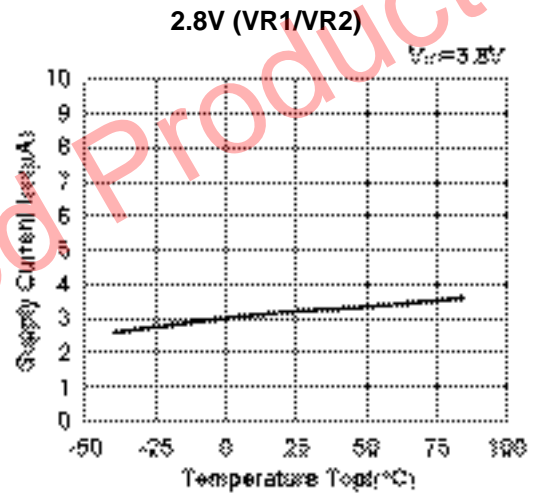
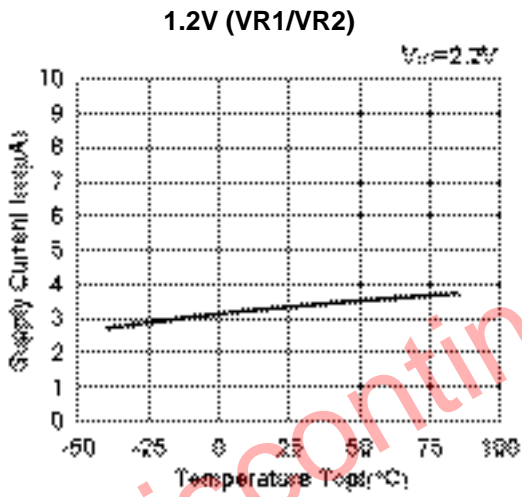

7) Dropout Voltage vs. Set Output Voltage ($T_{opt}=25^{\circ}C$)

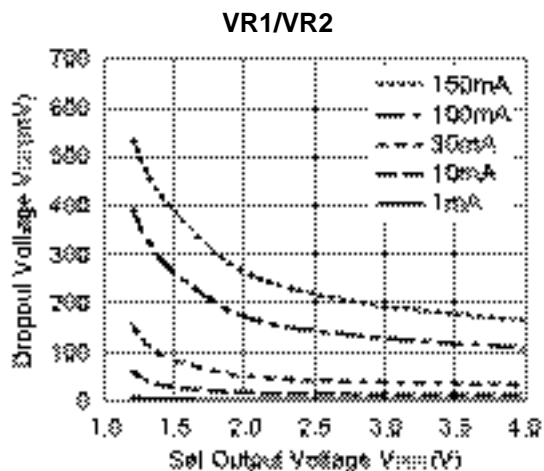

8) Ripple Rejection vs. Frequency ($T_{opt}=25^{\circ}C$, $C_{OUT}=0.1\mu F$)

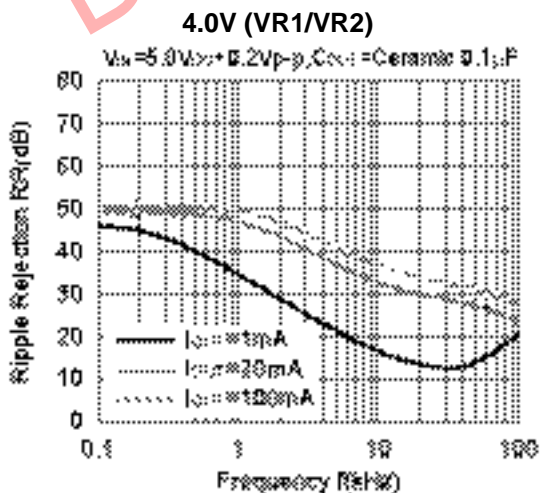
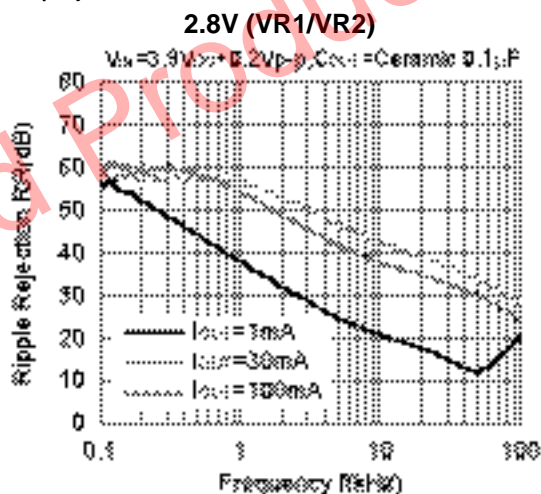
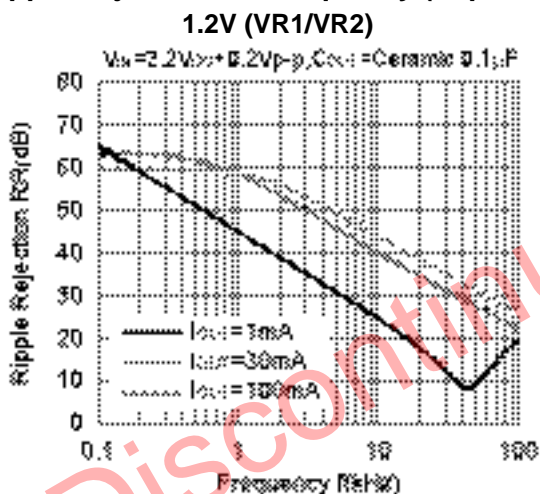

9) Ripple Rejection vs. Input Voltage (DC bias) (T_{opt}=25°C, Ripple 0.2Vp-p)

2.8V (VR1/VR2)

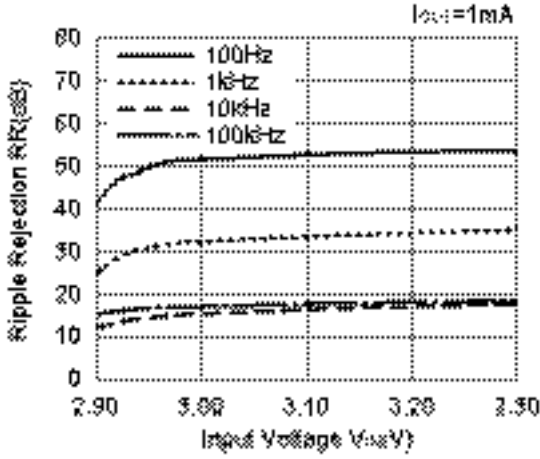

2.8V (VR1/VR2)

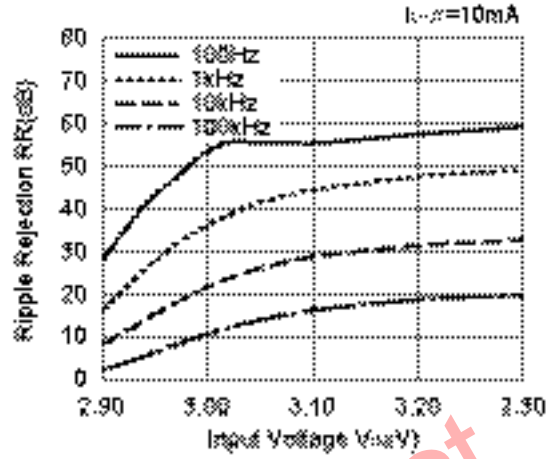

2.8V (VR1/VR2)

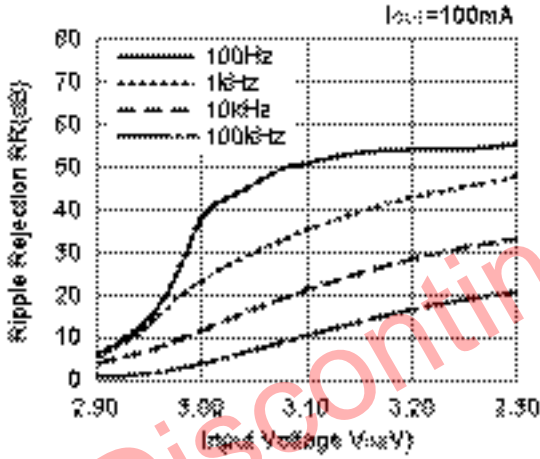

10) Input Transient Response (C_{IN}=none, tr=tf=5μs, I_{OUT}=30mA)

1.2V (VR1/VR2)

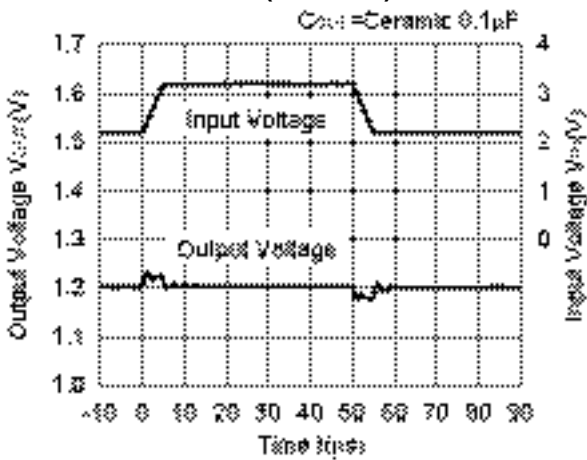

1.2V (VR1/VR2)

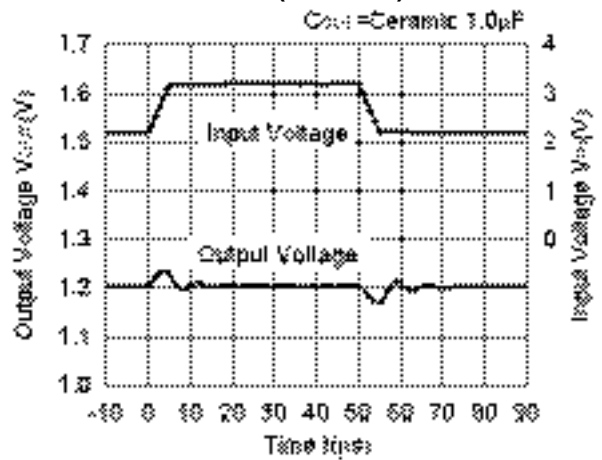

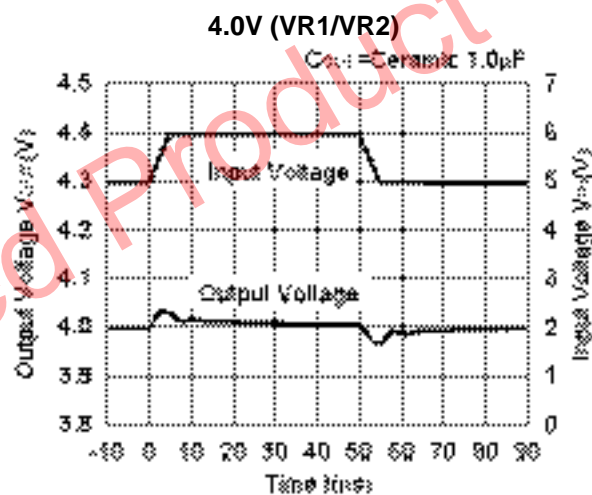
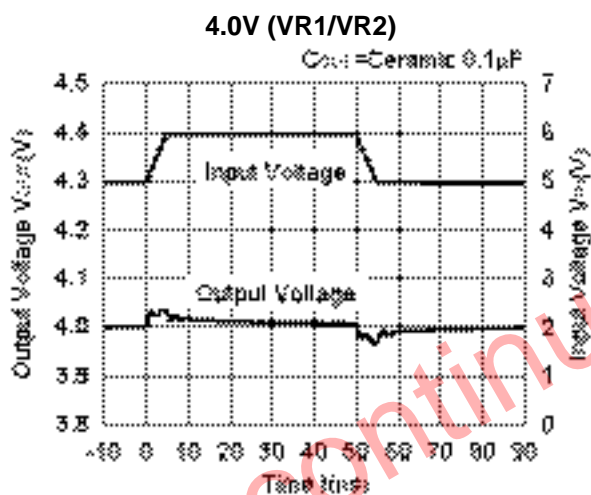
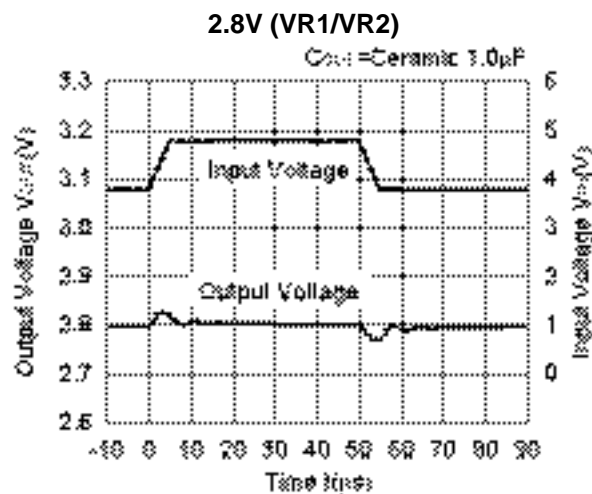
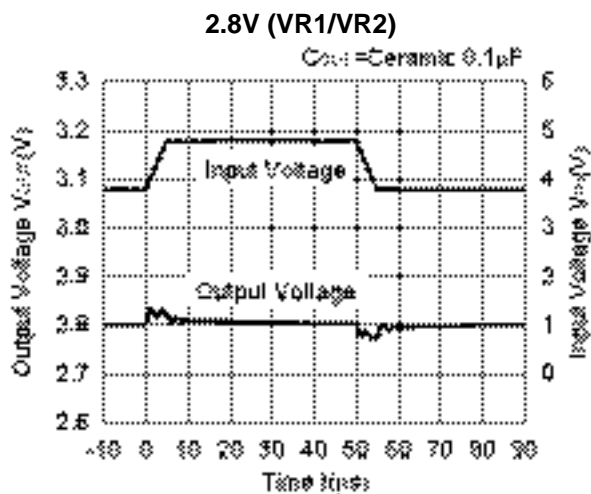

11) Load Transient Response (C_{in} =Ceramic 0.1 μ F)

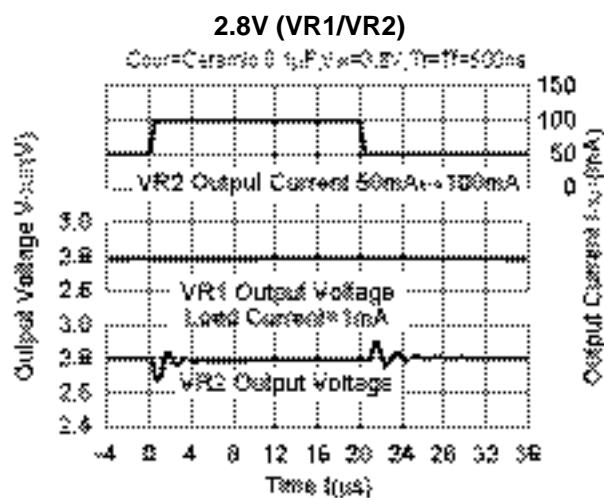
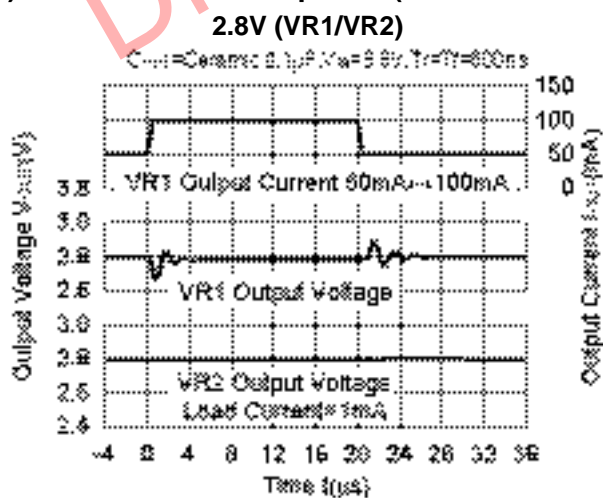

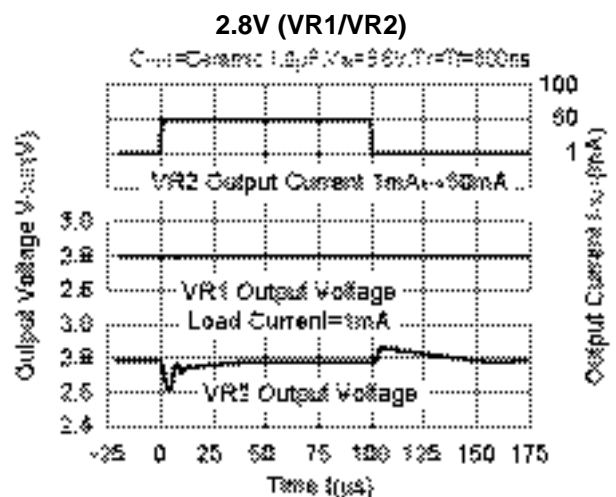
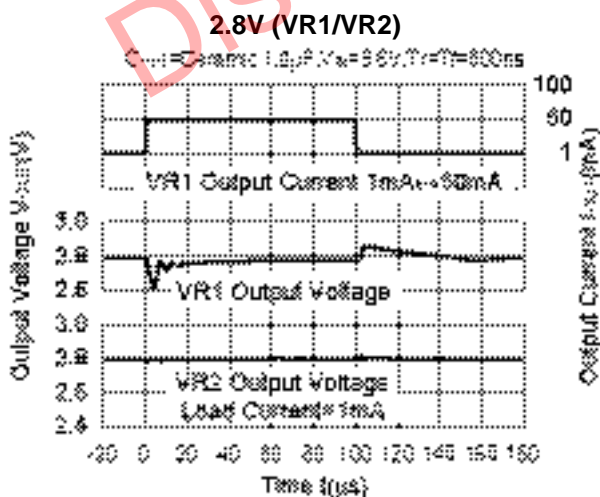
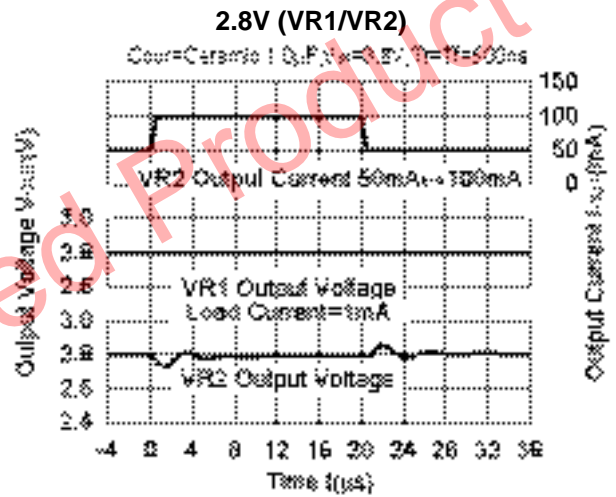
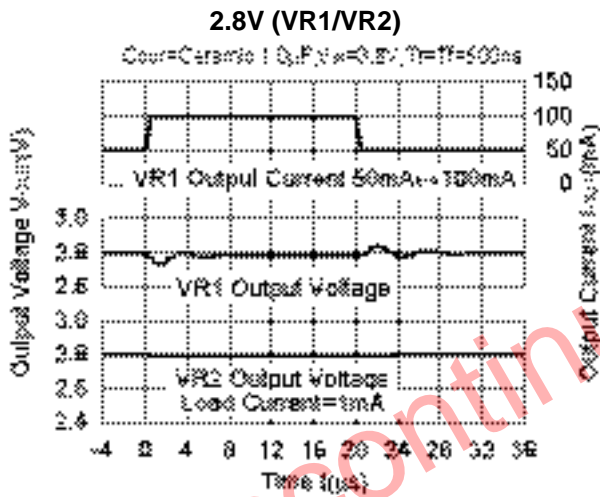
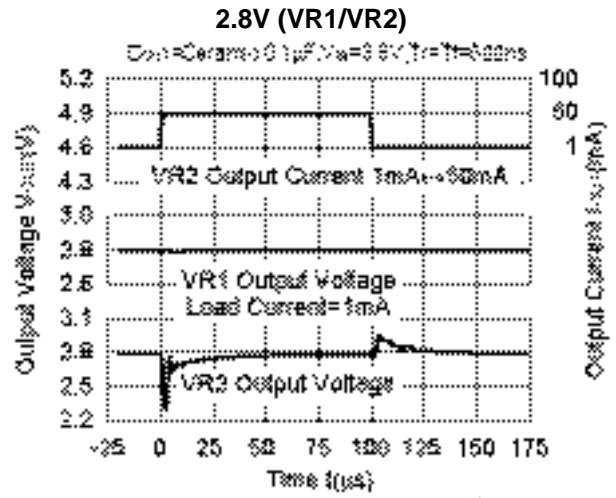
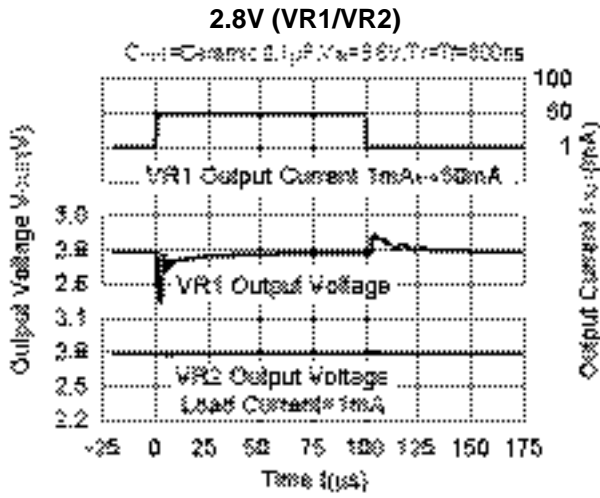

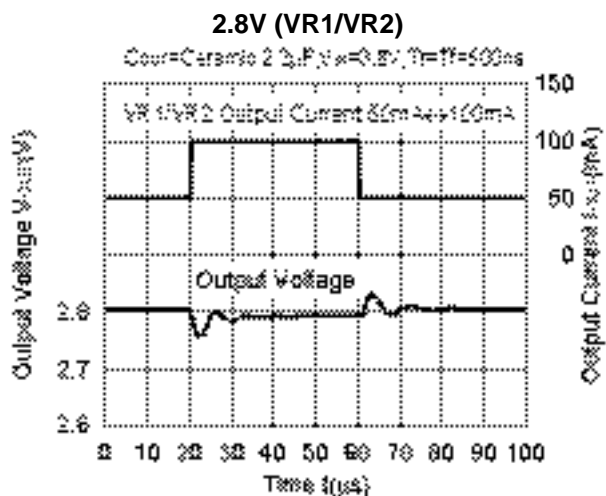

12) Turn on Speed by CE signal (C_{IN} =Ceramic 0.1 μ F)

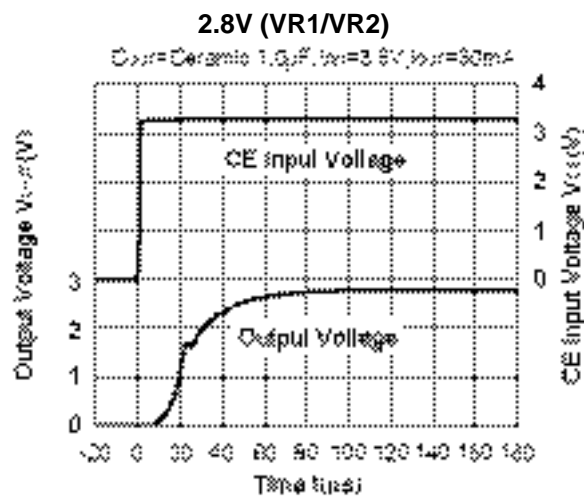
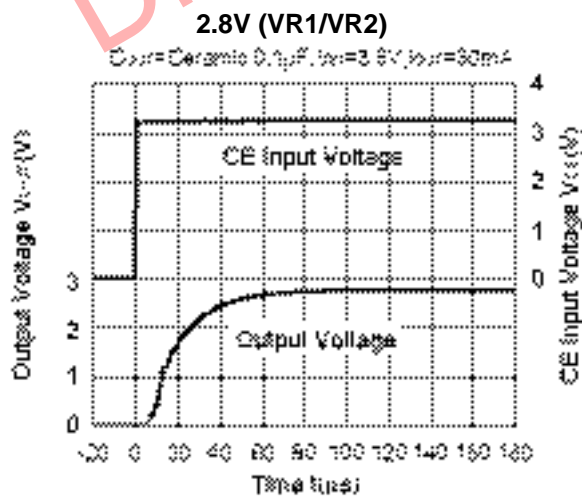
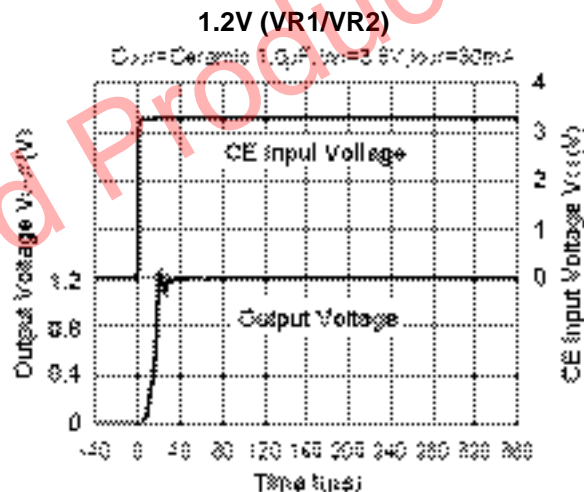
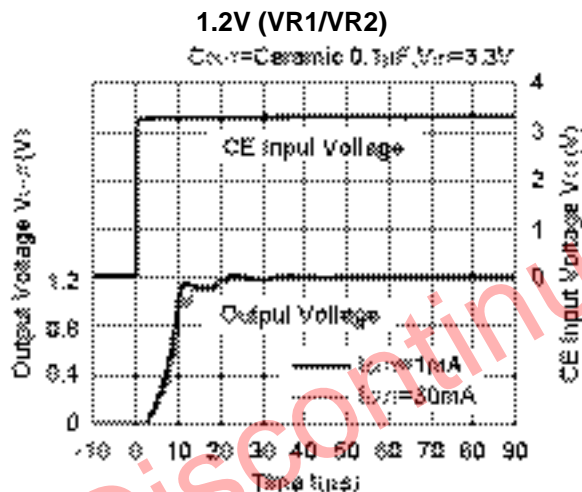

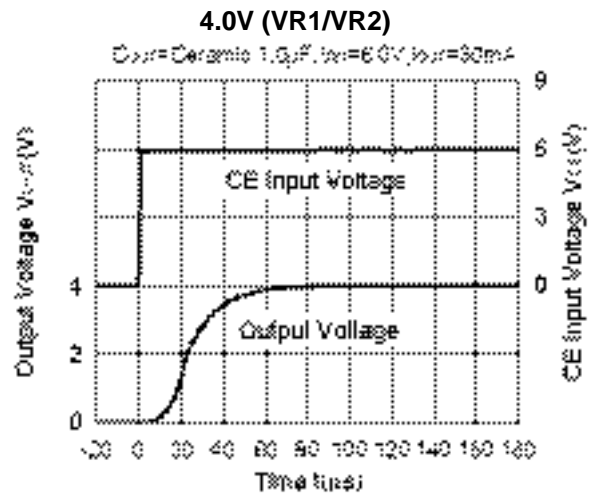
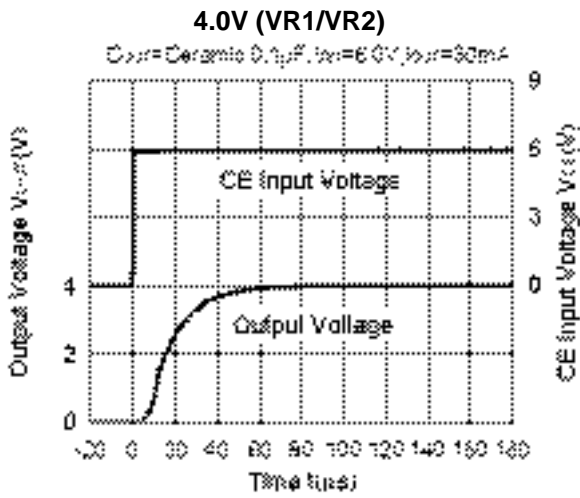

13) Turn-off Speed with CE Signal (B version) (C_{IN} =Ceramic 0.1 μ F)

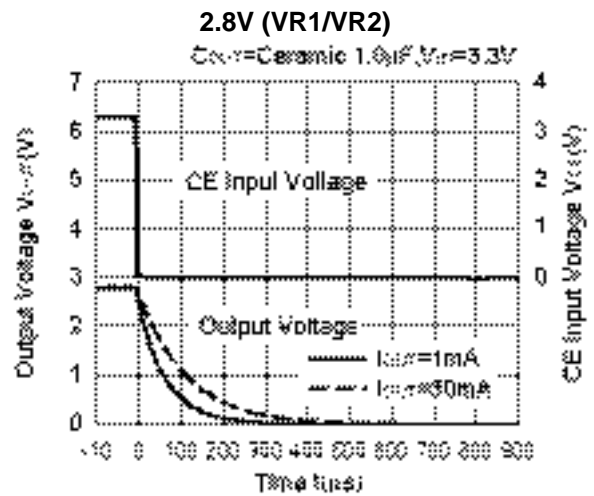
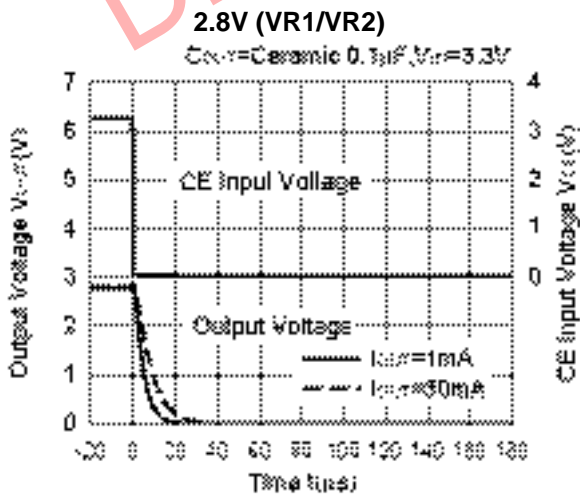
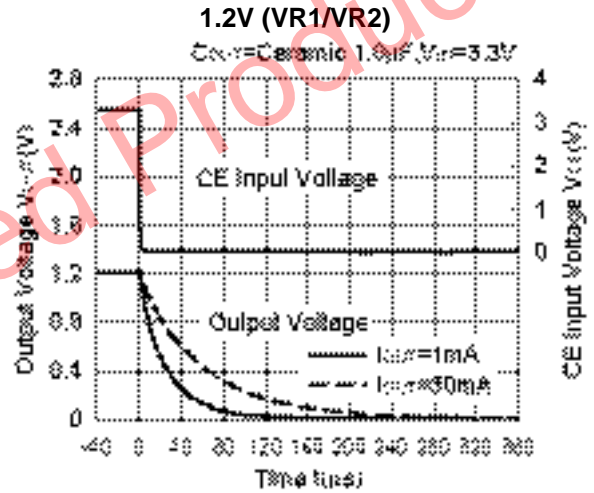
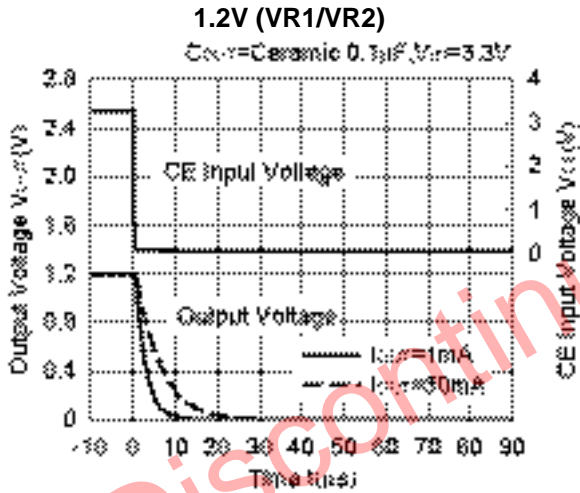

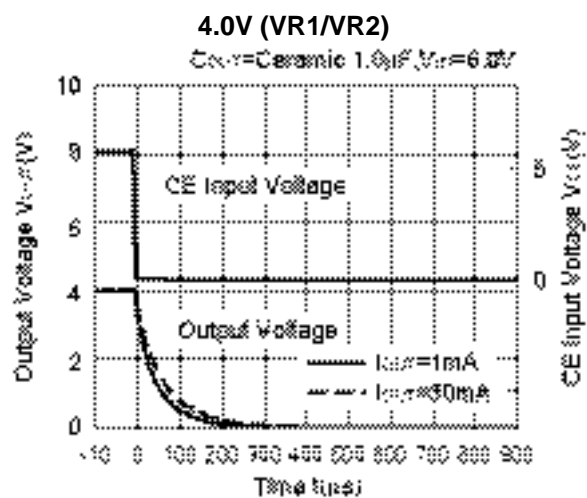
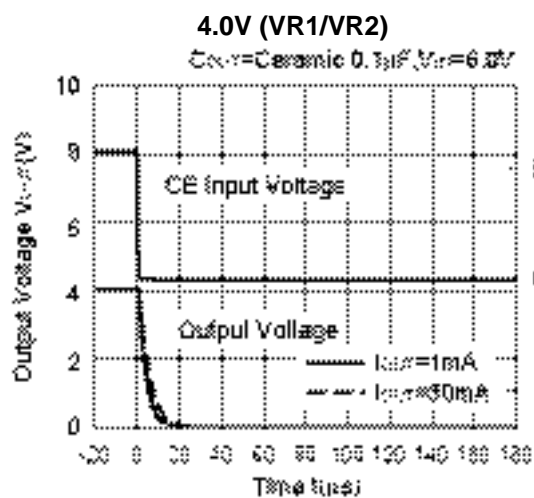

Discontinued Product



1. The products and the product specifications described in this document are subject to change or discontinuation of production without notice for reasons such as improvement. Therefore, before deciding to use the products, please refer to Ricoh sales representatives for the latest information thereon.
2. The materials in this document may not be copied or otherwise reproduced in whole or in part without prior written consent of Ricoh.
3. Please be sure to take any necessary formalities under relevant laws or regulations before exporting or otherwise taking out of your country the products or the technical information described herein.
4. The technical information described in this document shows typical characteristics of and example application circuits for the products. The release of such information is not to be construed as a warranty of or a grant of license under Ricoh's or any third party's intellectual property rights or any other rights.
5. The products listed in this document are intended and designed for use as general electronic components in standard applications (office equipment, telecommunication equipment, measuring instruments, consumer electronic products, amusement equipment etc.). Those customers intending to use a product in an application requiring extreme quality and reliability, for example, in a highly specific application where the failure or misoperation of the product could result in human injury or death (aircraft, spacevehicle, nuclear reactor control system, traffic control system, automotive and transportation equipment, combustion equipment, safety devices, life support system etc.) should first contact us.
6. We are making our continuous effort to improve the quality and reliability of our products, but semiconductor products are likely to fail with certain probability. In order to prevent any injury to persons or damages to property resulting from such failure, customers should be careful enough to incorporate safety measures in their design, such as redundancy feature, fire containment feature and fail-safe feature. We do not assume any liability or responsibility for any loss or damage arising from misuse or inappropriate use of the products.
7. Anti-radiation design is not implemented in the products described in this document.
8. The X-ray exposure can influence functions and characteristics of the products. Confirm the product functions and characteristics in the evaluation stage.
9. WLCSP products should be used in light shielded environments. The light exposure can influence functions and characteristics of the products under operation or storage.
10. There can be variation in the marking when different AOI (Automated Optical Inspection) equipment is used. In the case of recognizing the marking characteristic with AOI, please contact Ricoh sales or our distributor before attempting to use AOI.
11. Please contact Ricoh sales representatives should you have any questions or comments concerning the products or the technical information.



Ricoh is committed to reducing the environmental loading materials in electrical devices with a view to contributing to the protection of human health and the environment.

Ricoh has been providing RoHS compliant products since April 1, 2006 and Halogen-free products since April 1, 2012.

RICOH RICOH ELECTRONIC DEVICES CO., LTD.

<http://www.e-devices.ricoh.co.jp/en/>

Sales & Support Offices

RICOH ELECTRONIC DEVICES CO., LTD.

Higashi-Shinagawa Office (International Sales)
3-32-3, Higashi-Shinagawa, Shinagawa-ku, Tokyo 140-8655, Japan
Phone: +81-3-5479-2857 Fax: +81-3-5479-0502

RICOH EUROPE (NETHERLANDS) B.V.

Semiconductor Support Centre
Prof. W.H. Keesomlaan 1, 1183 DJ Amstelveen, The Netherlands
Phone: +31-20-5474-309

RICOH INTERNATIONAL B.V. - German Branch

Semiconductor Sales and Support Centre
Oberrather Strasse 6, 40472 Düsseldorf, Germany
Phone: +49-211-6546-0

RICOH ELECTRONIC DEVICES KOREA CO., LTD.

3F, Haesung Bldg, 504, Teheran-ro, Gangnam-gu, Seoul, 135-725, Korea
Phone: +82-2-2135-5700 Fax: +82-2-2051-5713

RICOH ELECTRONIC DEVICES SHANGHAI CO., LTD.

Room 403, No.2 Building, No.690 Bibo Road, Pu Dong New District, Shanghai 201203, People's Republic of China
Phone: +86-21-5027-3200 Fax: +86-21-5027-3299

RICOH ELECTRONIC DEVICES CO., LTD.

Taipei office
Room 109, 10F-1, No.51, Hengyang Rd., Taipei City, Taiwan (R.O.C.)
Phone: +886-2-2313-1621/1622 Fax: +886-2-2313-1623