

---

### OUTPUT CAPACITOR-LESS/LOW VOLTAGE 200mA LDO REGULATOR

---

NO.EA-181-170424

#### OUTLINE

The RP107x Series are CMOS-based LDO regulators featuring 200mA output.

Since the output capacitor and noise bypass capacitor are able to be reduced and the packages are small DFN(PLP)1212-6, WLCSP-4-P5, and SC-88A, high density mounting on boards are possible. The input voltage ( $V_{IN}$ ) is as low as Min.1.4V and the output voltage can be set from 1.0V.

Supply current is as low as 9.5 $\mu$ A compared to existing lines. The CE pin can switch the regulator to standby mode.

#### FEATURES

- Supply Current ..... Typ. 9.5 $\mu$ A
- Standby Mode ..... Typ. 0.1 $\mu$ A
- Dropout Voltage..... Typ. 0.27V ( $I_{OUT}=200mA$ ,  $V_{OUT}=3.0V$ )
- Ripple Rejection ..... Typ. 70dB ( $f=1kHz$ ,  $V_{OUT}\leq 1.2V$ )  
Typ. 65dB ( $f=1kHz$ ,  $1.2V < V_{OUT} < 2.2V$ )  
Typ. 60dB ( $f=1kHz$ ,  $V_{OUT}\geq 2.2V$ )
- Temperature-Drift Coefficient of Output Voltage ..... Typ.  $\pm 100ppm/^{\circ}C$
- Line Regulation ..... Typ. 0.02%/V
- Output Voltage Accuracy .....  $\pm 1.0\%$
- Packages..... WLCSP-4-P5, DFN(PLP)1212-6, SC-88A, SOT-23-5
- Input Voltage Range..... 1.4V to 5.25V
- Output Voltage Range..... 1.0V to 4.2V (0.1V steps)  
(For other voltages, please refer to MARK INFORMATIONS.)
- Built-in Fold Back Protection Circuit..... Typ. 50mA (Current at short mode)
- Output capacitor free and noise bypass capacitor free

#### APPLICATIONS

- Power source for portable communication equipment.
- Power source for electrical appliances such as cameras, VCRs and camcorders.
- Power source for battery-powered equipment.
- Power source for home appliances.

## RP107x

NO.EA-181-170424

## BLOCK DIAGRAMS

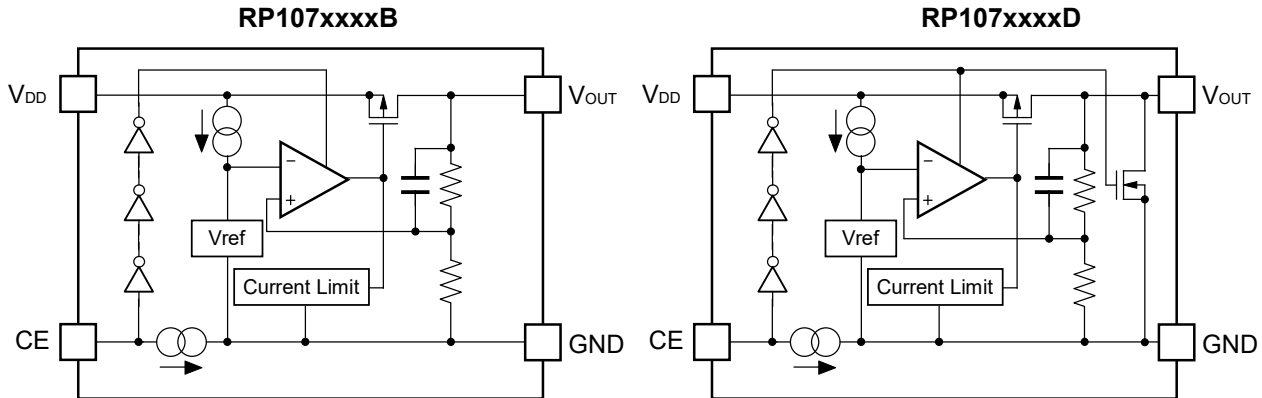

## SELECTION GUIDE

The output voltage, auto discharge function, package, and the taping type, etc. for the ICs can be selected at the user's request.

Product Name	Package	Quantity per Reel	Pb Free	Halogen Free
RP107Zxx1*(y)-TR-F	WLCSP-4-P5	5,000 pcs	Yes	Yes
RP107Kxx1*(y)-TR	DFN(PLP)1212-6	5,000 pcs	Yes	Yes
RP107Qxx2*(y)-TR-FE	SC-88A	3,000 pcs	Yes	Yes
RP107Nxx1*(y)-TR-FE	SOT-23-5	3,000 pcs	Yes	Yes

xx: The output voltage ( $V_{OUT}$ ) can be designated in the range from 1.0V to 4.2V in 0.1V steps.

(y): If the output voltage includes the 3<sup>rd</sup> digit, indicate the digit of 0.01V.

1.25V: RP107x12x\*5

1.85V: RP107x18x\*5

2.85V: RP107x28x\*5

\*: Select (B) without auto-discharge function or (D) with auto-discharge function.

\*1 Auto-discharge function quickly lowers the output voltage to 0V by releasing the electrical charge accumulated in the external capacitor when the chip enable signal is switched from the active mode to the standby mode.

## PIN CONFIGURATIONS

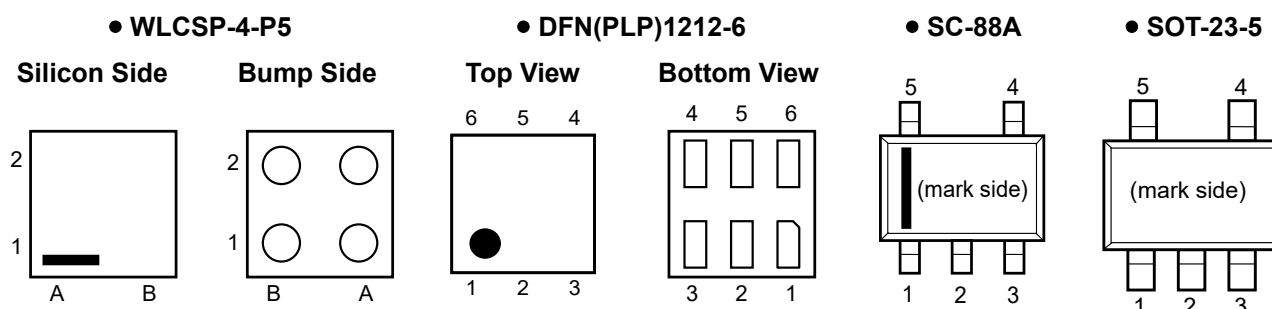

## PIN DESCRIPTIONS

### • WLCSP-4-P5

Pin No	Symbol	Pin Description
A1	$V_{DD}$	Input Pin
A2	$V_{OUT}$	Output Pin
B1	CE	Chip Enable Pin
B2	GND	Ground Pin

### • DFN(PLP)1212-6

Pin No	Symbol	Pin Description
1	NC	No Connection
2	GND	Ground Pin
3	CE	Chip Enable Pin
4	$V_{DD}$	Input Pin
5	NC	No Connection
6	$V_{OUT}$	Output Pin

### • SC-88A

Pin No	Symbol	Pin Description
1	CE	Chip Enable Pin
2*	NC	No Connection
3	GND	Ground Pin
4	$V_{OUT}$	Output Pin
5	$V_{DD}$	Input Pin

\* Pin No. 2 is connected to the bottom of the IC. It is recommended that the pin be connected to the ground plane on the board, or otherwise be left floating so that there is no contact with other potentials.

\*RP107N (SOT-23-5) is the non-promotion product as of April 2017.

## RP107x

NO.EA-181-170424

### • SOT-23-5

Pin No	Symbol	Pin Description
1	V <sub>DD</sub>	Input Pin
2	GND	Ground Pin
3	CE	Chip Enable Pin
4	NC	No Connection
5	V <sub>OUT</sub>	Output Pin

## ABSOLUTE MAXIMUM RATINGS

Symbol	Item	Rating	Unit
V <sub>IN</sub>	Input Voltage	6.0	V
V <sub>CE</sub>	Input Voltage (CE Pin)	-0.3 to 6.0	V
V <sub>OUT</sub>	Output Voltage	-0.3 to V <sub>IN</sub> +0.3	V
I <sub>OUT</sub>	Output Current	400	mA
P <sub>D</sub>	Power Dissipation* (WLCSP-4-P5)	278	mW
	Power Dissipation* (DFN(PLP)1212-6)	400	
	Power Dissipation* (SC-88A)	380	
	Power Dissipation* (SOT-23-5)	420	
T <sub>opt</sub>	Operating Temperature Range	-40 to 85	°C
T <sub>stg</sub>	Storage Temperature Range	-55 to 125	°C

\*) For Power Dissipation, please refer to PACKAGE INFORMATION.

### ABSOLUTE MAXIMUM RATINGS

Electronic and mechanical stress momentarily exceeded absolute maximum ratings may cause the permanent damages and may degrade the life time and safety for both device and system using the device in the field.

The functional operation at or over these absolute maximum ratings is not assured.

## ELECTRICAL CHARACTERISTICS

### • RP107xxxxB/D

$V_{IN} = V_{SET}^{*3} + 1.0V$ ,  $I_{OUT} = 1mA$ ,  $C_{IN} = C_{OUT} = 0.1\mu F$ , unless otherwise noted.

The specifications surrounded by   are guaranteed by Design Engineering at  $-40^{\circ}C \leq T_a \leq 85^{\circ}C$ .

#### RP107x Series

( $T_a = 25^{\circ}C$ )

Symbol	Item	Conditions	Min.	Typ.	Max.	Unit	
$V_{OUT}$	Output Voltage	$T_a = 25^{\circ}C$	$V_{SET} > 2.0V$	x 0.990		x 1.010	V
			$V_{SET} \leq 2.0V$	-20		+20	mV
		$-40^{\circ}C \leq T_a \leq 85^{\circ}C$	$V_{SET} > 2.0V$	<span style="border: 1px solid black; padding: 0 2px;">x 0.980</span>		<span style="border: 1px solid black; padding: 0 2px;">x 1.015</span>	V
			$V_{SET} \leq 2.0V$	<span style="border: 1px solid black; padding: 0 2px;">-40</span>		<span style="border: 1px solid black; padding: 0 2px;">+30</span>	mV
$I_{OUT}$	Output Current		<span style="border: 1px solid black; padding: 0 2px;">200</span>			mA	
$\frac{\Delta V_{OUT}}{\Delta I_{OUT}}$	Load Regulation	$1mA \leq I_{OUT} \leq 200mA$		25	<span style="border: 1px solid black; padding: 0 2px;">50</span>	mV	
$V_{DIF}$	Dropout Voltage	Refer to <i>Dropout Voltage Specifications</i> .					
$I_{SS}$	Supply Current ( $I_{OUT} = 0mA$ )	$I_{OUT} = 0mA$		9.5	<span style="border: 1px solid black; padding: 0 2px;">25</span>	$\mu A$	
$I_{standby}$	Standby Current	$V_{CE} = GND$		0.1	3.0	$\mu A$	
$\frac{\Delta V_{OUT}}{\Delta V_{IN}}$	Line Regulation	$V_{SET} + 0.5V \leq V_{IN} \leq 5V$ $I_{OUT} = 1mA$		$\pm 0.02$	<span style="border: 1px solid black; padding: 0 2px;">±0.20</span>	%/V	
RR	Ripple Rejection	$f = 1kHz$ ( $V_{OUT} \leq 1.2V$ ) $f = 1kHz$ ( $1.2V < V_{OUT} < 2.2V$ ) $f = 1kHz$ ( $V_{OUT} \leq 2.2V$ ) Ripple 0.2Vp-p $V_{IN} = V_{SET} + 1.0V$ $I_{OUT} = 30mA$ Note: When $V_{OUT} \leq 1.2V$ , $V_{IN} = 2.2V$ .		70 65 60		dB	
$V_{IN}$	Input Voltage		<span style="border: 1px solid black; padding: 0 2px;">1.4</span>		<span style="border: 1px solid black; padding: 0 2px;">5.25</span>	V	
$\frac{\Delta V_{OUT}}{\Delta T_a}$	Output Voltage Temperature Coefficient	$-40^{\circ}C \leq T_a \leq 85^{\circ}C$		$\pm 100$		ppm/ $^{\circ}C$	
$I_{SC}$	Short Current Limit	$V_{OUT} = 0V$		50		mA	
$I_{CEPD}$	CE Pull-down Current			0.1		$\mu A$	
$V_{CEH}$	CE Input Voltage "H"		<span style="border: 1px solid black; padding: 0 2px;">1.0</span>			V	
$V_{CEL}$	CE Input Voltage "L"				<span style="border: 1px solid black; padding: 0 2px;">0.4</span>	V	
$R_{LOW}$	Auto-discharge Nch ON Resistance (D version only)	$V_{IN} = 4.0V$ $V_{CE} = 0V$		30		$\Omega$	

All test items listed under [7] *Electrical Characteristics* are done under the pulse load condition ( $T_j \approx T_a = 25^{\circ}C$ ) except for Ripple Rejection and Output Voltage Temperature Coefficient.

\*3  $V_{SET}$  = Set Output Voltage

\*RP107N (SOT-23-5) is the non-promotion product as of April 2017.

**RP107x**

NO.EA-181-170424

The specifications surrounded by   are guaranteed by Design Engineering at  $-40^{\circ}\text{C} \leq T_a \leq 85^{\circ}\text{C}$ .

**Dropout Voltage Specifications**

( $t_a=25^{\circ}\text{C}$ )

Output Voltage $V_{\text{SET}}$ (V)	Dropout Voltage $V_{\text{DIF}}$ (V)	
	Condition	Typ. Max.
$1.0 \leq V_{\text{SET}} < 1.1$	$I_{\text{OUT}} = 200\text{mA}$	0.64 <span style="float: right; border: 1px solid black; padding: 0 2px;">0.92</span>
$1.1 \leq V_{\text{SET}} < 1.2$		0.59 <span style="float: right; border: 1px solid black; padding: 0 2px;">0.84</span>
$1.2 \leq V_{\text{SET}} < 1.5$		0.55 <span style="float: right; border: 1px solid black; padding: 0 2px;">0.76</span>
$1.5 \leq V_{\text{SET}} < 2.0$		0.44 <span style="float: right; border: 1px solid black; padding: 0 2px;">0.60</span>
$2.0 \leq V_{\text{SET}} < 2.6$		0.35 <span style="float: right; border: 1px solid black; padding: 0 2px;">0.49</span>
$2.6 \leq V_{\text{SET}}$		0.27 <span style="float: right; border: 1px solid black; padding: 0 2px;">0.36</span>

**RECOMMENDED OPERATING CONDITIONS (ELECTRICAL CHARACTERISTICS)**

All of electronic equipment should be designed that the mounted semiconductor devices operate within the recommended operating conditions. The semiconductor devices cannot operate normally over the recommended operating conditions, even if when they are used over such conditions by momentary electronic noise or surge. And the semiconductor devices may receive serious damage when they continue to operate over the recommended operating conditions.

## TYPICAL APPLICATION

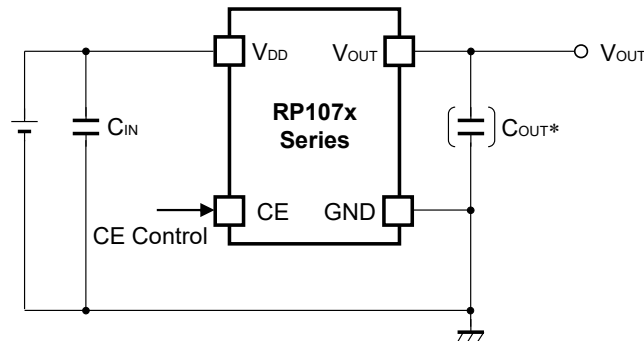

## TECHNICAL NOTES

When using the RP107x Series, please note the following points.

### \*Phase Compensation

The RP107x Series are using an output capacitor as phase compensation to ensure a stable operation even if the output load fluctuates. To reduce the output voltage fluctuation, it is imperative that a 0.1 $\mu$ F to 10 $\mu$ F output capacitor be used. When doing so, please note the following three points.

1. If the output capacitor is 2.2 $\mu$ F or more and the output current is 0.01mA or less\*<sub>1</sub>, the noise level may increase beyond 40 $\mu$ V, therefore, it is imperative that the stability of operation including the frequency characteristics be evaluated.
2. If the output capacitor is 0.01 $\mu$ F or less and the output current is 0.1mA or less\*<sub>2</sub>, the exogenous noise occurred in the other circuits may give some impacts on the noise level, therefore it is imperative that the enough measures be taken such as to make GND lowered.

As for 1 and 2, please refer to the chart of the External Capacitor vs. Output Voltage.

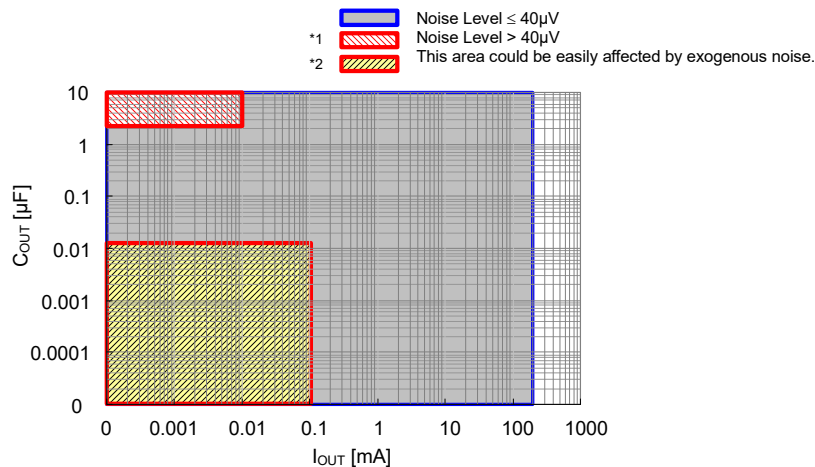

External Capacitor vs. Output Voltage

3. In case of using a tantalum capacitor, the output may oscillate if the effective series resistance (ESR) is high, therefore, it is imperative that the ESR vs. Frequency be considered.

### PCB Layout

If the impedances of V<sub>DD</sub> and GND lines are high, the ICs may pick up noise or may cause unstable operation when the current flows. Therefore, make V<sub>DD</sub> and GND the lowest possible. Also, place a 0.1 $\mu$ F or more C<sub>IN</sub> capacitor between V<sub>DD</sub> pin and GND pin as close as possible to each other.

## RP107x

NO.EA-181-170424

### CONSTANT SLOPE CIRCUITS

The RP107x Series is equipped with a constant slope circuit as a soft-start circuit, which allows the output voltage to start up gradually when the CE is turned on. The constant slope circuit minimizes the inrush current at the start-up and also prevents the overshoot of the output voltage. The capacitor to create the start-up slope is built in the IC that does not require any external components. The start-up time and the start-up slope angle are fixed inside the IC.

If the capacitance of the external output capacitor ( $C_{OUT}$ ) becomes more than the certain capacitance, the output current limit circuit minimizes the incoming current of the output capacitor at the start-up. As a result, the start-up time becomes longer and the start-up slope angle becomes more gentle. As “Inrush Current Characteristics Example” below shows, if the  $C_{OUT}$  is less than  $2.2\mu\text{F}$ , the constant slope circuit easily starts to function at the start-up, likewise, if the  $C_{OUT}$  is over  $4.7\mu\text{F}$ , the output current limit circuit easily starts to function at the start-up. The boundary point of using these two circuits is inversely proportional to the output voltage. If the output voltage is higher, the output current limit circuit easily starts to function even if the  $C_{OUT}$  capacitance is small. For more details, please refer to the graph 15 of “Inrush Current Characteristics Example”.

**Inrush Current Characteristics Example ( $C_1=0.1\mu\text{F}$ ,  $T_{opt}=25^\circ\text{C}$ )**

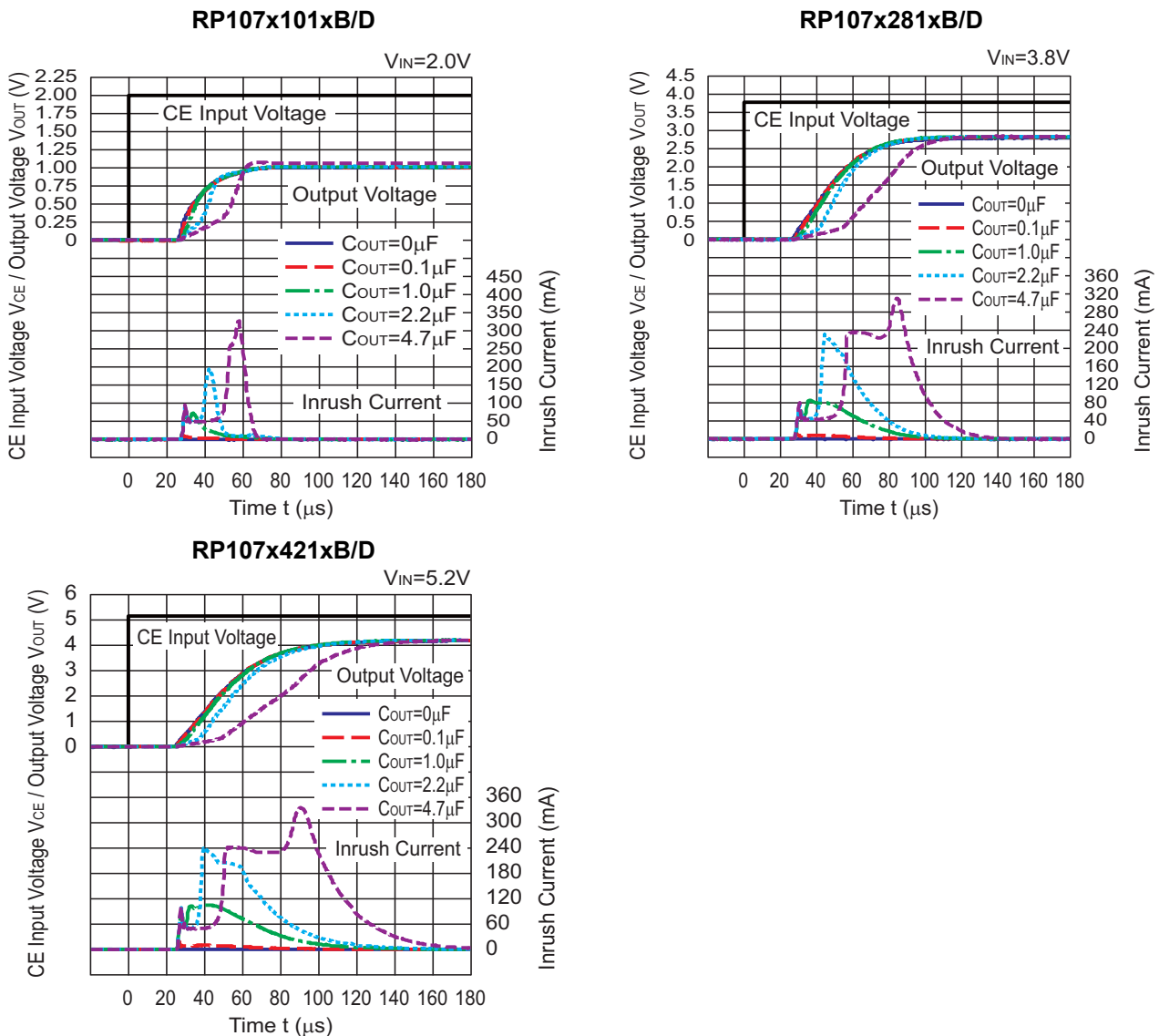



## PACKAGE INFORMATION

### • Power Dissipation (WLCSP-4-P5)

Power Dissipation ( $P_D$ ) depends on conditions of mounting on board. This specification is based on the Measurement Conditions below.

#### Measurement Conditions

	Standard Land Pattern
Environment	Mounting on Board (Wind Velocity=0m/s)
Board Material	Glass Cloth Epoxy Plastic (Double-sided)
Board Dimensions	40mm x 40mm x 1.6mm
Copper Ratio	Topside: Approx. 50%, Backside: Approx. 50%
Through-hole	$\phi$ 0.5mm x 28pcs

#### Measurement Result

( $T_a=25^\circ\text{C}$ ,  $T_{j\text{max}}=125^\circ\text{C}$ )

	Standard Land Pattern
Power Dissipation	278mW
Thermal Resistance	$\theta_{ja}=(125-25^\circ\text{C})/0.278\text{W}=360^\circ\text{C/W}$
	$\theta_{jc}= 46^\circ\text{C/W}$

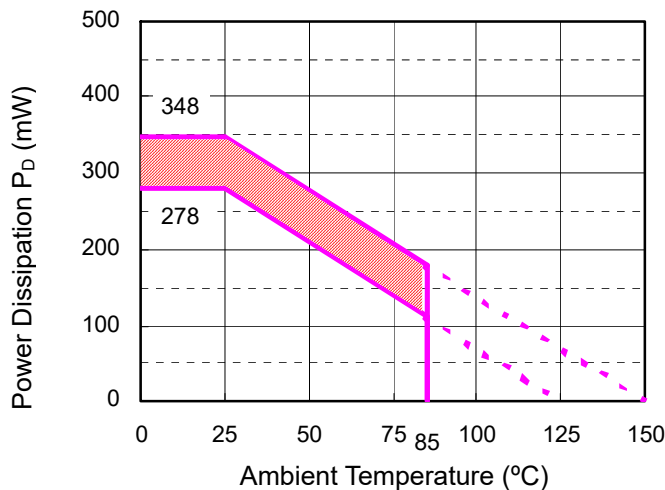

**Power Dissipation**

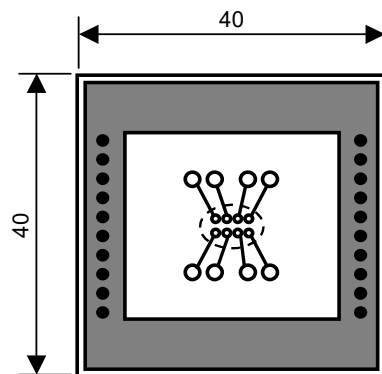

**Measurement Board Pattern**

IC Mount Area (Unit: mm)

The above graph shows the Power Dissipation of the WLCSP-4-P5 package based on  $T_{j\text{max}}=125^\circ\text{C}$  and  $T_{j\text{max}}=150^\circ\text{C}$ . Operating the ICs within the shaded area in the graph might have an influence on the lifetime of the ICs. Operating time must be within the time limit described in the table below.

Operating Time	Estimated Years (Operating 4 hrs/ day)
13,000 Hours	9 Years

**RP107x**

NO.EA-181-170424

• **Package Dimensions (WLCSP-4-P5)**

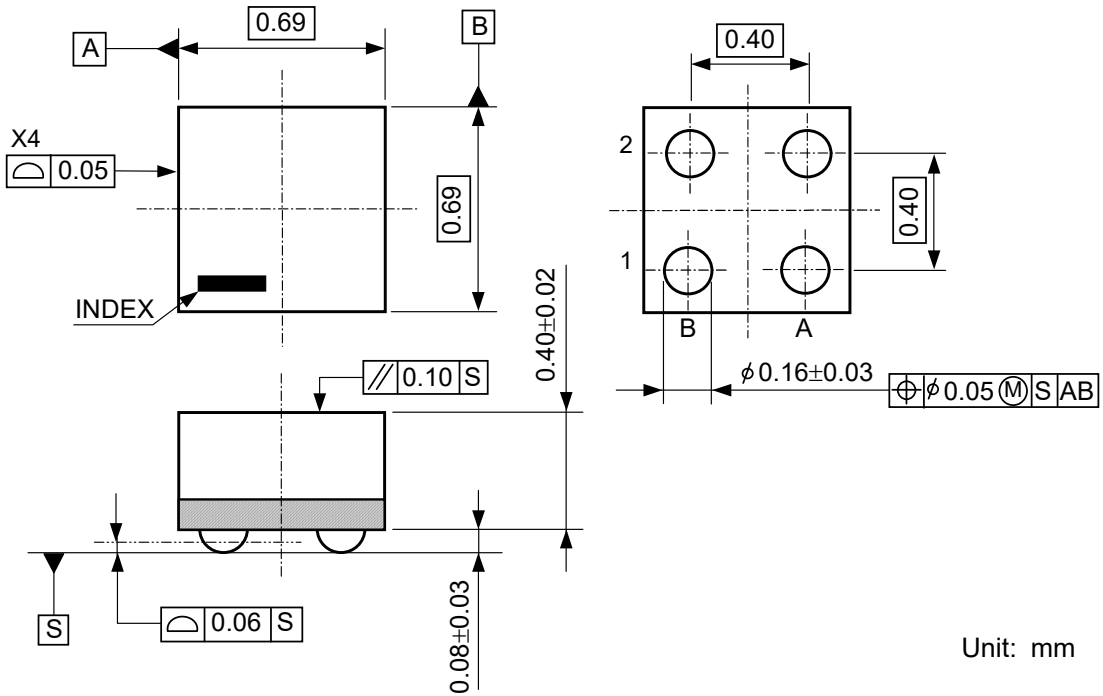

Unit: mm

• **Mark Specification (WLCSP-4-P5)**

①②: Lot Number ... Alphanumeric Serial Number

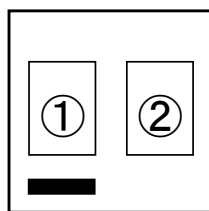

● **RP107Z Series Mark Specification Table (WLCSP-4-P5)**

<b>RP107ZxxxB</b>		<b>RP107ZxxxD</b>	
<b>Product Name</b>	<b>V<sub>SET</sub></b>	<b>Product Name</b>	<b>V<sub>SET</sub></b>
RP107Z101B	1.0V	RP107Z101D	1.0V
RP107Z111B	1.1V	RP107Z111D	1.1V
RP107Z121B	1.2V	RP107Z121D	1.2V
RP107Z131B	1.3V	RP107Z131D	1.3V
RP107Z141B	1.4V	RP107Z141D	1.4V
RP107Z151B	1.5V	RP107Z151D	1.5V
RP107Z161B	1.6V	RP107Z161D	1.6V
RP107Z171B	1.7V	RP107Z171D	1.7V
RP107Z181B	1.8V	RP107Z181D	1.8V
RP107Z191B	1.9V	RP107Z191D	1.9V
RP107Z201B	2.0V	RP107Z201D	2.0V
RP107Z211B	2.1V	RP107Z211D	2.1V
RP107Z221B	2.2V	RP107Z221D	2.2V
RP107Z231B	2.3V	RP107Z231D	2.3V
RP107Z241B	2.4V	RP107Z241D	2.4V
RP107Z251B	2.5V	RP107Z251D	2.5V
RP107Z261B	2.6V	RP107Z261D	2.6V
RP107Z271B	2.7V	RP107Z271D	2.7V
RP107Z281B	2.8V	RP107Z281D	2.8V
RP107Z291B	2.9V	RP107Z291D	2.9V
RP107Z301B	3.0V	RP107Z301D	3.0V
RP107Z311B	3.1V	RP107Z311D	3.1V
RP107Z321B	3.2V	RP107Z321D	3.2V
RP107Z331B	3.3V	RP107Z331D	3.3V
RP107Z341B	3.4V	RP107Z341D	3.4V
RP107Z351B	3.5V	RP107Z351D	3.5V
RP107Z361B	3.6V	RP107Z361D	3.6V
RP107Z371B	3.7V	RP107Z371D	3.7V
RP107Z381B	3.8V	RP107Z381D	3.8V
RP107Z391B	3.9V	RP107Z391D	3.9V
RP107Z401B	4.0V	RP107Z401D	4.0V
RP107Z411B	4.1V	RP107Z411D	4.1V
RP107Z421B	4.2V	RP107Z421D	4.2V
RP107Z121B5	1.25V	RP107Z121D5	1.25V
RP107Z181B5	1.85V	RP107Z181D5	1.85V
RP107Z281B5	2.85V	RP107Z281D5	2.85V

\*RP107N (SOT-23-5) is the non-promotion product as of April 2017.

**RP107x**

NO.EA-181-170424

● **Power Dissipation (DFN(PLP)1212-6)**

Power Dissipation ( $P_D$ ) depends on conditions of mounting on board. This specification is based on the Measurement Conditions below.

Measurement Conditions

	Standard Land Pattern
Environment	Mounting on Board (Wind Velocity=0m/s)
Board Material	Glass Cloth Epoxy Plastic (Double-sided)
Board Dimensions	40mm x 40mm x 1.6mm
Copper Ratio	Topside: Approx. 50%, Backside: Approx. 50%
Through-holes	$\phi$ 0.54mm x 28pcs

Measurement Result

( $T_a=25^\circ\text{C}$ ,  $T_{j\text{max}}=125^\circ\text{C}$ )

	Standard Land Pattern
Power Dissipation	400mW
Thermal Resistance	$\theta_{ja} = (125-25^\circ\text{C})/0.4\text{W} = 250^\circ\text{C/W}$
	$\theta_{jc} = 67^\circ\text{C/W}$

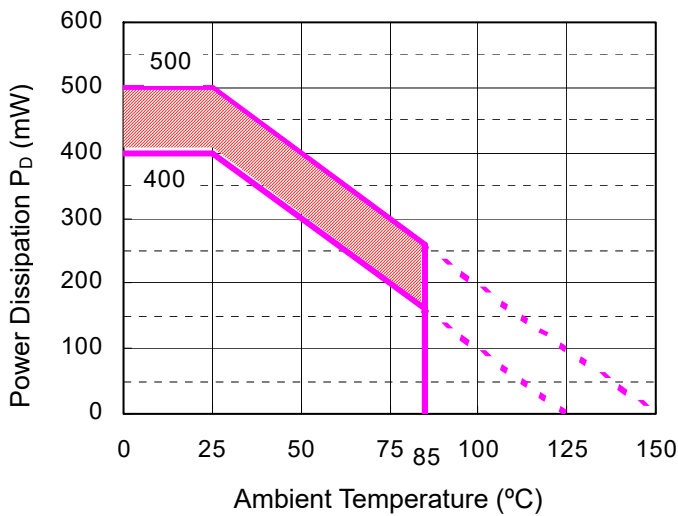

**Power Dissipation**

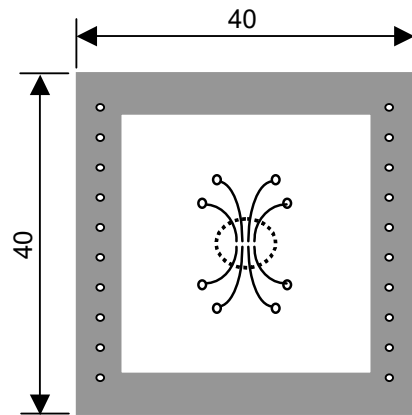

**Measurement Board Pattern**

○ IC Mount Area (Unit: mm)

The above graph shows the Power Dissipation of the DFN(PLP)1212-6 package based on  $T_{j\text{max}}=125^\circ\text{C}$  and  $T_{j\text{max}}=150^\circ\text{C}$ . Operating the ICs within the shaded area in the graph might have an influence on the lifetime of the ICs. Operating time must be within the time limit described in the table below.

Operating Time	Estimated Years (Operating 4 hrs/ day)
13,000 Hours	9 Years

• Package Dimensions (DFN(PLP)1212-6)

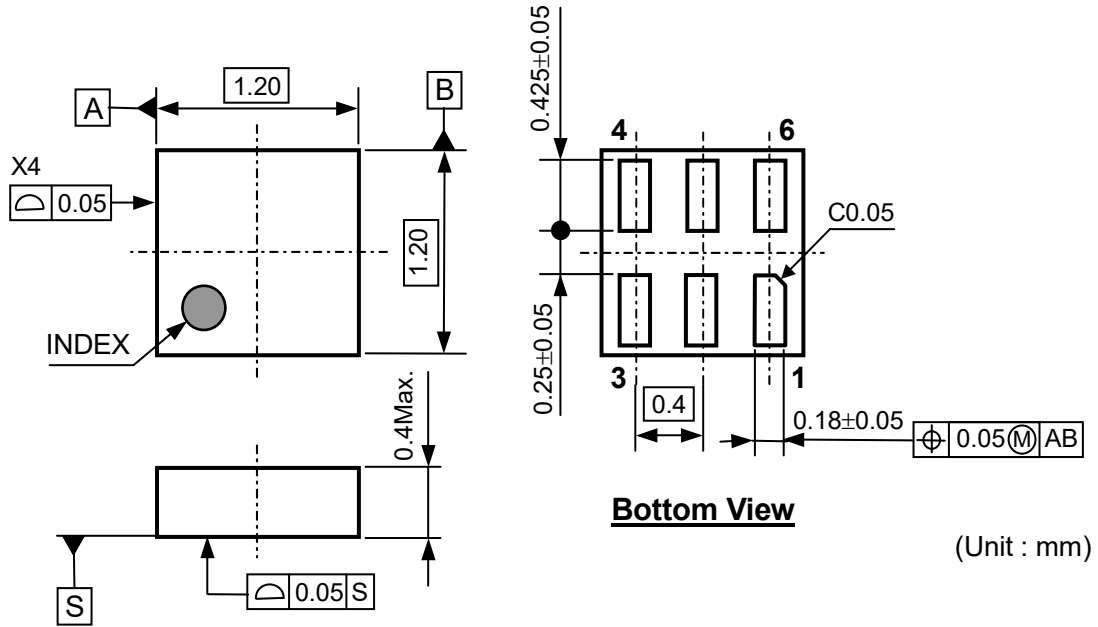

• Mark Specification (DFN(PLP)1212-6)

- ①②: Product Code ... Refer to RP107K Series Mark Specification Table.
- ③④: Lot Number ... Alphanumeric Serial Number

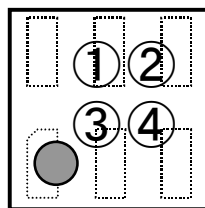

\*RP107N (SOT-23-5) is the non-promotion product as of April 2017.

## RP107x

NO.EA-181-170424

### ● RP107K Series Mark Specification Table (DFN(PLP)1212-6)

#### RP107KxxxB

Product Name	①②	V <sub>SET</sub>
RP107K101B	<b>JA</b>	1.0V
RP107K111B	<b>JB</b>	1.1V
RP107K121B	<b>JC</b>	1.2V
RP107K131B	<b>JD</b>	1.3V
RP107K141B	<b>JE</b>	1.4V
RP107K151B	<b>JF</b>	1.5V
RP107K161B	<b>JG</b>	1.6V
RP107K171B	<b>JH</b>	1.7V
RP107K181B	<b>JJ</b>	1.8V
RP107K191B	<b>JK</b>	1.9V
RP107K201B	<b>JL</b>	2.0V
RP107K211B	<b>JM</b>	2.1V
RP107K221B	<b>JN</b>	2.2V
RP107K231B	<b>JP</b>	2.3V
RP107K241B	<b>JQ</b>	2.4V
RP107K251B	<b>JR</b>	2.5V
RP107K261B	<b>JA</b>	2.6V
RP107K271B	<b>JT</b>	2.7V
RP107K281B	<b>JU</b>	2.8V
RP107K291B	<b>JV</b>	2.9V
RP107K301B	<b>JW</b>	3.0V
RP107K311B	<b>JX</b>	3.1V
RP107K321B	<b>JY</b>	3.2V
RP107K331B	<b>JZ</b>	3.3V
RP107K341B	<b>KA</b>	3.4V
RP107K351B	<b>KB</b>	3.5V
RP107K361B	<b>KC</b>	3.6V
RP107K371B	<b>KD</b>	3.7V
RP107K381B	<b>KE</b>	3.8V
RP107K391B	<b>KF</b>	3.9V
RP107K401B	<b>KG</b>	4.0V
RP107K411B	<b>KH</b>	4.1V
RP107K421B	<b>KJ</b>	4.2V
RP107K121B5	<b>KK</b>	1.25V
RP107K181B5	<b>KL</b>	1.85V
RP107K281B5	<b>KM</b>	2.85V

#### RP107KxxxD

Product Name	①②	V <sub>SET</sub>
RP107K101D	<b>LA</b>	1.0V
RP107K111D	<b>LB</b>	1.1V
RP107K121D	<b>LC</b>	1.2V
RP107K131D	<b>LD</b>	1.3V
RP107K141D	<b>LE</b>	1.4V
RP107K151D	<b>LF</b>	1.5V
RP107K161D	<b>LG</b>	1.6V
RP107K171D	<b>LH</b>	1.7V
RP107K181D	<b>LJ</b>	1.8V
RP107K191D	<b>LK</b>	1.9V
RP107K201D	<b>LL</b>	2.0V
RP107K211D	<b>LM</b>	2.1V
RP107K221D	<b>LN</b>	2.2V
RP107K231D	<b>LP</b>	2.3V
RP107K241D	<b>LQ</b>	2.4V
RP107K251D	<b>LR</b>	2.5V
RP107K261D	<b>LA</b>	2.6V
RP107K271D	<b>LT</b>	2.7V
RP107K281D	<b>LU</b>	2.8V
RP107K291D	<b>LV</b>	2.9V
RP107K301D	<b>LW</b>	3.0V
RP107K311D	<b>LX</b>	3.1V
RP107K321D	<b>LY</b>	3.2V
RP107K331D	<b>LZ</b>	3.3V
RP107K341D	<b>MA</b>	3.4V
RP107K351D	<b>MB</b>	3.5V
RP107K361D	<b>MC</b>	3.6V
RP107K371D	<b>MD</b>	3.7V
RP107K381D	<b>ME</b>	3.8V
RP107K391D	<b>MF</b>	3.9V
RP107K401D	<b>MG</b>	4.0V
RP107K411D	<b>MH</b>	4.1V
RP107K421D	<b>MJ</b>	4.2V
RP107K121D5	<b>MK</b>	1.25V
RP107K181D5	<b>ML</b>	1.85V
RP107K281D5	<b>MM</b>	2.85V

● **Power Dissipation (SC-88A)**

Power Dissipation ( $P_D$ ) depends on conditions of mounting on board. This specification is based on the Measurement Conditions below.

Measurement Conditions

	Standard Land Pattern
Environment	Mounting on Board (Wind Velocity=0m/s)
Board Material	Glass Cloth Epoxy Plastic (Double-sided)
Board Dimensions	40mm x 40mm x 1.6mm
Copper Ratio	Topside: Approx. 50%, Backside: Approx. 50%
Through-hole	$\phi 0.5\text{mm} \times 44\text{pcs}$

Measurement Result

( $T_a=25^\circ\text{C}$ ,  $T_{j\text{max}}=125^\circ\text{C}$ )

	Standard Land Pattern	Free Air
Power Dissipation	380mW	150mW
Thermal Resistance	$\theta_{ja}=(125-25^\circ\text{C})/0.38\text{W}=263^\circ\text{C/W}$	$\theta_{ja}=(125-25^\circ\text{C})/0.15\text{W}=667^\circ\text{C/W}$
	$\theta_{jc}=75^\circ\text{C/W}$	-

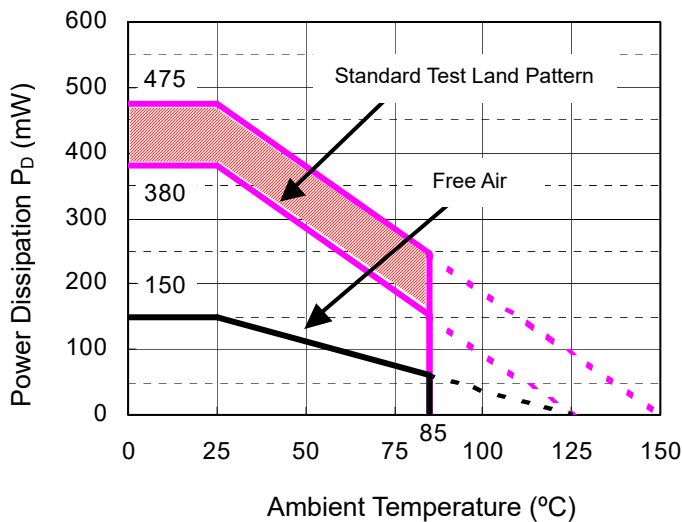

**Power Dissipation**

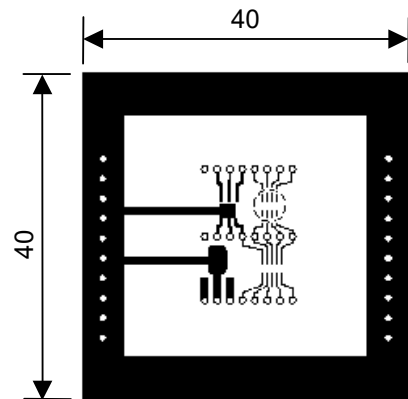

**Measurement Board Pattern**

○ IC Mount Area (Unit: mm)

The above graph shows the Power Dissipation of the SC-88A package based on  $T_{j\text{max}}=125^\circ\text{C}$  and  $T_{j\text{max}}=150^\circ\text{C}$ . Operating the ICs within the shaded area in the graph might have an influence on the lifetime of the ICs. Operating time must be within the time limit described in the table below.

Operating Time	Estimated Years (Operating 4 hrs/ day)
13,000 Hours	9 Years

\*RP107N (SOT-23-5) is the non-promotion product as of April 2017.

**RP107x**

NO.EA-181-170424

● **Package Dimensions (SC-88A)**

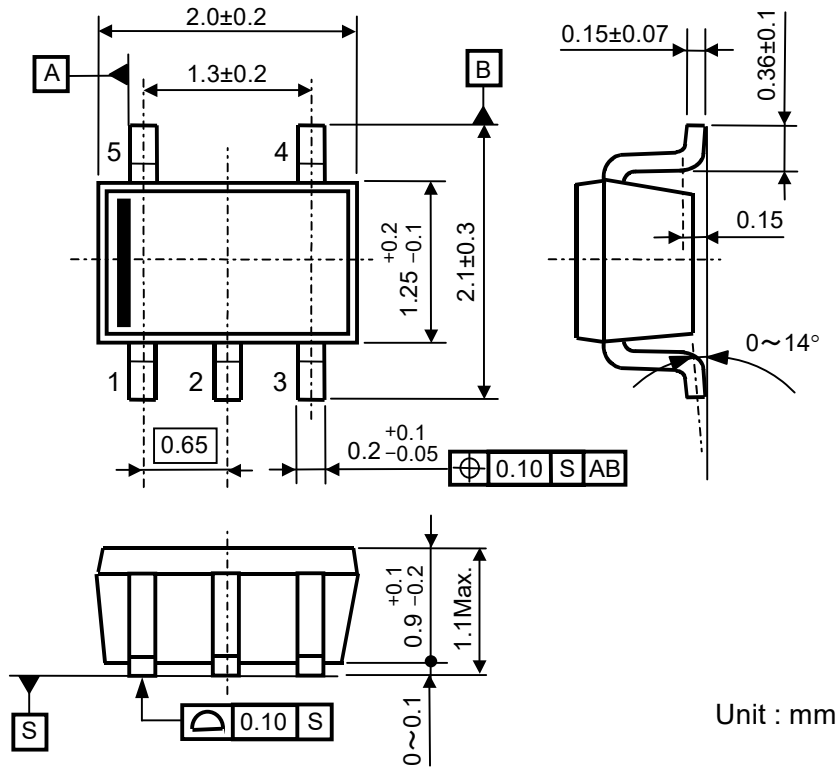

Unit : mm

● **Mark Specification (SC-88A)**

①②③④: Product Code ... **Refer to RP107Q Series Mark Specification Table.**

⑤⑥: Lot Number ... Alphanumeric Serial Number

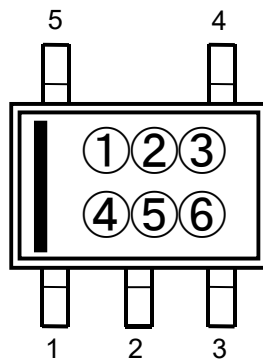



\*RP107N (SOT-23-5) is the non-promotion product as of April 2017.

**RP107x**

NO.EA-181-170424

● **RP107Q Series Mark Specification Table (SC-88A)**

<b>RP107QxxxB</b>			<b>RP107QxxxD</b>		
<b>Product Name</b>	<b>①②③④</b>	<b>V<sub>SET</sub></b>	<b>Product Name</b>	<b>①②③④</b>	<b>V<sub>SET</sub></b>
RP107Q101B	<b>N 0 1 0</b>	1.0V	RP107Q101D	<b>P 0 1 0</b>	1.0V
RP107Q111B	<b>N 0 1 1</b>	1.1V	RP107Q111D	<b>P 0 1 1</b>	1.1V
RP107Q121B	<b>N 0 1 2</b>	1.2V	RP107Q121D	<b>P 0 1 2</b>	1.2V
RP107Q131B	<b>N 0 1 3</b>	1.3V	RP107Q131D	<b>P 0 1 3</b>	1.3V
RP107Q141B	<b>N 0 1 4</b>	1.4V	RP107Q141D	<b>P 0 1 4</b>	1.4V
RP107Q151B	<b>N 0 1 5</b>	1.5V	RP107Q151D	<b>P 0 1 5</b>	1.5V
RP107Q161B	<b>N 0 1 6</b>	1.6V	RP107Q161D	<b>P 0 1 6</b>	1.6V
RP107Q171B	<b>N 0 1 7</b>	1.7V	RP107Q171D	<b>P 0 1 7</b>	1.7V
RP107Q181B	<b>N 0 1 8</b>	1.8V	RP107Q181D	<b>P 0 1 8</b>	1.8V
RP107Q191B	<b>N 0 1 9</b>	1.9V	RP107Q191D	<b>P 0 1 9</b>	1.9V
RP107Q201B	<b>N 0 2 0</b>	2.0V	RP107Q201D	<b>P 0 2 0</b>	2.0V
RP107Q211B	<b>N 0 2 1</b>	2.1V	RP107Q211D	<b>P 0 2 1</b>	2.1V
RP107Q221B	<b>N 0 2 2</b>	2.2V	RP107Q221D	<b>P 0 2 2</b>	2.2V
RP107Q231B	<b>N 0 2 3</b>	2.3V	RP107Q231D	<b>P 0 2 3</b>	2.3V
RP107Q241B	<b>N 0 2 4</b>	2.4V	RP107Q241D	<b>P 0 2 4</b>	2.4V
RP107Q251B	<b>N 0 2 5</b>	2.5V	RP107Q251D	<b>P 0 2 5</b>	2.5V
RP107Q261B	<b>N 0 2 6</b>	2.6V	RP107Q261D	<b>P 0 2 6</b>	2.6V
RP107Q271B	<b>N 0 2 7</b>	2.7V	RP107Q271D	<b>P 0 2 7</b>	2.7V
RP107Q281B	<b>N 0 2 8</b>	2.8V	RP107Q281D	<b>P 0 2 8</b>	2.8V
RP107Q291B	<b>N 0 2 9</b>	2.9V	RP107Q291D	<b>P 0 2 9</b>	2.9V
RP107Q301B	<b>N 0 3 0</b>	3.0V	RP107Q301D	<b>P 0 3 0</b>	3.0V
RP107Q311B	<b>N 0 3 1</b>	3.1V	RP107Q311D	<b>P 0 3 1</b>	3.1V
RP107Q321B	<b>N 0 3 2</b>	3.2V	RP107Q321D	<b>P 0 3 2</b>	3.2V
RP107Q331B	<b>N 0 3 3</b>	3.3V	RP107Q331D	<b>P 0 3 3</b>	3.3V
RP107Q341B	<b>N 0 3 4</b>	3.4V	RP107Q341D	<b>P 0 3 4</b>	3.4V
RP107Q351B	<b>N 0 3 5</b>	3.5V	RP107Q351D	<b>P 0 3 5</b>	3.5V
RP107Q361B	<b>N 0 3 6</b>	3.6V	RP107Q361D	<b>P 0 3 6</b>	3.6V
RP107Q371B	<b>N 0 3 7</b>	3.7V	RP107Q371D	<b>P 0 3 7</b>	3.7V
RP107Q381B	<b>N 0 3 8</b>	3.8V	RP107Q381D	<b>P 0 3 8</b>	3.8V
RP107Q391B	<b>N 0 3 9</b>	3.9V	RP107Q391D	<b>P 0 3 9</b>	3.9V
RP107Q401B	<b>N 0 4 0</b>	4.0V	RP107Q401D	<b>P 0 4 0</b>	4.0V
RP107Q411B	<b>N 0 4 1</b>	4.1V	RP107Q411D	<b>P 0 4 1</b>	4.1V
RP107Q421B	<b>N 0 4 2</b>	4.2V	RP107Q421D	<b>P 0 4 2</b>	4.2V
RP107Q121B5	<b>N 0 4 3</b>	1.25V	RP107Q121D5	<b>P 0 4 3</b>	1.25V
RP107Q181B5	<b>N 0 4 4</b>	1.85V	RP107Q181D5	<b>P 0 4 4</b>	1.85V
RP107Q281B5	<b>N 0 4 5</b>	2.85V	RP107Q281D5	<b>P 0 4 5</b>	2.85V

\*RP107N (SOT-23-5) is the non-promotion product as of April 2017.

**RP107x**

NO.EA-181-170424

● **Power Dissipation (SOT-23-5)**

Power Dissipation ( $P_D$ ) depends on conditions of mounting on board. This specification is based on the Measurement Conditions below. (Power Dissipation (SOT-23-5) is substitution of SOT-23-6.)

Measurement Conditions:

	<b>Standard Land Pattern</b>
Environment	Mounting on Board (Wind Velocity=0m/s)
Board Material	Glass Cloth Epoxy Plastic (Double-sided)
Board Dimensions	40mm x 40mm x 1.6mm
Copper Ratio	Topside: Approx. 50%, Backside: Approx. 50%
Through-holes	φ 0.5mm x 44pcs

Measurement Results:

( $T_a=25^{\circ}\text{C}$ ,  $T_{j\text{max}}=125^{\circ}\text{C}$ )

	<b>Standard Land Pattern</b>	<b>Free Air</b>
Power Dissipation	420mW	250mW
Thermal Resistance	$\theta_{ja}=(125-25^{\circ}\text{C})/0.42\text{W}=238^{\circ}\text{C}/\text{W}$	400 $^{\circ}\text{C}/\text{W}$

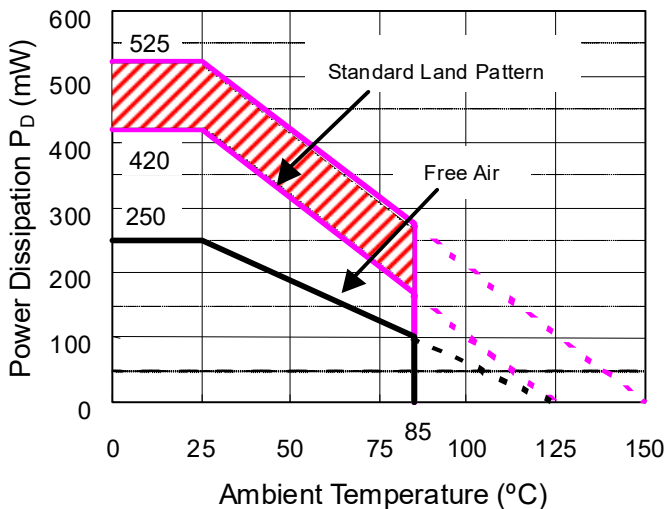

**Power Dissipation**

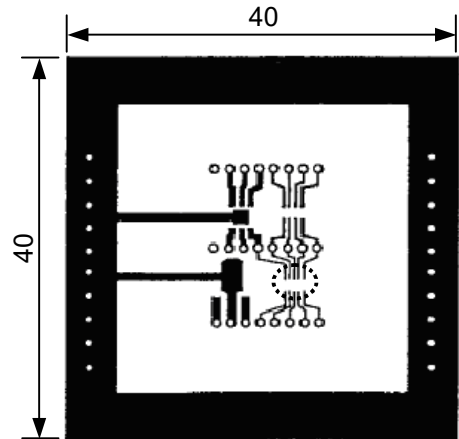

**Measurement Board Pattern**

○ IC Mount Area (Unit: mm)

The above graph shows the Power Dissipation of the SOT-23-5 package based on  $T_{j\text{max}}=125^{\circ}\text{C}$  and  $T_{j\text{max}}=150^{\circ}\text{C}$ . Operating the ICs within the shaded area in the graph might have an influence on the lifetime of the ICs. Operating time must be within the time limit described in the table below.

<b>Operating Time</b>	<b>Estimated Years (Operating 4 hrs/ day)</b>
9,000 Hours	6 Years

● Package Dimensions (SOT-23-5)

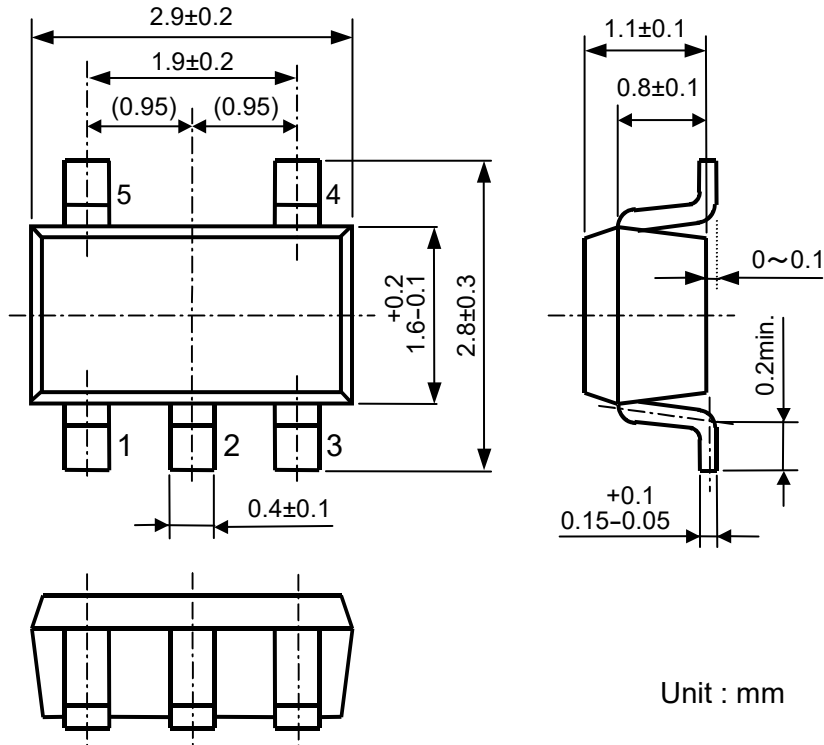

Unit : mm

● Mark Specification (SOT-23-5)

①②③: Product Code ... Refer to RP107N Series Mark Specification Table.

④⑤: Lot Number ... Alphanumeric Serial Number

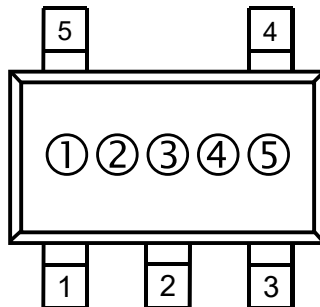

\*RP107N (SOT-23-5) is the non-promotion product as of April 2017.

## RP107x

NO.EA-181-170424

### ● RP107N Series Mark Specification Table (SOT-23-5)

RP107NxxxB			RP107NxxxD		
Product Name	①②③	V <sub>SET</sub>	Product Name	①②③	V <sub>SET</sub>
RP107N101B	AAA	1.0V	RP107N101D	ABA	1.0V
RP107N111B	AAB	1.1V	RP107N111D	ABB	1.1V
RP107N121B	AAC	1.2V	RP107N121D	ABC	1.2V
RP107N131B	AAD	1.3V	RP107N131D	ABD	1.3V
RP107N141B	AAE	1.4V	RP107N141D	ABE	1.4V
RP107N151B	AAF	1.5V	RP107N151D	ABF	1.5V
RP107N161B	AAG	1.6V	RP107N161D	ABG	1.6V
RP107N171B	AAH	1.7V	RP107N171D	ABH	1.7V
RP107N181B	AAJ	1.8V	RP107N181D	ABJ	1.8V
RP107N191B	AAK	1.9V	RP107N191D	ABK	1.9V
RP107N201B	AAL	2.0V	RP107N201D	ABL	2.0V
RP107N211B	AAM	2.1V	RP107N211D	ABM	2.1V
RP107N221B	AAN	2.2V	RP107N221D	ABN	2.2V
RP107N231B	AAP	2.3V	RP107N231D	ABP	2.3V
RP107N241B	AAQ	2.4V	RP107N241D	ABQ	2.4V
RP107N251B	AAR	2.5V	RP107N251D	ABR	2.5V
RP107N261B	AAS	2.6V	RP107N261D	ABS	2.6V
RP107N271B	AAT	2.7V	RP107N271D	ABT	2.7V
RP107N281B	AAU	2.8V	RP107N281D	ABU	2.8V
RP107N291B	AAV	2.9V	RP107N291D	ABV	2.9V
RP107N301B	AAW	3.0V	RP107N301D	ABW	3.0V
RP107N311B	AA X	3.1V	RP107N311D	AB X	3.1V
RP107N321B	AA Y	3.2V	RP107N321D	AB Y	3.2V
RP107N331B	AA Z	3.3V	RP107N331D	AB Z	3.3V
RP107N341B	BAA	3.4V	RP107N341D	BBA	3.4V
RP107N351B	BAB	3.5V	RP107N351D	BBB	3.5V
RP107N361B	BAC	3.6V	RP107N361D	BBC	3.6V
RP107N371B	BAD	3.7V	RP107N371D	BB D	3.7V
RP107N381B	BAE	3.8V	RP107N381D	BBE	3.8V
RP107N391B	BAF	3.9V	RP107N391D	BBF	3.9V
RP107N401B	BAG	4.0V	RP107N401D	BBG	4.0V
RP107N411B	BAH	4.1V	RP107N411D	BBH	4.1V
RP107N421B	BAJ	4.2V	RP107N421D	BBJ	4.2V
RP107N121B5	BAK	1.25V	RP107N121D5	BBK	1.25V
RP107N181B5	BAL	1.85V	RP107N181D5	BBL	1.85V
RP107N281B5	BAM	2.85V	RP107N281D5	BBM	2.85V

## TEST CIRCUITS

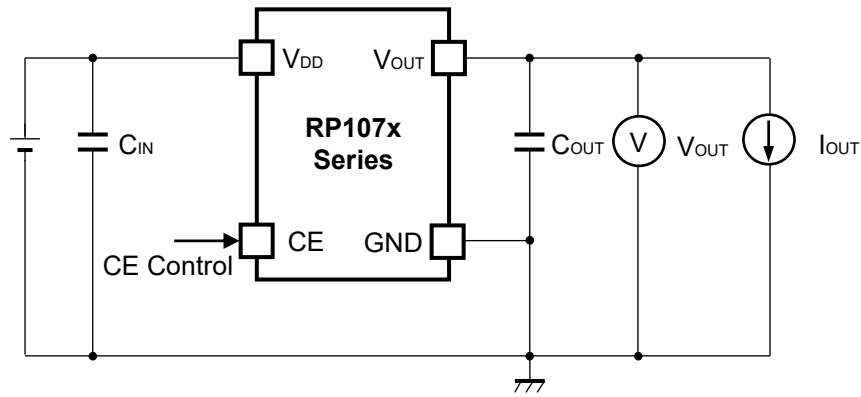

Basic Test Circuit

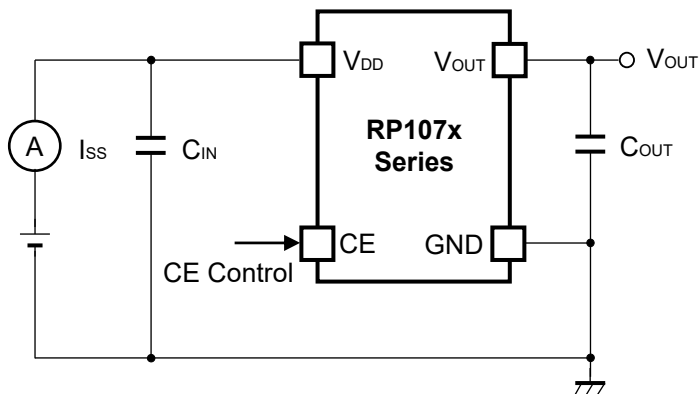

Test Circuit for Supply Current

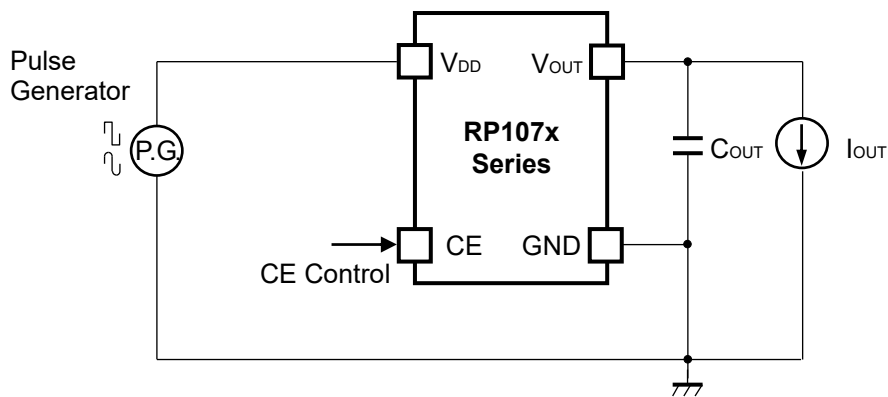

Test Circuit for Ripple Rejection

\*RP107N (SOT-23-5) is the non-promotion product as of April 2017.

---

## RP107x

NO.EA-181-170424

---

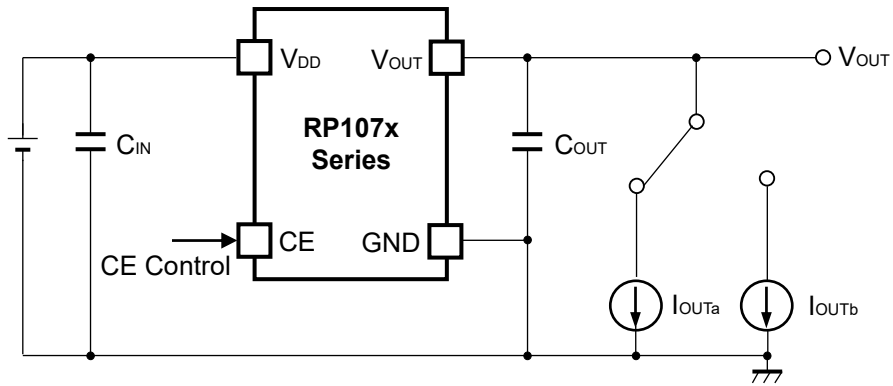

**Test Circuit for Load Transient Response**

## TYPICAL CHARACTERISTICS

### 1) Output Voltage vs. Output Current ( $C_{IN}=0.1\mu F$ , $T_{opt}=25^{\circ}C$ )

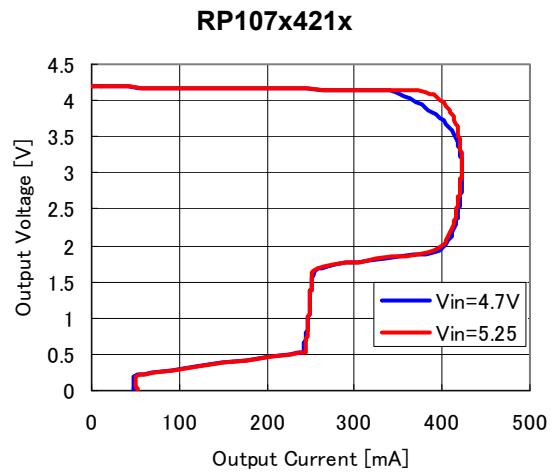
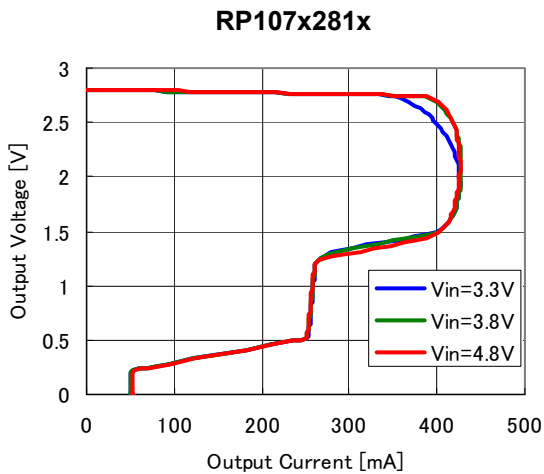
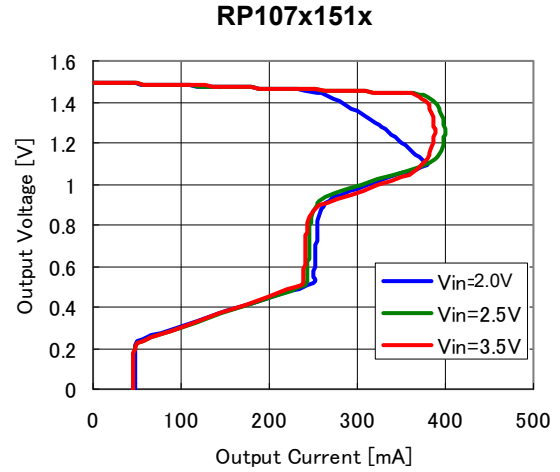
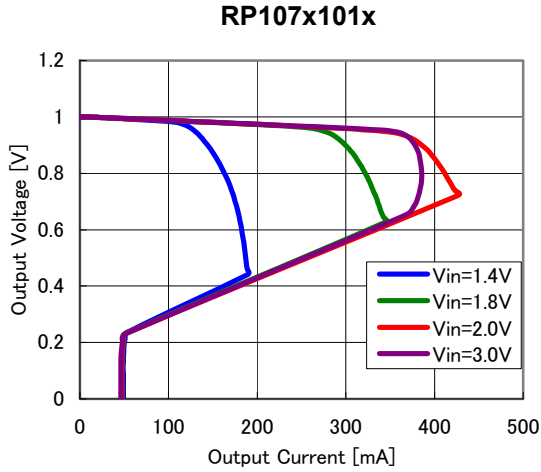

### 2) Output Voltage vs. Input Voltage ( $C_{IN}=0.1\mu F$ , $T_{opt}=25^{\circ}C$ )

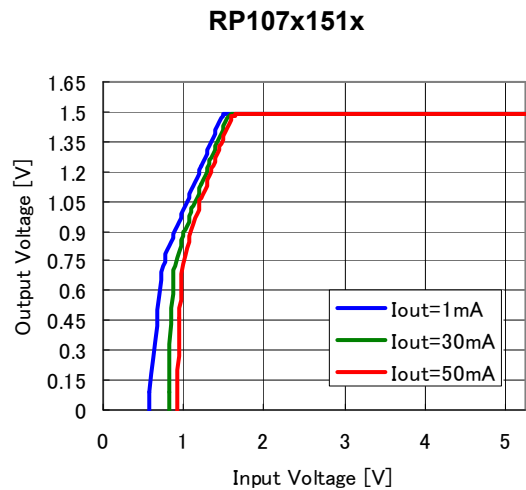
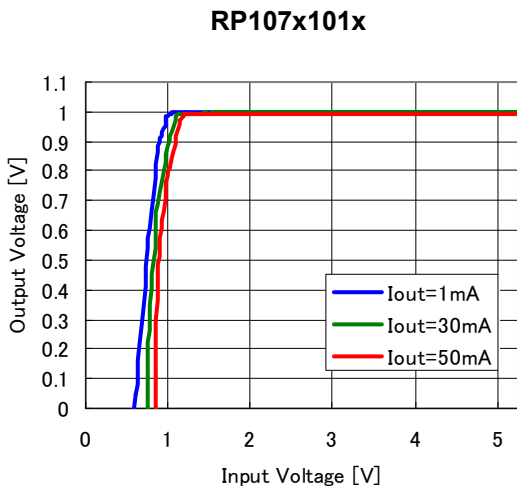

## RP107x

NO.EA-181-170424

### RP107x281x

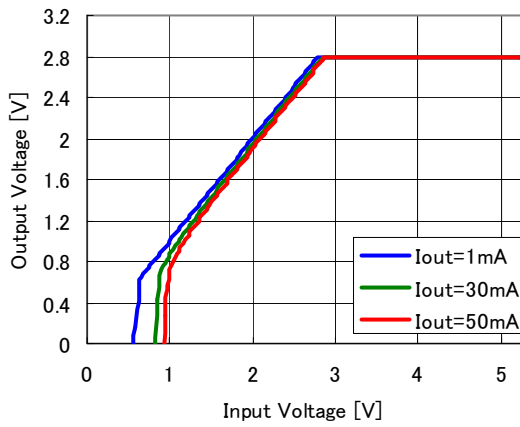

### RP107x421x

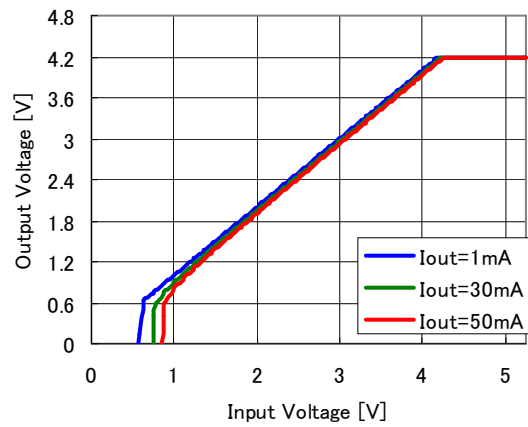

### 3) Supply Current vs. Input Voltage (C<sub>IN</sub>=0.1μF, T<sub>opt</sub>=25°C)

#### RP107x101x

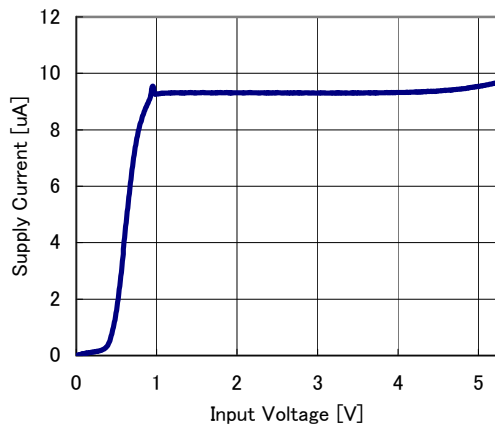

#### RP107x151x

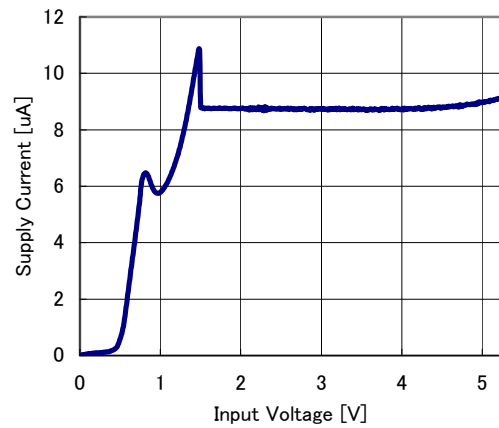

#### RP107x281x

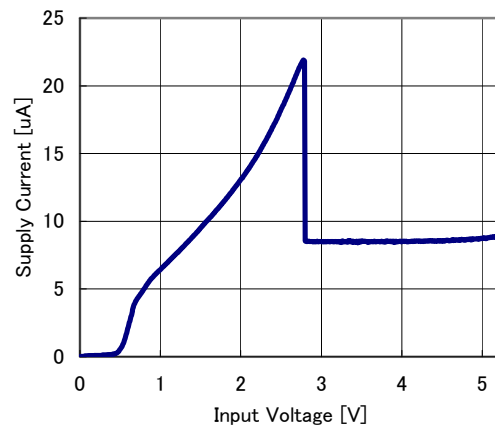

#### RP107x421x

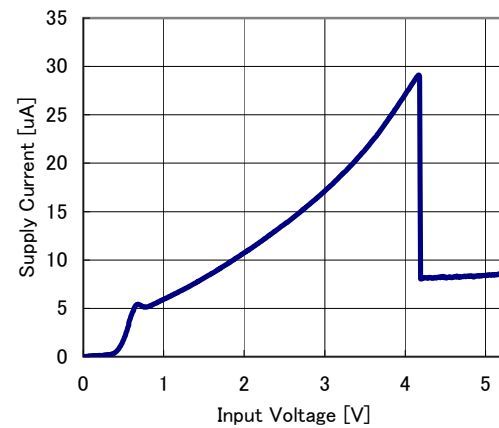



4) Output Voltage vs. Temperature ( $C_{IN}=0.1\mu F$ ,  $I_{OUT}=1mA$ )

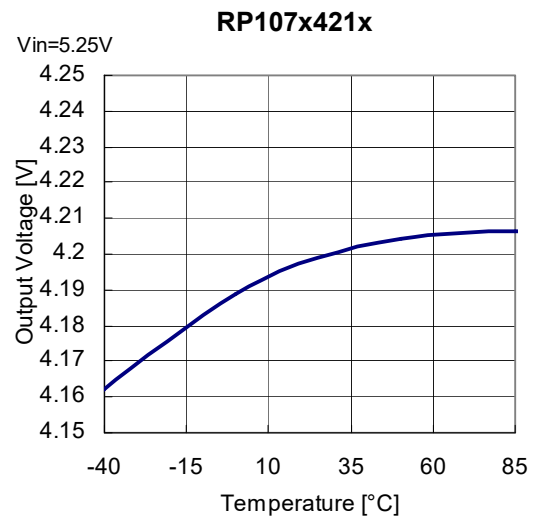
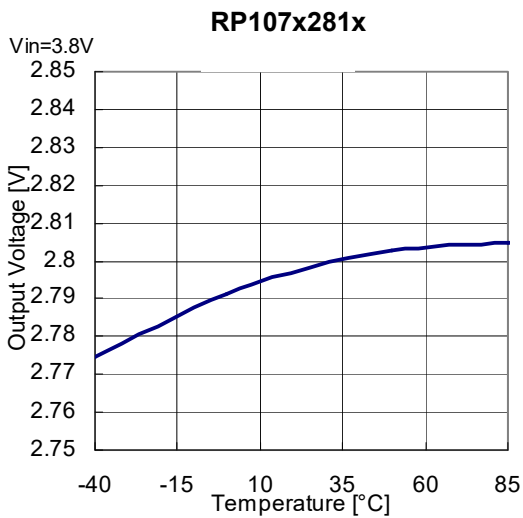
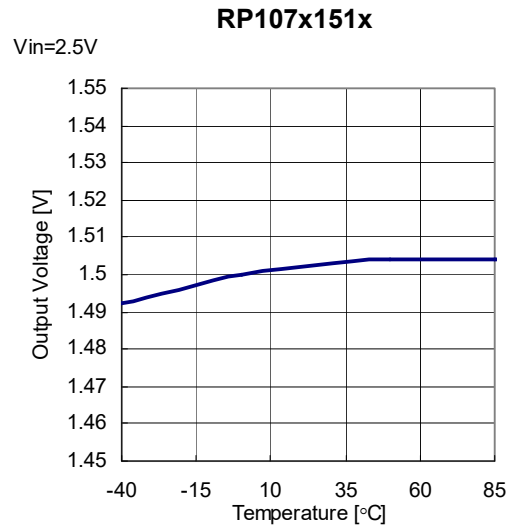
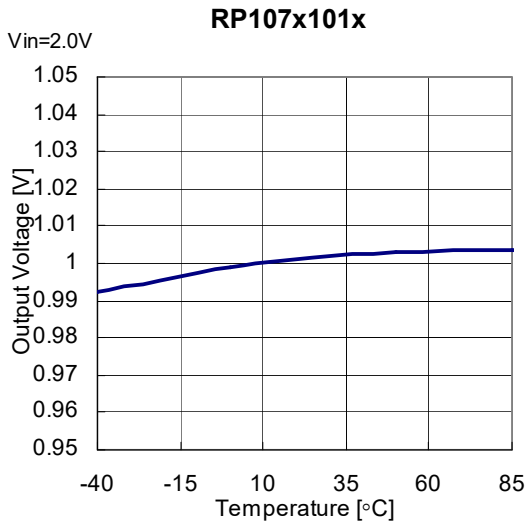

5) Supply Current vs. Temperature ( $C_{IN}=0.1\mu F$ ,  $I_{OUT}=0mA$ )

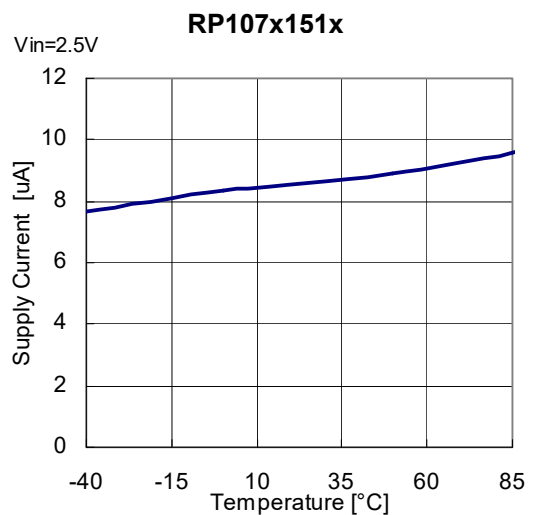
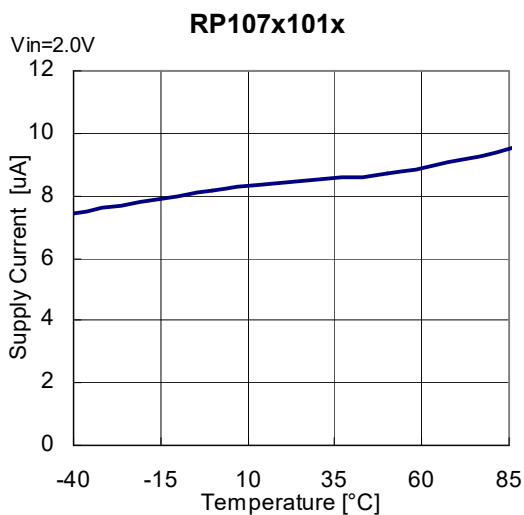

\*RP107N (SOT-23-5) is the non-promotion product as of April 2017.

## RP107x

NO.EA-181-170424

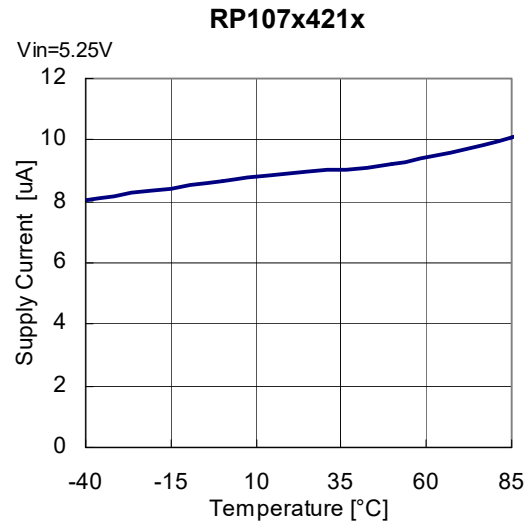
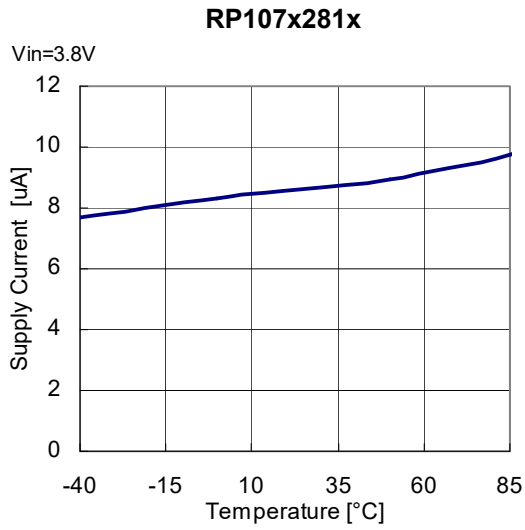

### 6) Dropout Voltage vs. Output Current (C<sub>IN</sub>=0.1μF)

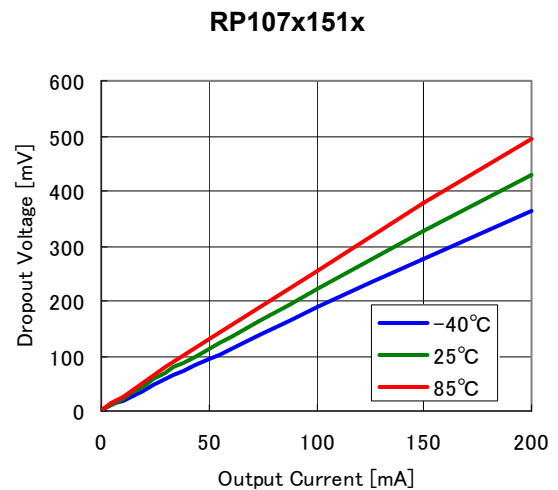
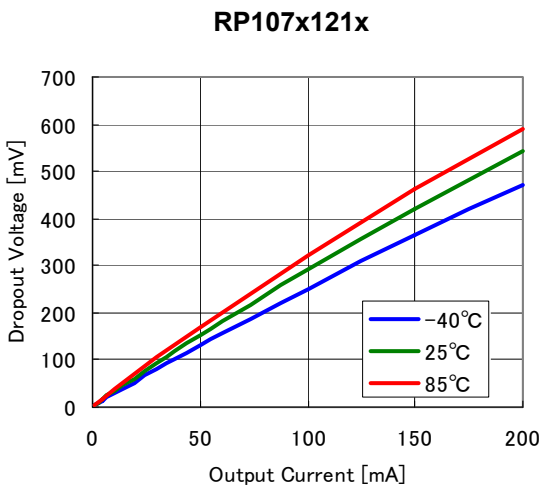
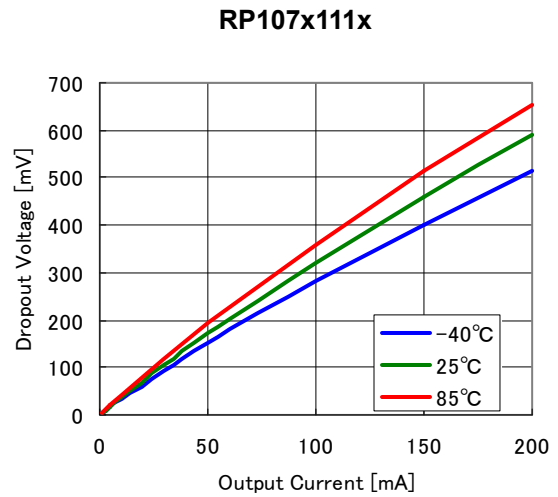
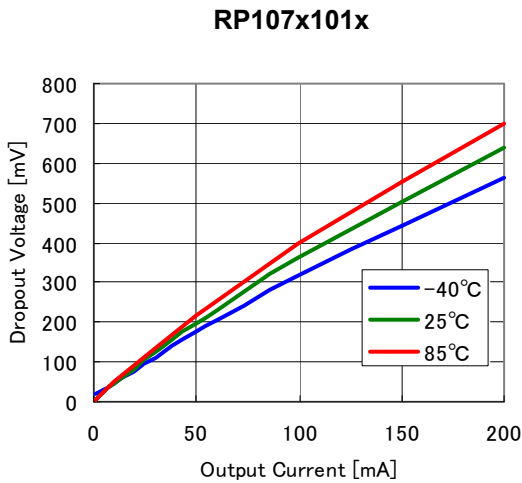

\*RP107N (SOT-23-5) is the non-promotion product as of April 2017.

**RP107x**

NO.EA-181-170424

**RP107x201x**

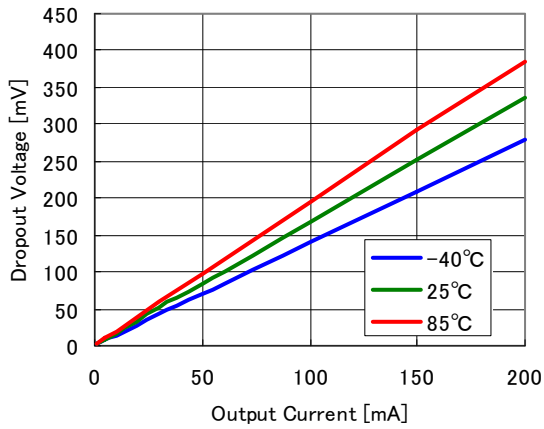

**RP107x301x**

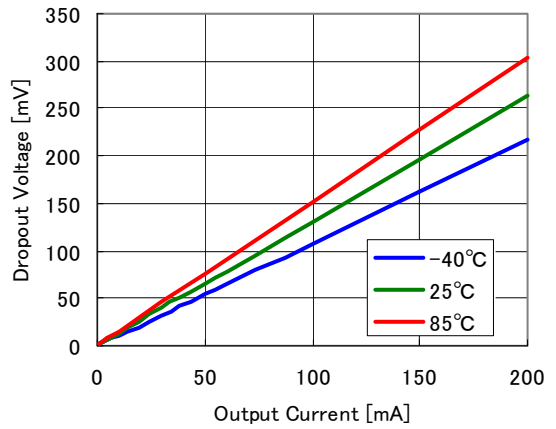

**RP107x421x**

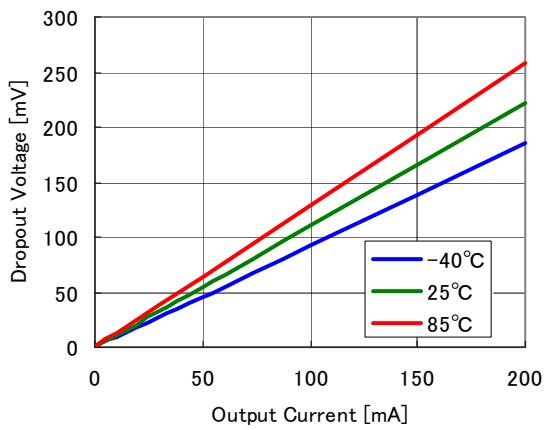

### 7) Dropout Voltage vs. Set Output Voltage ( $C_{IN}=0.1\mu F$ )

**RP107x**

$I_{out}=1mA$

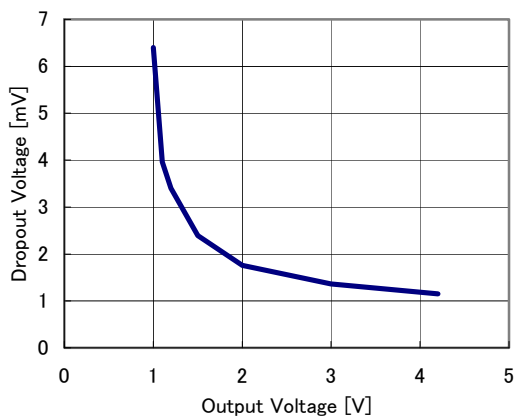

**RP107x**

$I_{out}=30mA$

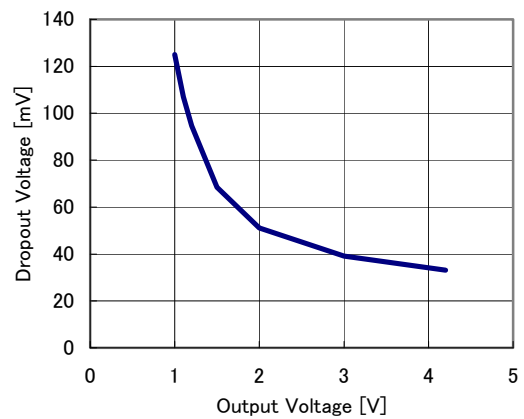

**RP107x**

NO.EA-181-170424

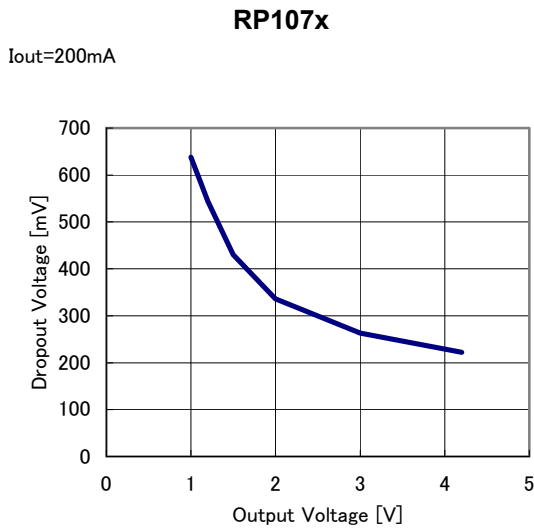
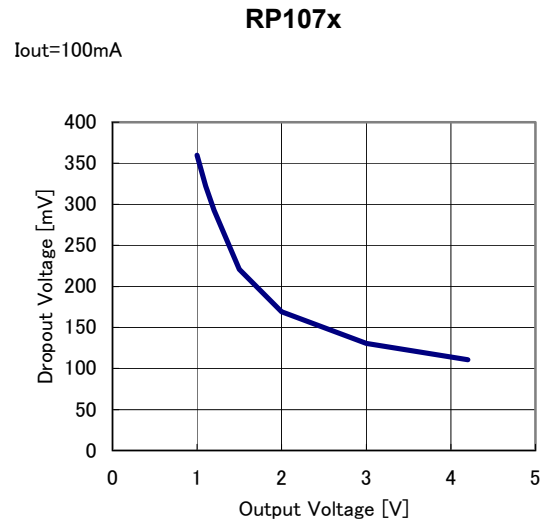
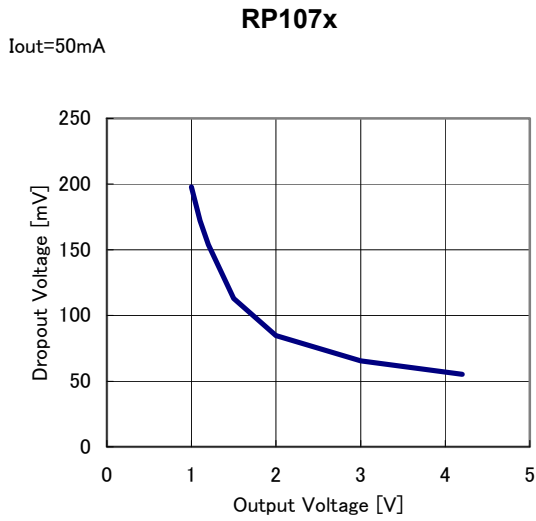

**8) Minimum Operating Voltage (C<sub>IN</sub>=0.1μF)**

**RP107x101x**

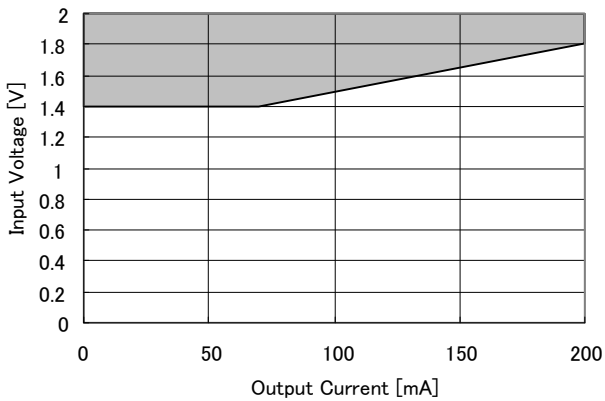

Hatched area is available for 1.0V output

**9) Ripple Rejection vs. Frequency ( $C_{IN}$ =none,  $T_{opt}$ =25°C)**

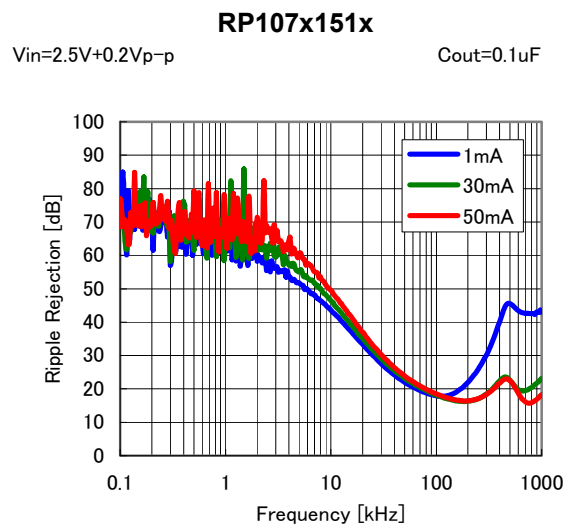
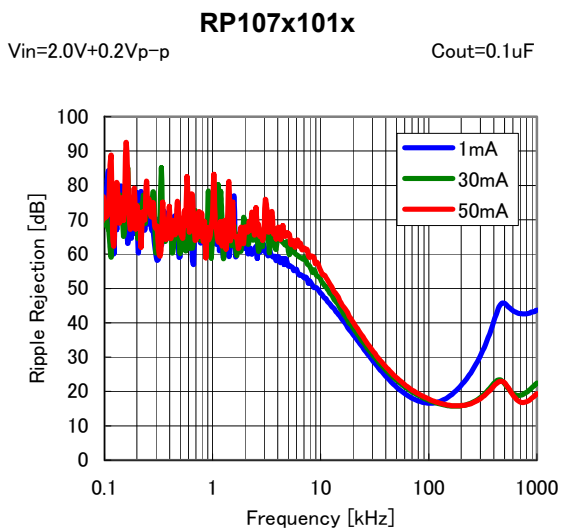
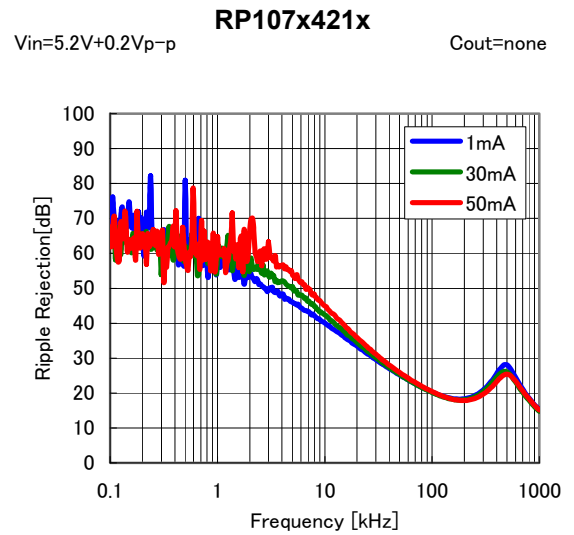
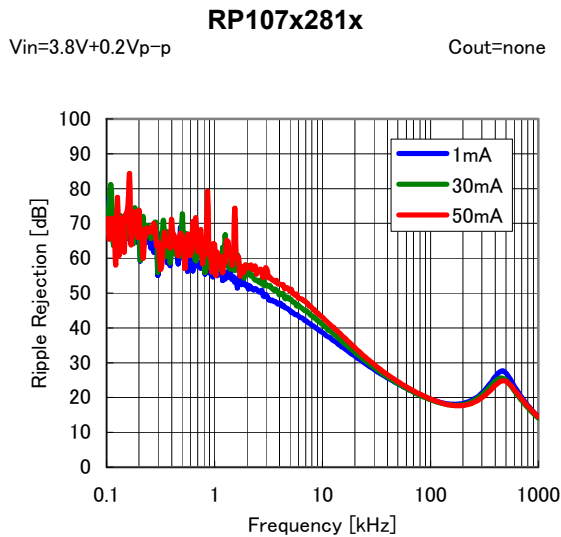
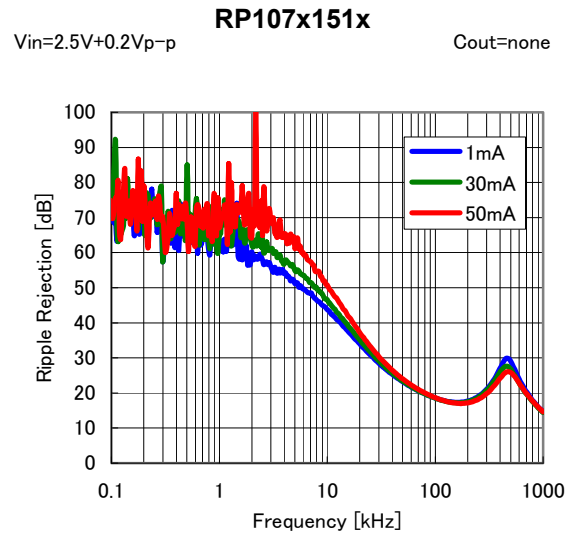
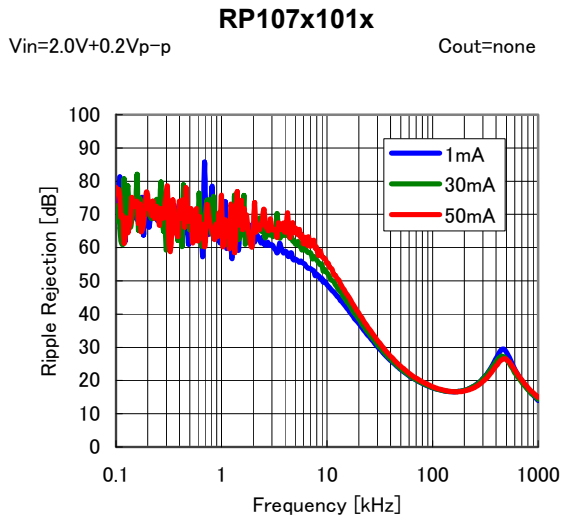

\*RP107N (SOT-23-5) is the non-promotion product as of April 2017.

## RP107x

NO.EA-181-170424

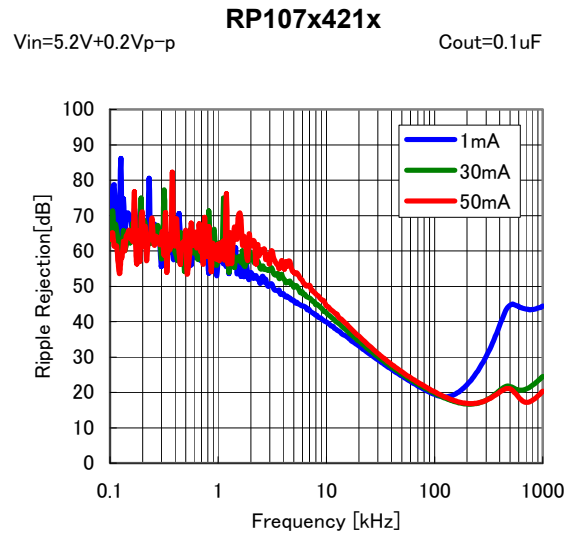
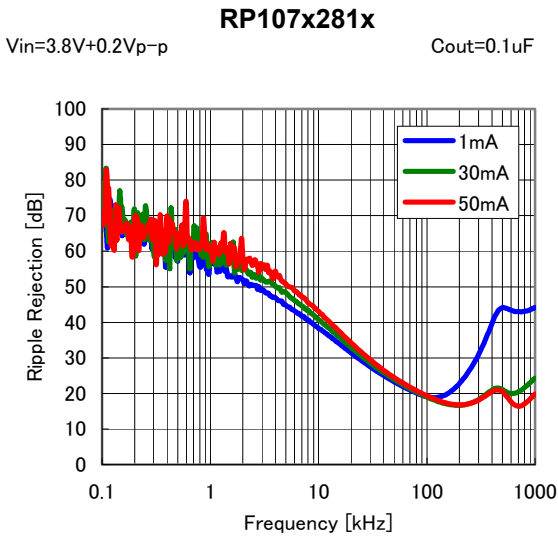

### 10) Ripple Rejection vs. Input Bias Voltage ( $C_{OUT}=0.1\mu F$ , Ripple= $0.2V_{p-p}$ , $T_{opt}=25^{\circ}C$ )

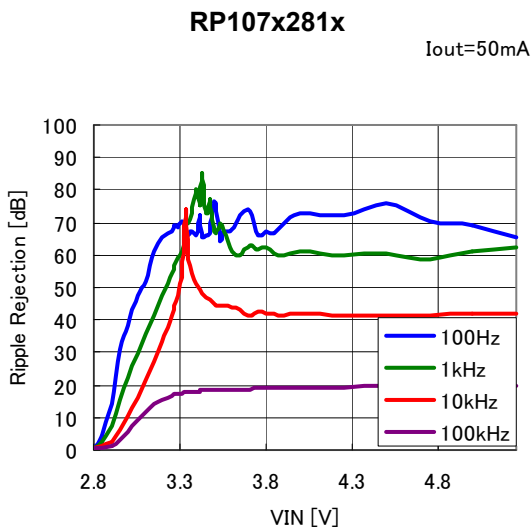
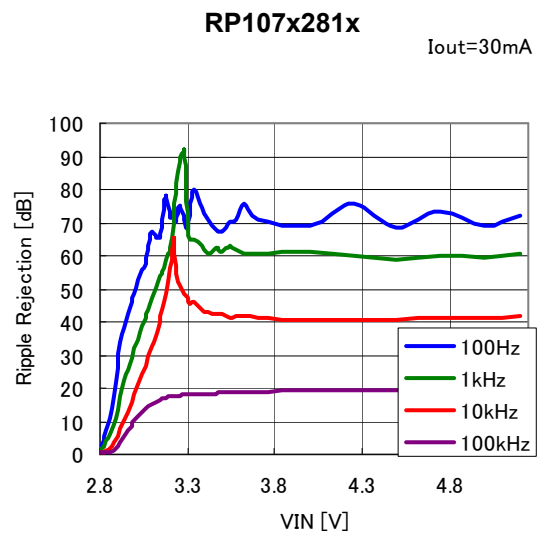
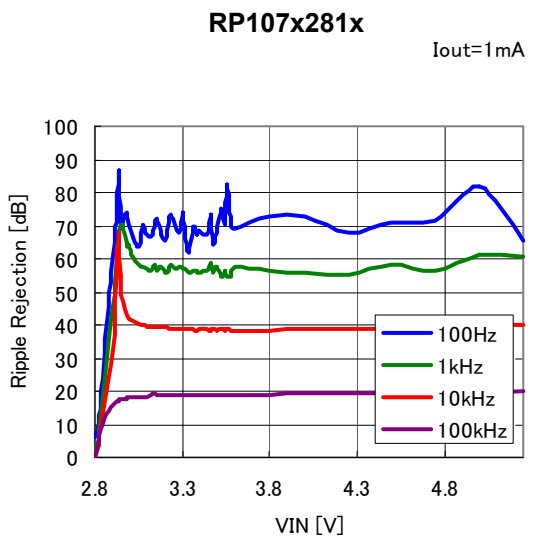

**11) Input Transient Response ( $C_{IN}$ =none,  $I_{OUT}$ =30mA,  $t_r=t_f$ =5 $\mu$ s,  $T_{opt}$ =25°C)**

**RP107x101x**

$V_{in}$ :2V $\leftrightarrow$ 3V

$C_{out}$ =none

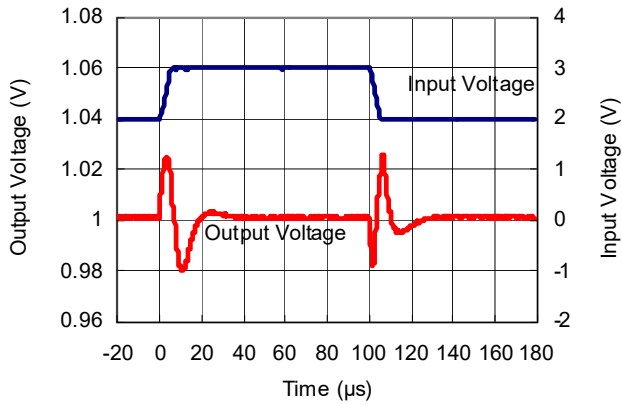

**RP107x101x**

$V_{in}$ :2V $\leftrightarrow$ 3V

$C_{out}$ =Ceramic 0.1 $\mu$ F

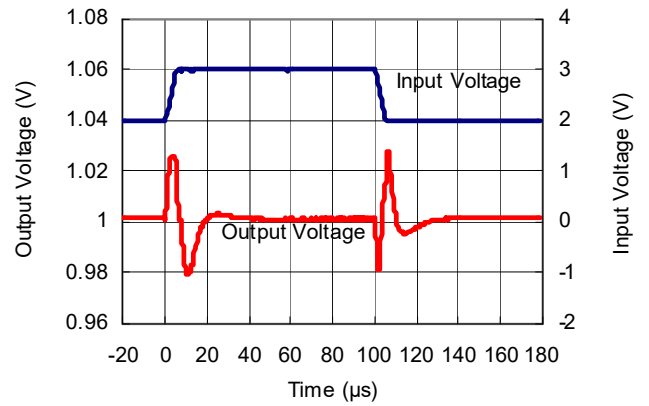

**RP107x151x**

$V_{in}$ :2.5V $\leftrightarrow$ 3.5V

$C_{out}$ =none

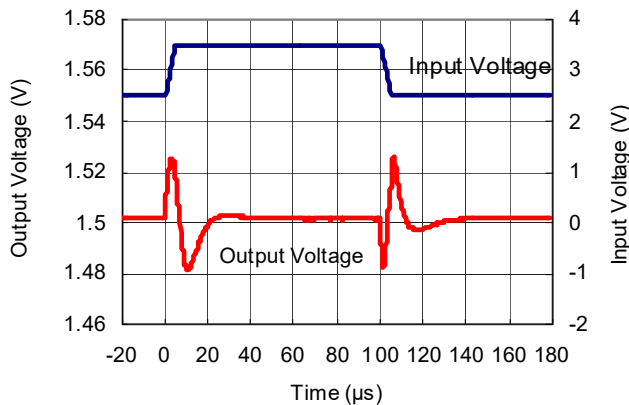

**RP107x151x**

$V_{in}$ :2.5V $\leftrightarrow$ 3.5V

$C_{out}$ =Ceramic 0.1 $\mu$ F

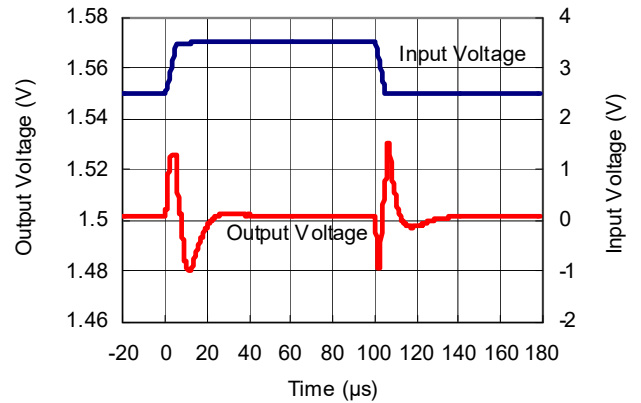

**RP107x281x**

$V_{in}$ :3.8V $\leftrightarrow$ 4.8V

$C_{out}$ =none

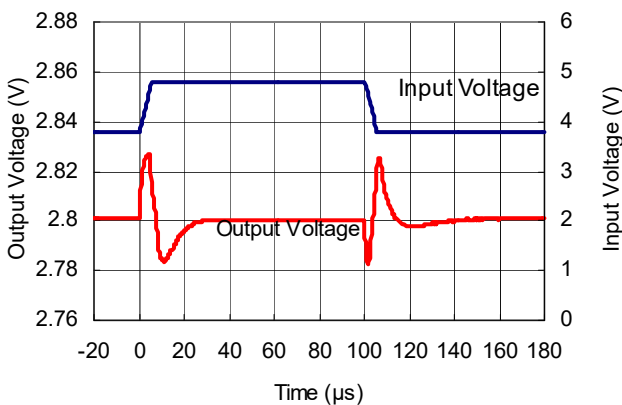

**RP107x281x**

$V_{in}$ :3.8V $\leftrightarrow$ 4.8V

$C_{out}$ =Ceramic 0.1 $\mu$ F

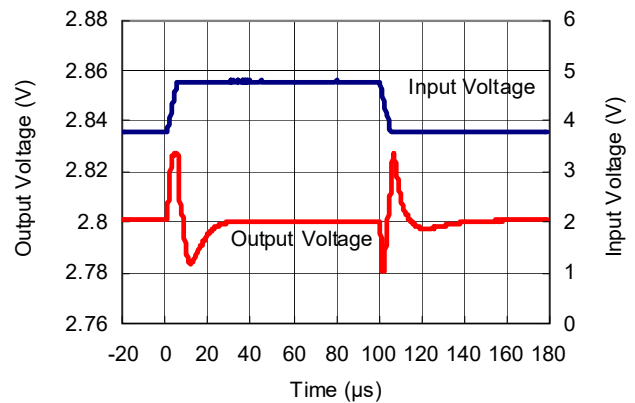

\*RP107N (SOT-23-5) is the non-promotion product as of April 2017.

## RP107x

NO.EA-181-170424

### RP107x421x

Vin: 4.5V↔5.5V

Cout=none

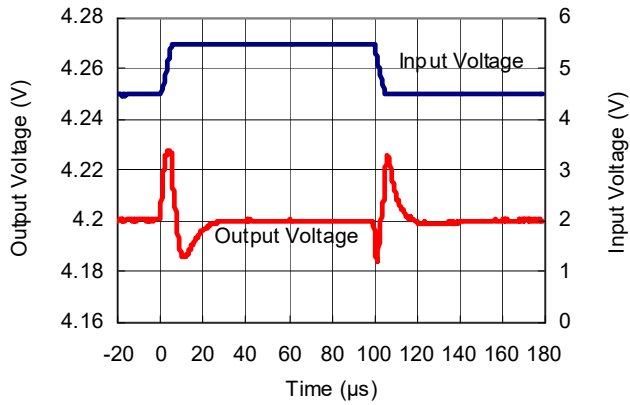

### RP107x421x

Vin: 4.5V↔5.5V

Cout=Ceramic 0.1μF

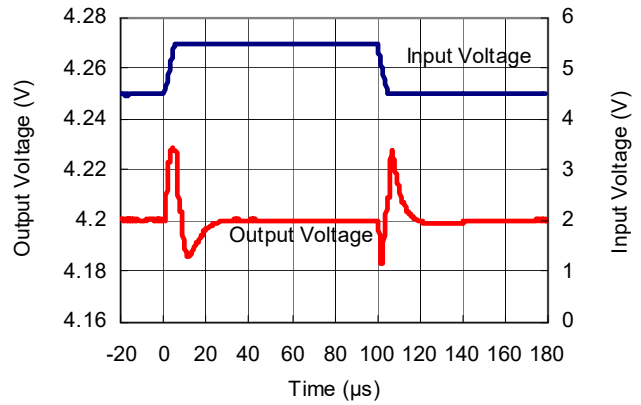

## 12) Load Transient Response (C<sub>IN</sub>=0.1μF, T<sub>opt</sub>=25°C)

### RP107x101x

Tr=Tf: 2μs  
Iout : 5mA↔50mA

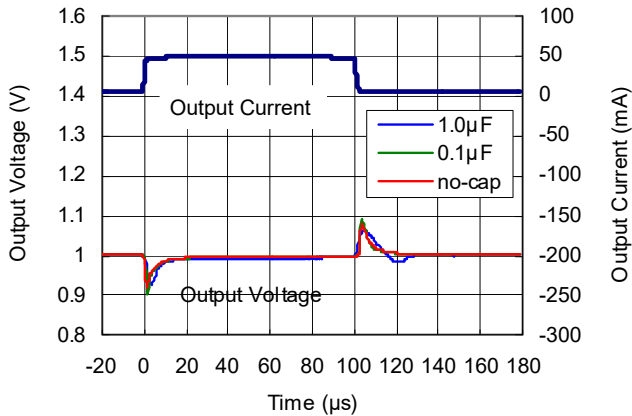

### RP107x101x

Tr=Tf: 0.5μs  
Iout : 50mA↔100mA

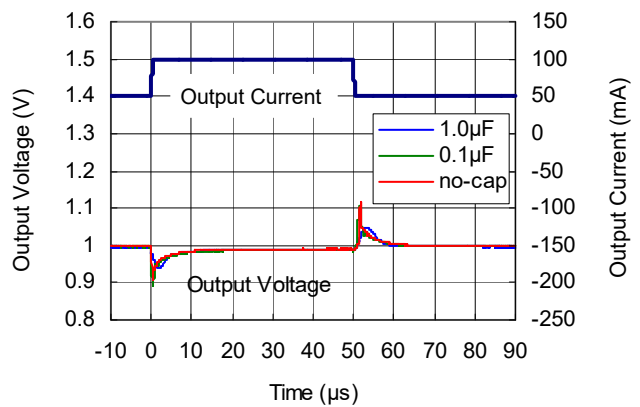

### RP107x151x

Tr=Tf: 2μs  
Iout : 5mA↔50mA

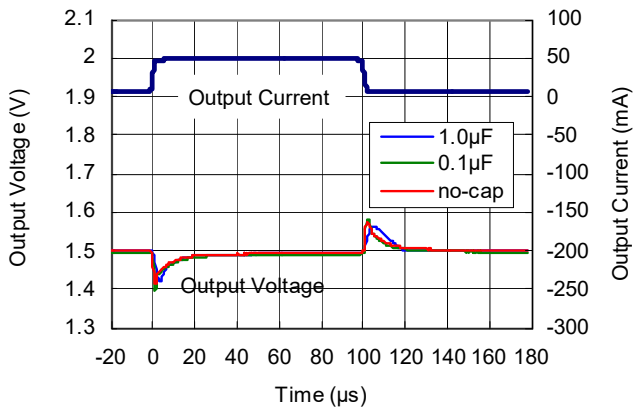

### RP107x151x

Tr=Tf: 0.5μs  
Iout : 50mA↔100mA

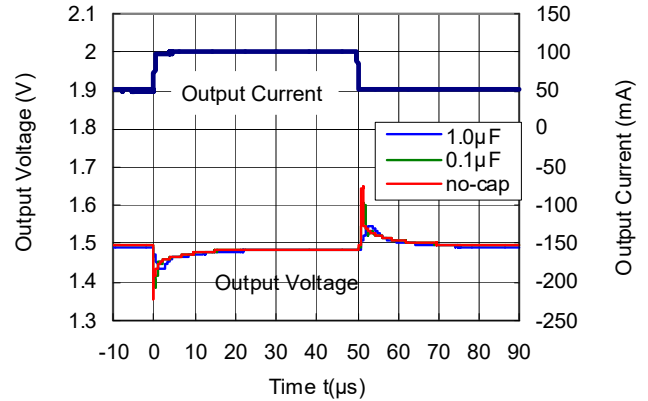



\*RP107N (SOT-23-5) is the non-promotion product as of April 2017.

**RP107x**

NO.EA-181-170424

**RP107x281x**

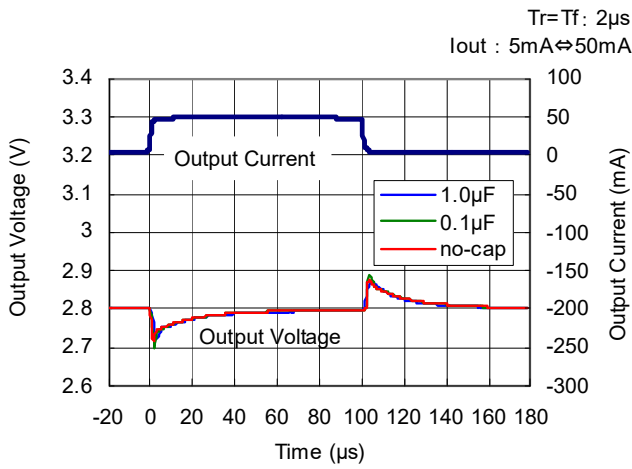

**RP107x281x**

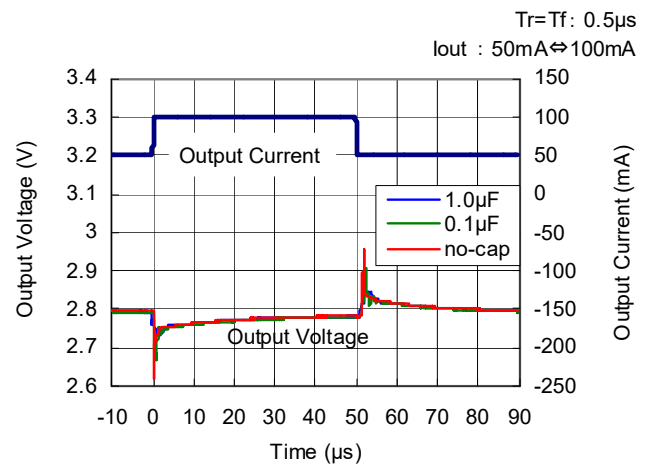

**RP107x421x**

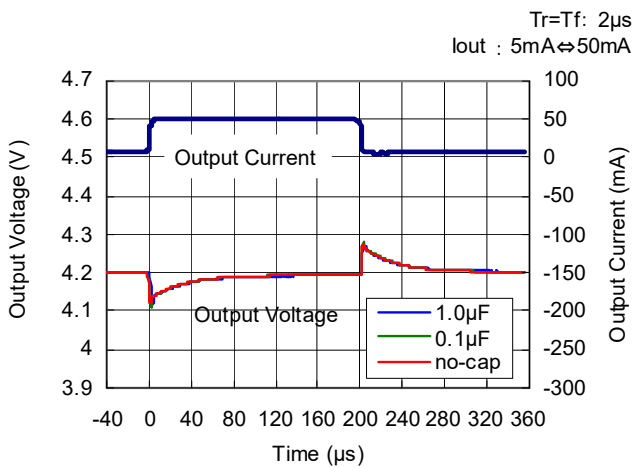

**RP107x421x**

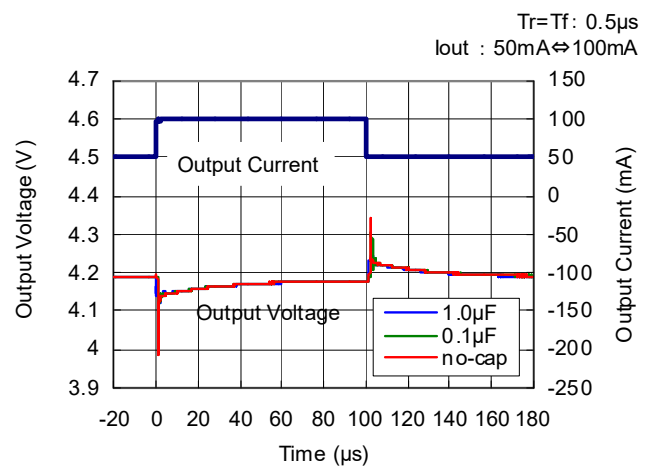

**13) Turn On Speed with CE pin (C<sub>IN</sub>=0.1µF, T<sub>opt</sub>=25°C)**

**RP107x101x**

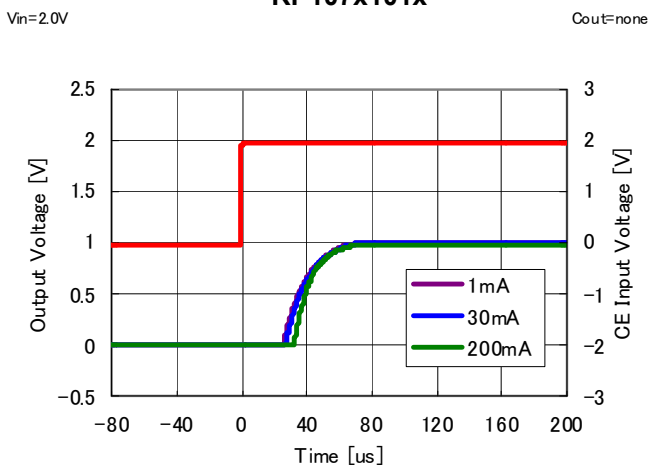

**RP107x151x**

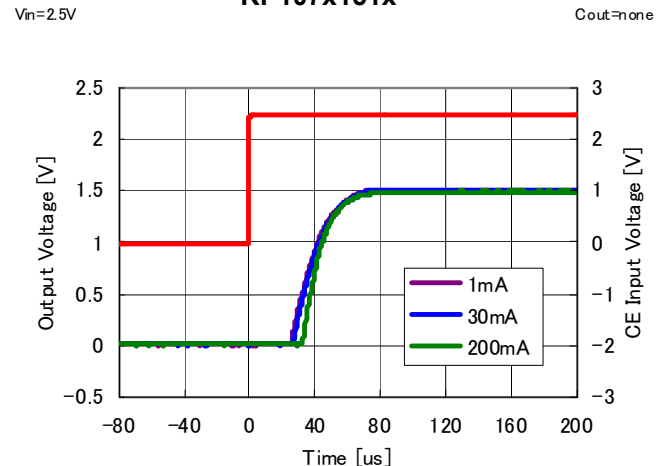

\*RP107N (SOT-23-5) is the non-promotion product as of April 2017.

## RP107x

NO.EA-181-170424

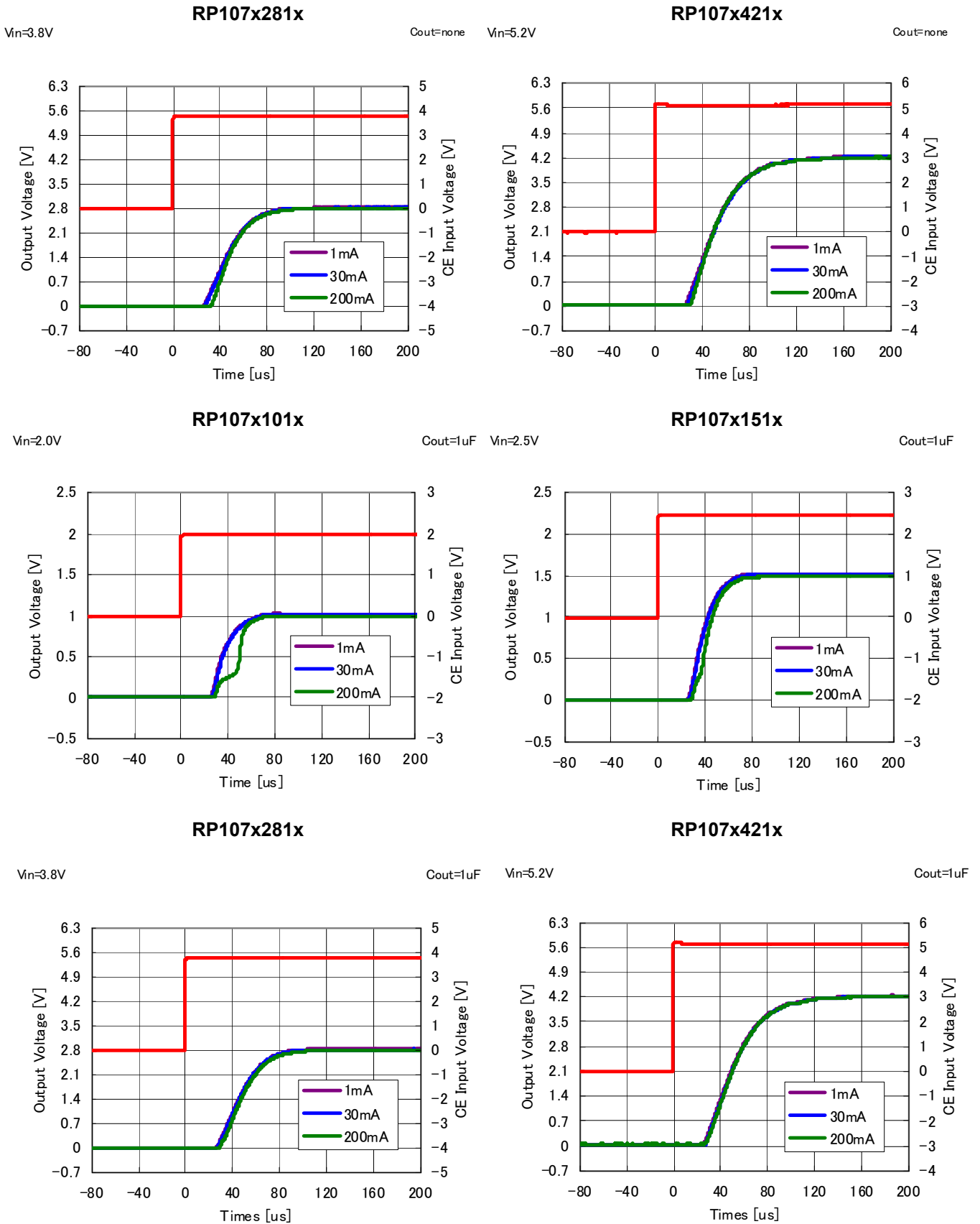

14) Turn Off Speed with CE pin (D Version) ( $C_{IN}=0.1\mu F$ ,  $T_{opt}=25^{\circ}C$ )

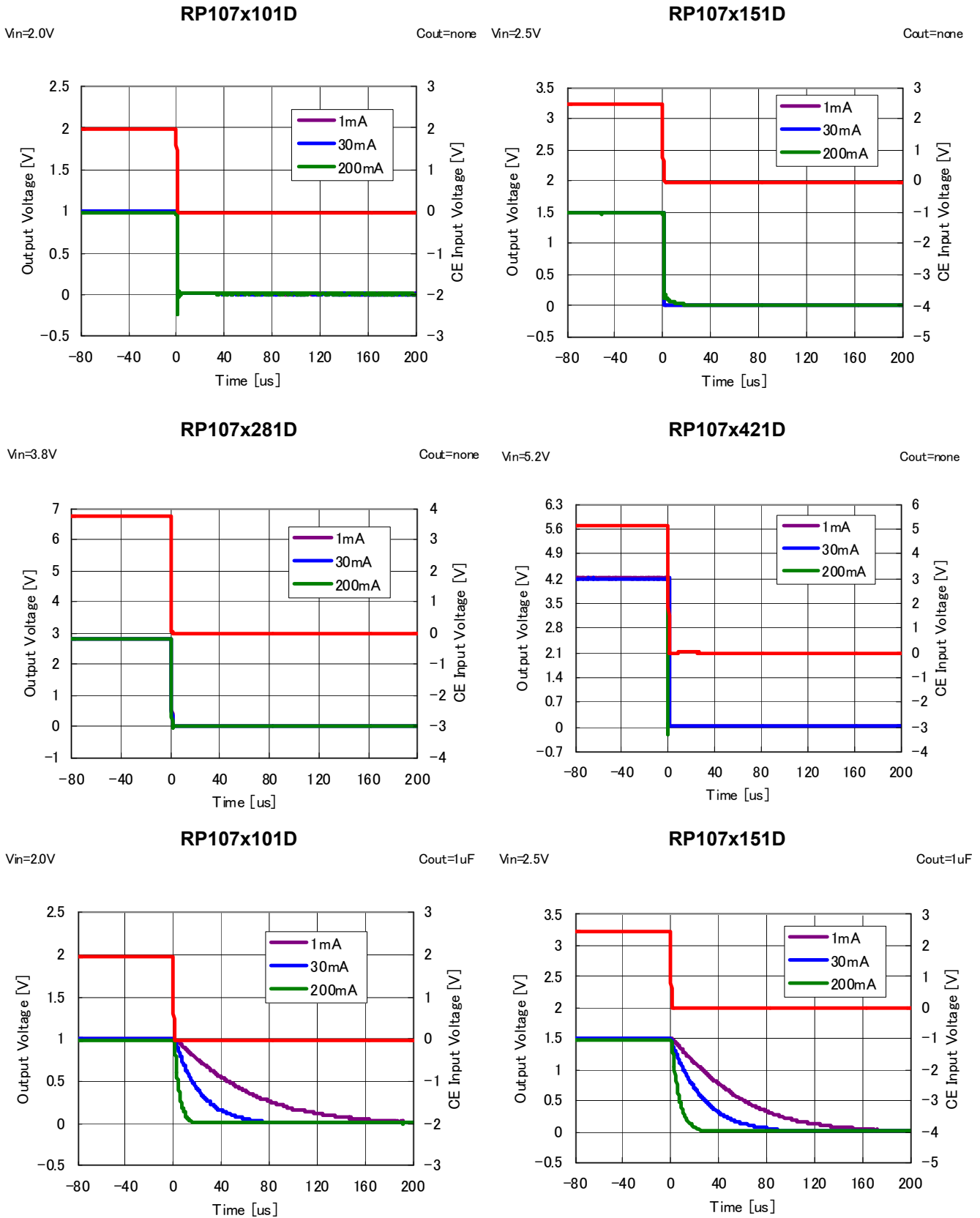

**RP107x**

NO.EA-181-170424

**RP107x281D**

$V_{in}=3.8V$

$C_{out}=1\mu F$

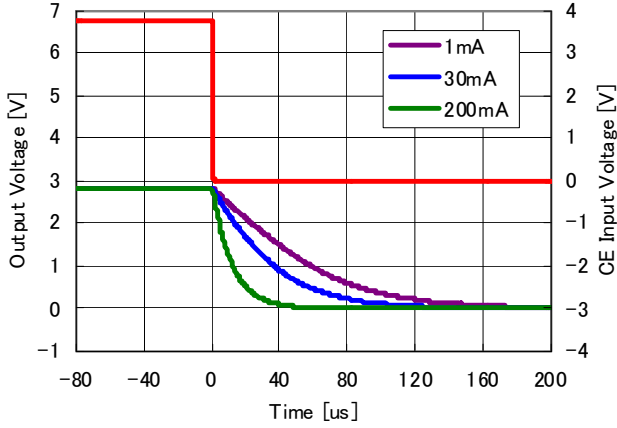

**RP107x421D**

$V_{in}=5.2V$

$C_{out}=1\mu F$

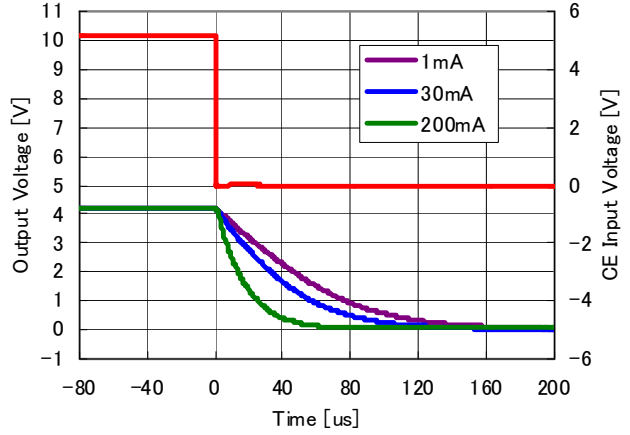

**15) Inrush Current ( $C_{IN}=0.1\mu F$ ,  $T_{opt}=25^{\circ}C$ )**

**RP107x101x**

$V_{IN}=2.0V$   
 $C_{OUT}=none$

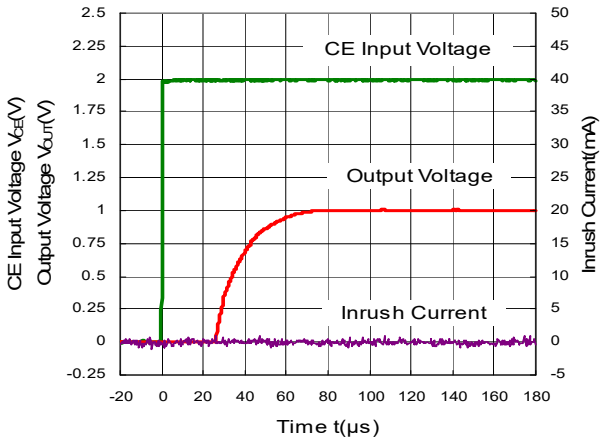

**RP107x101x**

$V_{IN}=2.0V$   
 $C_{OUT}=Ceramic1.0\mu F$

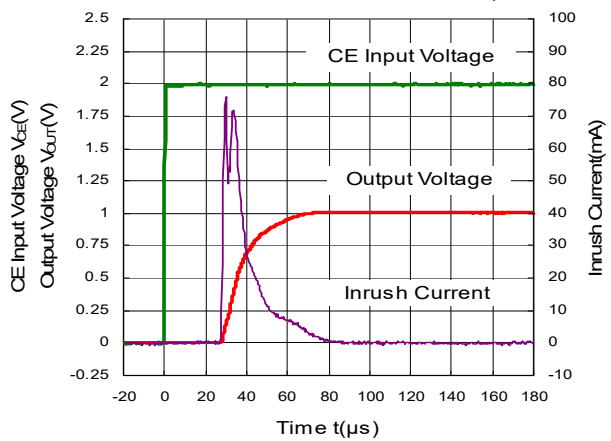

**RP107x101x**

$V_{IN}=2.0V$   
 $C_{OUT}=Ceramic4.7\mu F$

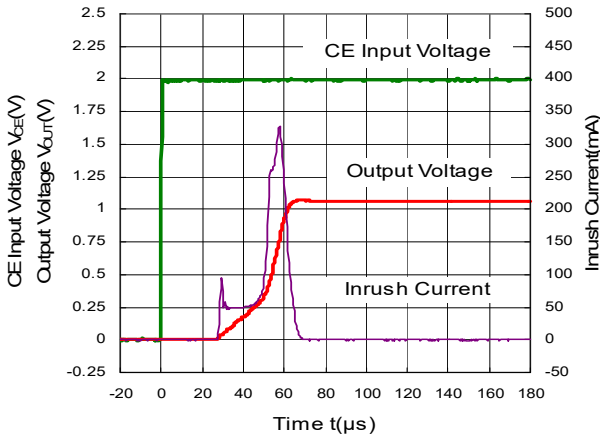

**RP107x281x**

$V_{IN}=3.8V$   
 $C_{OUT}=none$

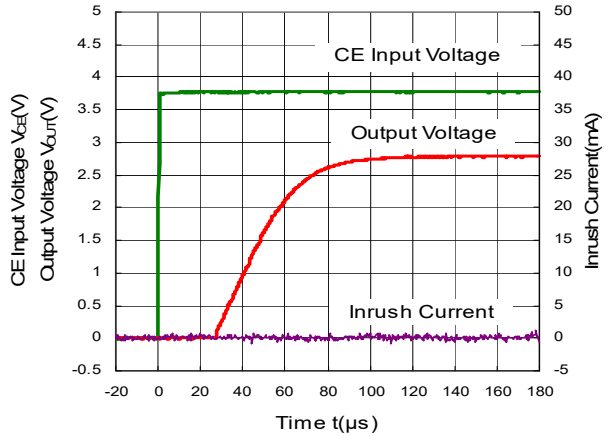

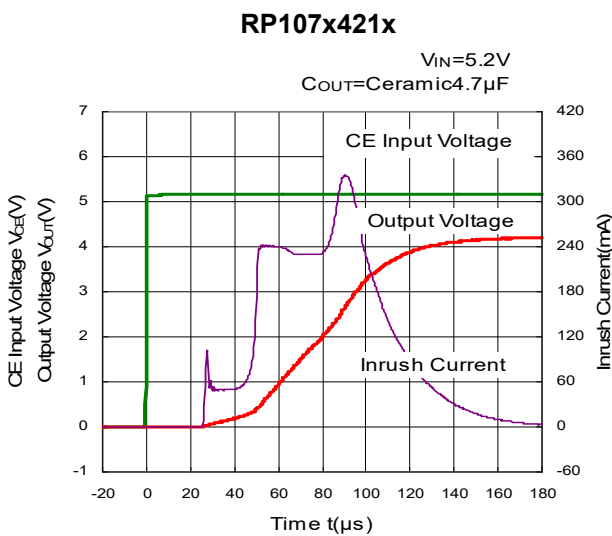
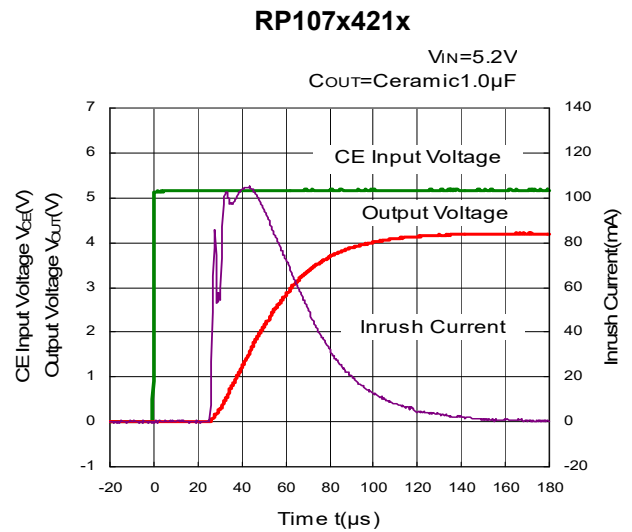
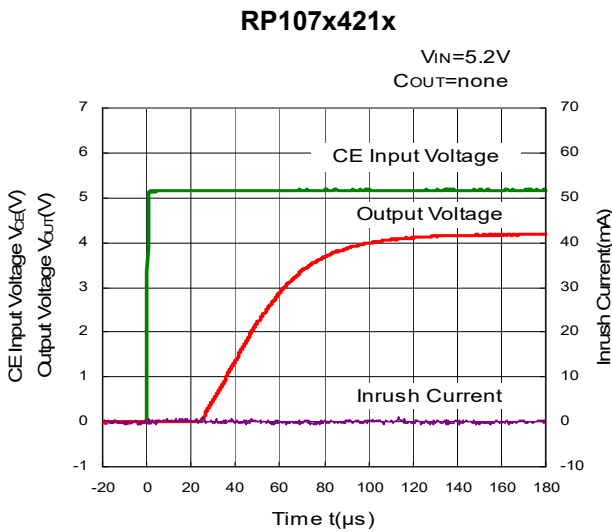
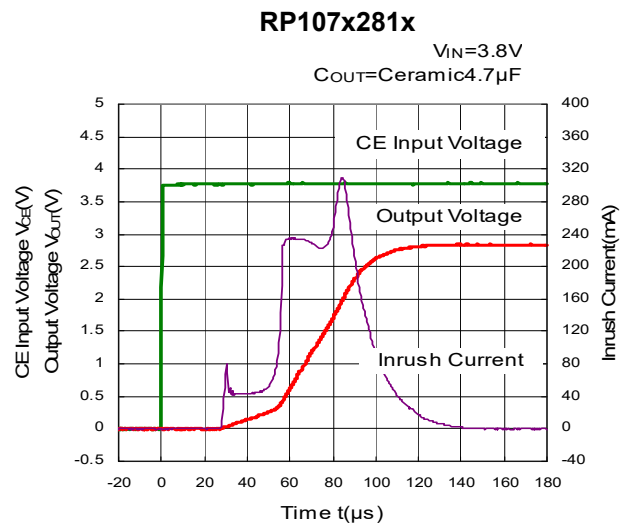
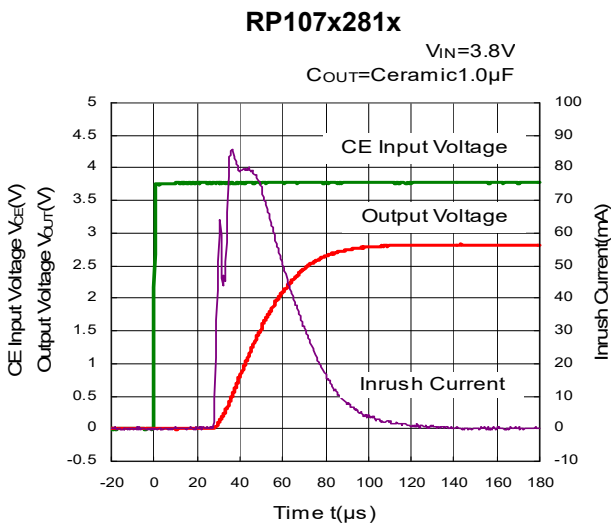

## RP107x

NO.EA-181-170424

### ESR vs. Output Current

When using these ICs, consider the following points:

The relations between  $I_{OUT}$  (Output Current) and ESR of an output capacitor are shown below.

The conditions when the white noise level is under  $40\mu\text{V}$  (Avg.) are marked as the hatched area in the graph.

#### Measurement conditions

Frequency Band : 10Hz to 2MHz

Temperature :  $-40^{\circ}\text{C}$  to  $85^{\circ}\text{C}$

$C_{IN}$ ,  $C_{OUT}$  : Ceramic  $0.1\mu\text{F}$

**RP107x101x**

$V_{in}=1.0\text{V}\sim 5.25\text{V}$

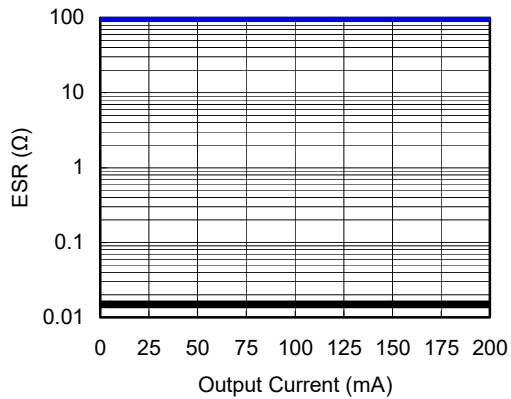

**RP107x281x**

$V_{in}=1.0\text{V}\sim 5.25\text{V}$

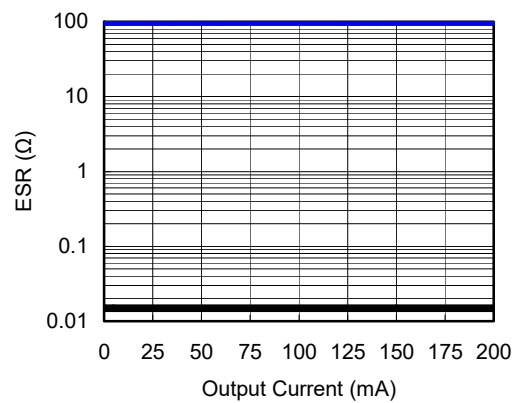

**RP107x421x**

$V_{in}=1.0\text{V}\sim 5.25\text{V}$

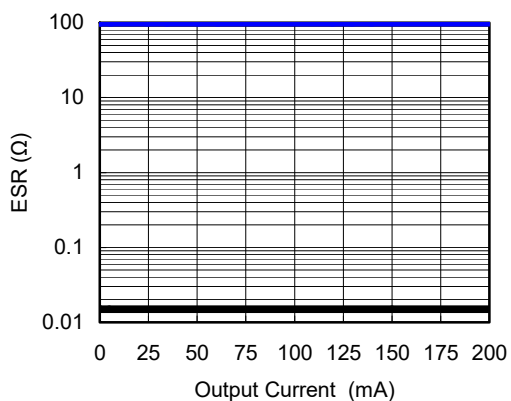



1. The products and the product specifications described in this document are subject to change or discontinuation of production without notice for reasons such as improvement. Therefore, before deciding to use the products, please refer to Ricoh sales representatives for the latest information thereon.
2. The materials in this document may not be copied or otherwise reproduced in whole or in part without prior written consent of Ricoh.
3. Please be sure to take any necessary formalities under relevant laws or regulations before exporting or otherwise taking out of your country the products or the technical information described herein.
4. The technical information described in this document shows typical characteristics of and example application circuits for the products. The release of such information is not to be construed as a warranty of or a grant of license under Ricoh's or any third party's intellectual property rights or any other rights.
5. The products listed in this document are intended and designed for use as general electronic components in standard applications (office equipment, telecommunication equipment, measuring instruments, consumer electronic products, amusement equipment etc.). Those customers intending to use a product in an application requiring extreme quality and reliability, for example, in a highly specific application where the failure or misoperation of the product could result in human injury or death (aircraft, spacevehicle, nuclear reactor control system, traffic control system, automotive and transportation equipment, combustion equipment, safety devices, life support system etc.) should first contact us.
6. We are making our continuous effort to improve the quality and reliability of our products, but semiconductor products are likely to fail with certain probability. In order to prevent any injury to persons or damages to property resulting from such failure, customers should be careful enough to incorporate safety measures in their design, such as redundancy feature, fire containment feature and fail-safe feature. We do not assume any liability or responsibility for any loss or damage arising from misuse or inappropriate use of the products.
7. Anti-radiation design is not implemented in the products described in this document.
8. The X-ray exposure can influence functions and characteristics of the products. Confirm the product functions and characteristics in the evaluation stage.
9. WLCSP products should be used in light shielded environments. The light exposure can influence functions and characteristics of the products under operation or storage.
10. There can be variation in the marking when different AOI (Automated Optical Inspection) equipment is used. In the case of recognizing the marking characteristic with AOI, please contact Ricoh sales or our distributor before attempting to use AOI.
11. Please contact Ricoh sales representatives should you have any questions or comments concerning the products or the technical information.



**Ricoh is committed to reducing the environmental loading materials in electrical devices with a view to contributing to the protection of human health and the environment.**

Ricoh has been providing RoHS compliant products since April 1, 2006 and Halogen-free products since April 1, 2012.

**RICOH** RICOH ELECTRONIC DEVICES CO., LTD.

<http://www.e-devices.ricoh.co.jp/en/>

#### Sales & Support Offices

##### **RICOH ELECTRONIC DEVICES CO., LTD.**

**Higashi-Shinagawa Office (International Sales)**  
3-32-3, Higashi-Shinagawa, Shinagawa-ku, Tokyo 140-8655, Japan  
Phone: +81-3-5479-2857 Fax: +81-3-5479-0502

##### **RICOH EUROPE (NETHERLANDS) B.V.**

**Semiconductor Support Centre**  
Prof. W.H. Keesomlaan 1, 1183 DJ Amstelveen, The Netherlands  
Phone: +31-20-5474-309

##### **RICOH INTERNATIONAL B.V. - German Branch**

**Semiconductor Sales and Support Centre**  
Oberrather Strasse 6, 40472 Düsseldorf, Germany  
Phone: +49-211-6546-0

##### **RICOH ELECTRONIC DEVICES KOREA CO., LTD.**

3F, Haesung Bldg, 504, Teheran-ro, Gangnam-gu, Seoul, 135-725, Korea  
Phone: +82-2-2135-5700 Fax: +82-2-2051-5713

##### **RICOH ELECTRONIC DEVICES SHANGHAI CO., LTD.**

Room 403, No.2 Building, No.690 Bibo Road, Pu Dong New District, Shanghai 201203, People's Republic of China  
Phone: +86-21-5027-3200 Fax: +86-21-5027-3299

##### **RICOH ELECTRONIC DEVICES CO., LTD.**

**Taipei office**  
Room 109, 10F-1, No.51, Hengyang Rd., Taipei City, Taiwan (R.O.C.)  
Phone: +886-2-2313-1621/1622 Fax: +886-2-2313-1623