

300mA 36V Input Regulator

NO.EA-300-130530

OUTLINE

The R1511x Series are CMOS-based high-voltage resistant and fast response voltage regulators that provide the minimum 300mA of output current. Internally, R1511x consists of an Output Short-circuit Protection Circuit, an Over-current Protection Circuit, and a Thermal Shutdown Circuit in addition to the basic regulator circuits. The operating temperature range is between -40°C to $+105^{\circ}\text{C}$, and the maximum input voltage is 36V. All these features allow the R1511x Series to become an ideal power source of electric home appliances.

R1511x is available in B version (R1511xxxxB) with the fixed output voltage type, and C version (R1511x001C) with adjustable output voltage type with external resistors. The output voltage accuracy is $\pm 1.0\%$.

R1511x is available in two types of packages: HSOP-6J for high-density mounting and TO-252-5-P2 for high wattage.

FEATURES

- Input Voltage Range 3.5V to 36V
- Supply Current Typ. 100 μA
- Supply Current (Standby Mode) Typ. 0.1 μA (R1511xxxxB)
- Output Voltage Range R1511xxxxB: 3.0V to 9.0V (0.1V step)
(For other voltages, please refer to MARK INFORMATIONS.)
R1511xxxxC: 3.0V to 12.0V
- Output Voltage Accuracy R1511xxxxB: $\pm 1.0\%$ ($T_a=25^{\circ}\text{C}$)
- Feed Back Voltage R1511xxxxC: 3.0V $\pm 1.0\%$ ($T_a=25^{\circ}\text{C}$)
- Output Voltage Temperature-Drift Coefficient Typ. $\pm 60\text{ppm}/^{\circ}\text{C}$
- Line Regulation Typ. 0.01%/V ($V_{\text{DD}}=V_{\text{OUT}}+0.5\text{V}$ to 36V)
- Dropout Voltage Typ. 0.64V ($I_{\text{OUT}}=300\text{mA}$, $V_{\text{OUT}}=5.0\text{V}$)
- Package Option HSOP-6J, TO-252-5-P2
- Built-in Output Short-circuit Protection Circuit Typ. 50mA
- Built-in Over-current Protection Circuit Typ. 450mA
- Built-in Thermal Shutdown Circuit Thermal Shutdown Temperature: Typ. 160°C
- Operating Temperature Range -40 to $+105^{\circ}\text{C}$
- Ripple Rejection Typ. 65dB (1kHz)
- Ceramic capacitors are recommended to be used with this IC
..... $C_{\text{IN}}=1.0\mu\text{F}$ or more, $C_{\text{OUT}}=6.8\mu\text{F}$ or more

APPLICATIONS

- For home electrical appliances: refrigerators, rice cookers, electrical pots, etc.
- For digital equipments: laptop PCs, digital TVs, telephone equipments, home LAN systems, etc.
- For OA equipments: copy machines, printers, fax machines, scanners, projectors, etc.

BLOCK DIAGRAMS

R1511xxxxB

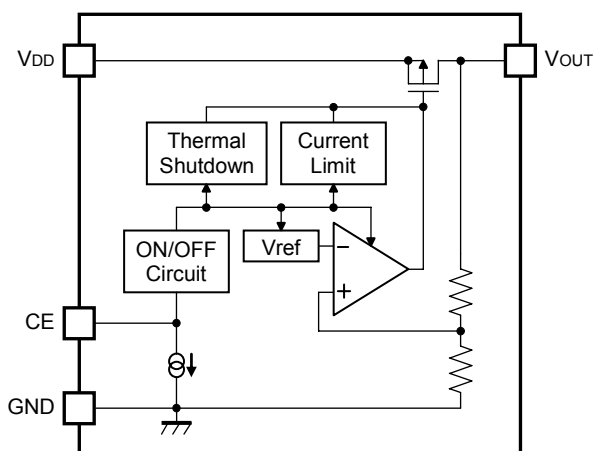

R1511x001C

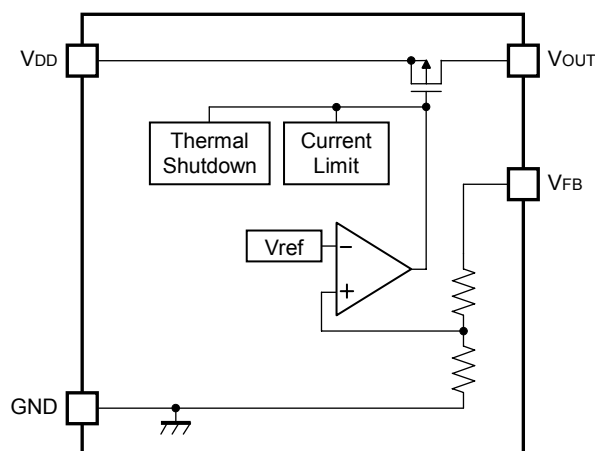

SELECTION GUIDE

The output voltage, version and the package type for the ICs can be selected at the user's request.

Product Name	Package	Quantity per Reel	Pb Free	Halogen Free
R1511Sxxx*-E2-FE	HSOP-6J	1,000pcs	Yes	Yes
R1511Jxxx*-T1-FE	TO-252-5-P2	3,000pcs	Yes	Yes

xxx : Specify the output setting voltage (V_{SET})

R1511xxxxB: Specify the output voltage within the range of 3.0V (030) to 9.0V (090) in 0.1V steps.
(For other voltages, please refer to MARK INFORMATIONS.)

R1511x001C: only (001)

* : Specify the version

(B) Fixed output and Built-in Chip Enable ("H" active)

(C) Adjustable output

PIN CONFIGURATIONS

• HSOP-6J

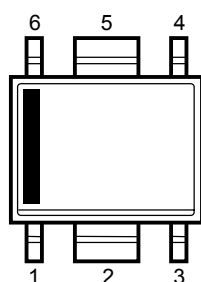

• TO-252-5-P2

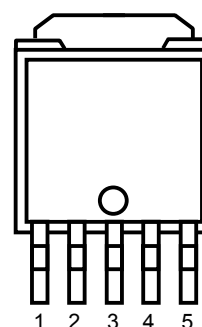

PIN DESCRIPTIONS

R1511S:HSOP-6J

Pin No.	Symbol	Description	
1	V _{DD}	Input Pin	
2	GND*	Ground Pin	
3	GND*	Ground Pin	
4	CE	R1511SxxxB	Chip Enable Pin ("H" Active)
	V _{FB}	R1511S001C	Feed Back Pin
5	GND*	Ground Pin	
6	V _{OUT}	Output Pin	

*) No. 2, No. 3 and No. 5 pins must be wired to the GND plane when they are mounted on board.

R1511J:TO-252-5-P2

Pin No.	Symbol	Description	
1	V _{DD}	Input Pin	
2	GND*	Ground Pin	
3	GND*	Ground Pin	
4	CE	R1511JxxxB	Chip Enable Pin ("H" Active)
	V _{FB}	R1511J001C	Feed Back Pin
5	V _{OUT}	Output Pin	

*) No. 2 and No. 3 pins must be wired to the GND plane when they are mounted on board.

PIN EQUIVALENT CIRCUIT DIAGRAMS

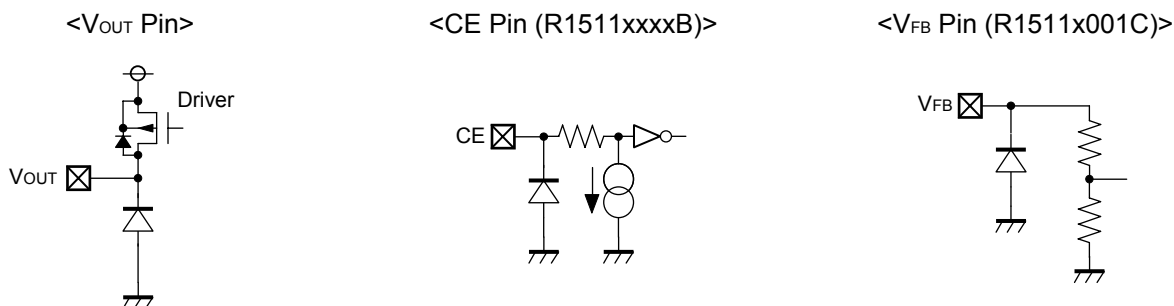

ABSOLUTE MAXIMUM RATINGS

Symbol	Item	Rating		Unit
V _{IN}	Input Voltage	-0.3 to 50		V
V _{IN}	Peak Input Voltage* ¹	60		V
V _{CE}	Input Voltage (CE Pin)	-0.3 to 50		V
V _{FB}	Input Voltage (V _{FB} Pin)	-0.3 to 50		V
V _{OUT}	Output Voltage	-0.3 to V _{IN} +0.3 ≤ 50		V
P _D	Power Dissipation (Standard Test Land Pattern)* ²	HSOP-6J	1700	mW
		TO-252-5-P2	1900	
T _j	Operating Junction Temperature Range	-40 to +125		°C
T _{stg}	Storage Temperature Range	-55 to +125		°C

*1) Duration time: 200ms

*2) For Power Dissipation, please refer to next page to be described.

ABSOLUTE MAXIMUM RATINGS

Electronic and mechanical stress momentarily exceeded absolute maximum ratings may cause the permanent damages and may degrade the lifetime and safety for both device and system using the device in the field. The functional operation at or over these absolute maximum ratings are not assured.

RECOMMENDED OPERATING CONDITIONS

Symbol	Item	Rating	Unit
T _a	Operating Temperature Range	-40 to +105	°C

RECOMMENDED OPERATING CONDITIONS (ELECTRICAL CHARACTERISTICS)

All of electronic equipment should be designed that the mounted semiconductor devices operate within the recommended operating conditions. The semiconductor devices cannot operate normally over the recommended operating conditions, even if when they are used over such conditions by momentary electronic noise or surge. And the semiconductor devices may receive serious damage when they continue to operate over the recommended operating conditions.

Power Dissipation (HSOP-6J)

This specification is at mounted on board. Power Dissipation (P_D) depends on conditions of mounting on board. This specification is based on the measurement at the condition below:

Measurement Conditions

	High Wattage Land Pattern	Standard Land Pattern
Environment	Mounting on Board (Wind velocity=0m/s)	Mounting on Board (Wind velocity=0m/s)
Board Material	Glass cloth epoxy plastic (Double-sided)	Glass cloth epoxy plastic (Double-sided)
Board Dimensions	50mm * 50mm * 1.6mm	50mm * 50mm * 1.6mm
Copper Ratio	90%	50%
Through-hole	$\phi 0.5\text{mm} * 44\text{pcs}$	$\phi 0.5\text{mm} * 44\text{pcs}$

Measurement Result

(Ta=25°C)

	High Wattage Land Pattern	Standard Land Pattern	Free Air
Power Dissipation	2000mW	1700mW	540mW
Thermal Resistance	50°C/W	59°C/W	185°C/W

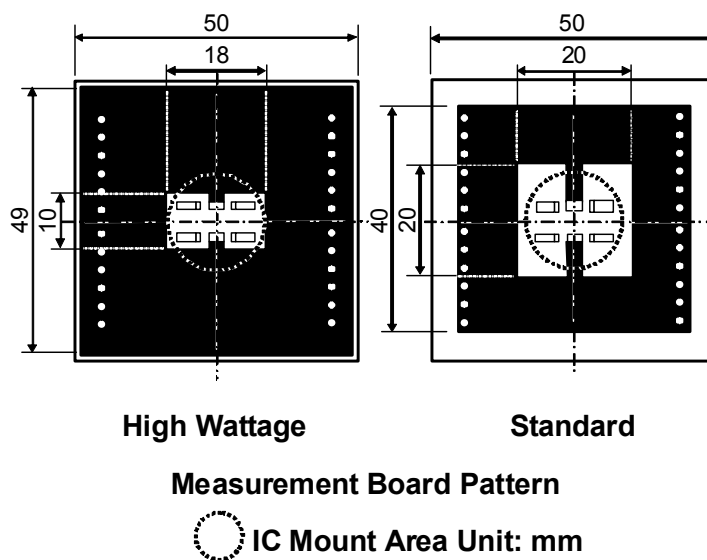
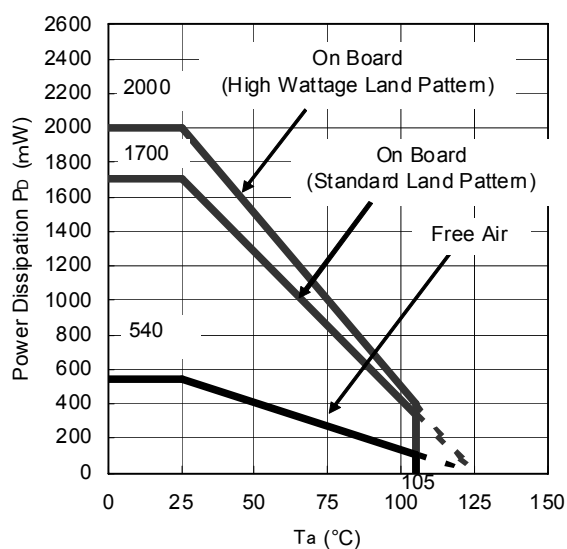

Power Dissipation

Power Dissipation (TO-252-5-P2)

This specification is at mounted on board. Power Dissipation (P_D) depends on conditions of mounting on board. This specification is based on the measurement at the condition below:

Measurement conditions

	Standard Land Pattern	High Wattage Land Pattern
Environment	Mounting on board (Wind velocity 0m/s)	Mounting on board (Wind velocity 0m/s)
Board Material	Glass cloth epoxy plastic (Double-layers)	Glass cloth epoxy plastic (Four-layers)
Board Dimensions	50mm * 50mm * 1.6mm	76.2mm * 114.3mm * 0.8mm
Copper Ratio	Top side: Approx. 50%, Back side: Approx. 50%	Top, Back side: Approx. 96%, 2nd, 3rd: 100%
Through - hole	ϕ 0.5mm * 24pcs	ϕ 0.4mm * 30pcs

Measurement Results

($T_a=25^\circ\text{C}$)

	Standard Land Pattern	High Wattage Land Pattern
Power Dissipation	1900mW	3800mW
Thermal Resistance	$\theta_{ja}=(125-25^\circ\text{C})/1.9\text{W}=53^\circ\text{C/W}$ $\theta_{jc}=17^\circ\text{C/W}$	$\theta_{ja}=(125-25^\circ\text{C})/3.8\text{W}=26^\circ\text{C/W}$ $\theta_{jc}=7^\circ\text{C/W}$

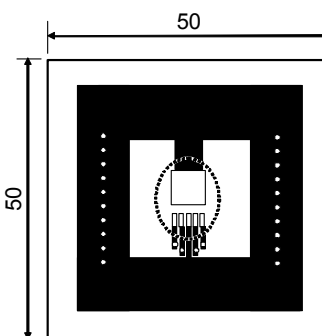
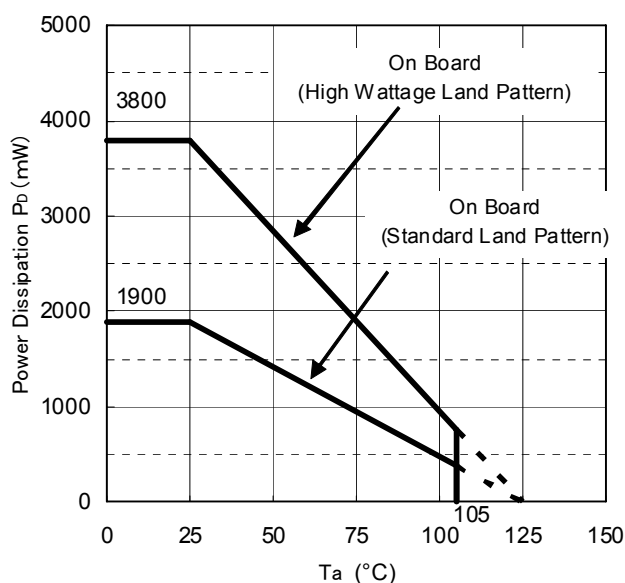

Standard

○ IC Mount Area Unit: mm

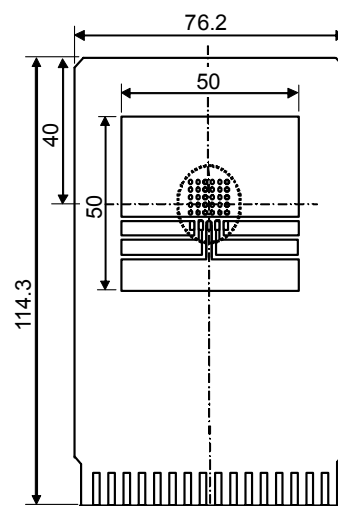

High Wattage

○ IC Mount Area Unit: mm

Power Dissipation

ELECTRICAL CHARACTERISTICS

$C_{IN}=1.0\mu F$, $C_{OUT}=6.8\mu F$, unless otherwise noted.

The specification surrounded by are guaranteed by design engineering at $-40^{\circ}C \leq T_a \leq +105^{\circ}C$.

R1511xxxxB

($T_a=25^{\circ}C$)

Symbol	Item	Conditions	Min.	Typ.	Max.	Unit	
V_{IN}	Input Voltage		3.5		36	V	
I_{SS}	Supply Current	$V_{IN}=V_{SET}+1.0V$, $I_{OUT}=0mA$		100	180	μA	
$I_{standby}$	Standby Current	$V_{IN}=36V$, $V_{CE}=0V$		0.1	2.0	μA	
V_{OUT}	Output Voltage	$V_{IN}=V_{SET}+2.0V$ $I_{OUT}=1mA$	$T_a=25^{\circ}C$	$\times 0.99$	$\times 1.01$	V	
			$-40^{\circ}C \leq T_a \leq +105^{\circ}C$	$\times 0.98$	$\times 1.02$		
$\frac{\Delta V_{OUT}}{\Delta I_{OUT}}$	Load Regulation	$V_{IN}=V_{SET}+2.0V$ $1mA \leq I_{OUT} \leq 300mA$	$V_{SET} \leq 5.0V$	-20	100	mV	
			$5.0V < V_{SET}$	-20	120		
$\frac{\Delta V_{OUT}}{\Delta V_{IN}}$	Line Regulation	$V_{SET}+0.5V \leq V_{IN} \leq 36V$, $I_{OUT}=1mA$		0.01	0.02	%/V	
V_{DIF}	Dropout Voltage	$I_{OUT}=300mA$	$3.0V \leq V_{SET} \leq 3.1V$		0.98	1.5	V
			$3.1V < V_{SET} \leq 3.4V$		0.94	1.4	
			$3.4V < V_{SET} \leq 3.8V$		0.88	1.3	
			$3.8V < V_{SET} \leq 4.3V$		0.79	1.2	
			$4.3V < V_{SET} \leq 4.9V$		0.71	1.1	
			$4.9V < V_{SET} \leq 5.7V$		0.64	1.0	
			$5.7V < V_{SET} \leq 6.8V$		0.59	0.9	
			$6.8V < V_{SET} \leq 8.3V$		0.54	0.8	
		$8.3V < V_{SET} \leq 9.0V$		0.47	0.7		
$\frac{\Delta V_{OUT}}{\Delta T_a}$	Output Voltage Temperature Coefficient	$V_{IN}=V_{SET}+2.0V$, $I_{OUT}=1mA$ $-40^{\circ}C \leq T_a \leq +105^{\circ}C$		± 60		ppm/ $^{\circ}C$	
I_{LIM}	Output Current Limit	$V_{IN}=V_{SET}+2.5V$		450		mA	
I_{SC}	Short Current Limit	$V_{OUT}=0V$		50		mA	
RR	Ripple Rejection	$f=1kHz$, Ripple=0.5Vpp $I_{OUT}=10mA$, $V_{IN}=V_{SET}+2.0V$		65		dB	
V_{CEH}	CE Input Voltage "H"		2.2		36	V	
V_{CEL}	CE Input Voltage "L"		0		1.0	V	
I_{PD}	CE Pull-down Current	$V_{CE}=5.0V$		0.2	0.6	μA	
		$V_{CE}=36V$		0.5	1.3		
T_{TSD}	Thermal Shutdown Temperature	Junction Temperature		160		$^{\circ}C$	
T_{TSR}	Thermal Shutdown Released Temperature	Junction Temperature		135		$^{\circ}C$	

All test items listed under Electrical Characteristics are done under the pulse load condition ($T_j \approx T_a = 25^{\circ}C$) except for Ripple Rejection and Output Voltage Temperature Coefficient.

$C_{IN}=1.0\mu F$, $C_{OUT}=6.8\mu F$, $V_{OUT}=V_{FB}$, unless otherwise noted.

The specification surrounded by are guaranteed by design engineering at $-40^{\circ}\text{C} \leq T_a \leq +105^{\circ}\text{C}$.

R1511x001C

(T_a=25°C)

Symbol	Item	Conditions	Min.	Typ.	Max.	Unit
V _{IN}	Input Voltage		3.5		3.6	V
I _{SS}	Supply Current	V _{IN} =4.0V, I _{OUT} =0mA		100	180	μA
V _{OUT}	Output Voltage	V _{IN} =5.0V I _{OUT} =1mA				V
		T _a =25°C	2.97		3.03	
		-40°C ≤ T _a ≤ +105°C	2.94		3.06	
ΔV _{OUT} /ΔI _{OUT}	Load Regulation	V _{IN} =5.0V 1mA ≤ I _{OUT} ≤ 300mA	-20		40	mV
ΔV _{OUT} /ΔV _{IN}	Line Regulation	V _{SET} +0.5V ≤ V _{IN} ≤ 36V I _{OUT} =1mA		0.01	0.02	%/V
V _{DIF}	Dropout Voltage	I _{OUT} =300mA		0.98	1.5	V
ΔV _{OUT} /ΔT _a	Output Voltage Temperature Coefficient	V _{IN} =V _{SET} +2.0V, I _{OUT} =1mA -40°C ≤ T _a ≤ +105°C		±60		ppm /°C
I _{LIM}	Output Current Limit	V _{IN} = V _{SET} +2.5V		450		mA
I _{SC}	Short Current Limit	V _{OUT} =0V		50		mA
RR	Ripple Rejection	f=1kHz, Ripple=0.5Vpp I _{OUT} =10mA, V _{IN} =V _{SET} +2.0V		65		dB
R _{FB}	V _{FB} Pin Resistanse		1.0	3.0		MΩ
T _{TSD}	Thermal Shutdown Temperature	Junction Temperature		160		°C
T _{TSR}	Thermal Shutdown Released Temperature	Junction Temperature		135		°C

All test items listed under Electrical Characteristics are done under the pulse load condition (T_j=T_a=25°C) except for Ripple Rejection and Output Voltage Temperature Coefficient.

TYPICAL APPLICATIONS

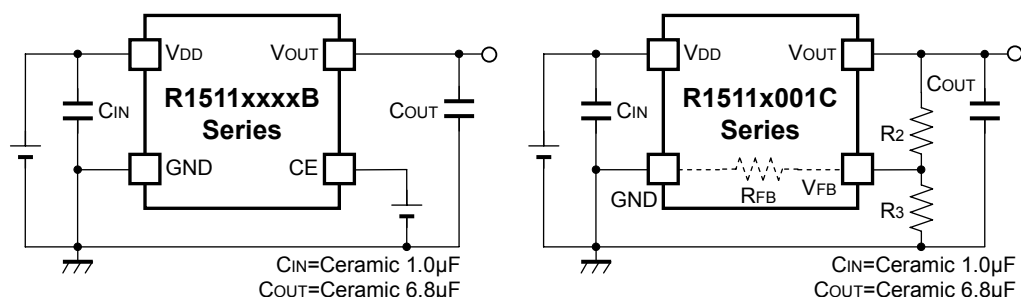

NOTES CONCERNING EXTERNAL PARTS

Phase Compensation

In the R1511x Series, phase compensation is provided to secure stable operation even when the load current is varied. For this purpose, please make sure to use a C_{OUT} capacitor.

In case of using a tantalum type capacitor and the ESR (Equivalent Series Resistance) value of the capacitor is large, the output might be unstable. Evaluate the circuit including consideration of frequency characteristics.

Depending on the capacitor size, manufacturer, and part number, the bias characteristics and temperature characteristics are different. Evaluate the circuit taking actual characteristics into account.

PCB Layout and GND Wiring

Ensure the V_{DD} and GND lines are sufficiently robust. If their impedance is too high, noise pickup or unstable operation may result. Connect a C_{IN} capacitor with $1.0\mu\text{F}$ or more value between the V_{DD} and GND pins, and as close as possible to the pins. Likewise, connect a C_{OUT} capacitor with suitable values between the V_{OUT} and GND pins, and as close as possible to the pins (Please refer to the Typical Application above).

In the case of using HSOP-6J package, please make sure to wire No. 2, No. 3, and No. 5 pins to the GND plane. Also, in the case of using TO-252-5-P2 package, please make sure to wire No. 2 and No. 3 pins to the GND plane.

Thermal Shutdown

R1511x contains a thermal shutdown circuit, which stops regulator operation if the junction temperature of R1511x becomes higher than 160°C (Typ.). Additionally, if the junction temperature after the regulator being stopped decreases to a level below 135°C (Typ.), it restarts regulator operation. As a result the operation of the thermal shutdown circuit causes the regulator repeatedly to turn off and on until the causes of overheating are removed. As a consequence a pulse shaped output voltage occurs.

Output Voltage Setting Method (R1511x001C)

R1511x001C can be adjusted the output voltage up to 12.0V by using the external divider resistors. The output voltage can be calculated by the following equation.

$$V_{OUT} = V_{FB} \times (R_2 + R_3) / R_3$$

However, output voltage will be as large as " $R_2 \times I_{FB}$ " by the current flowing through the resistor in the IC. Because $I_{FB} = V_{FB} / R_{FB}$, " $R_2 \times I_{FB}$ " cause of error is as follows.

$$R_2 \times I_{FB} = R_2 \times V_{FB} / R_{FB} = V_{FB} \times R_2 / R_{FB}$$

For better accuracy, choosing $R_2 \ll R_{FB}$ reduces this error. R_{FB} of R1511x is approximately min $1.0\text{M}\Omega$ (guaranteed by design).

TEST CIRCUITS.

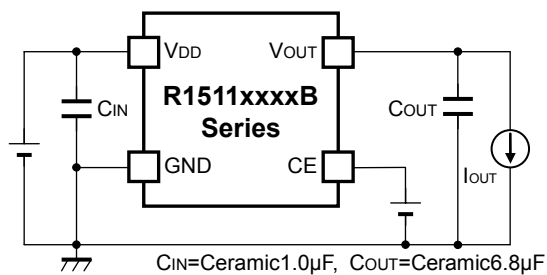

R1511xxxxB Basic Test Circuit

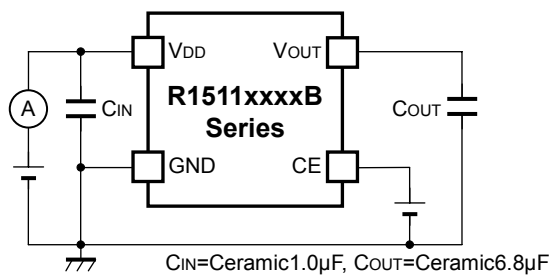

R1511xxxxB Test Circuit for Supply Current

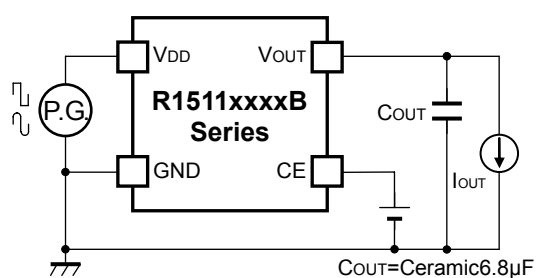

R1511xxxxB Test Circuit for Ripple Rejection and Regulator Input Transient Response

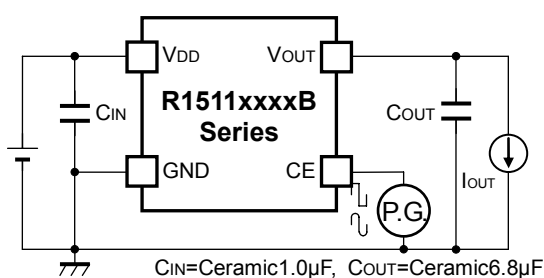

R1511xxxxB Test Circuit for CE Start-up

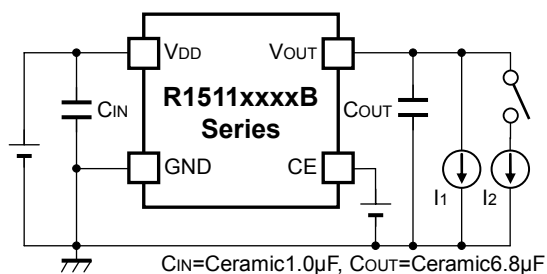

R1511xxxxB Test Circuit for Load Transient Response

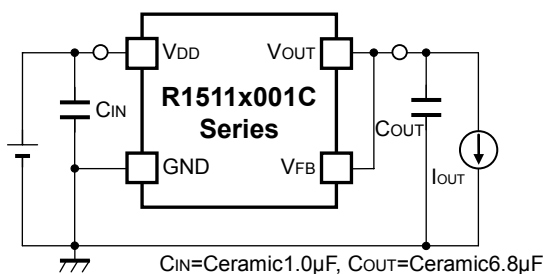

R1511x001C Basic Test Circuit

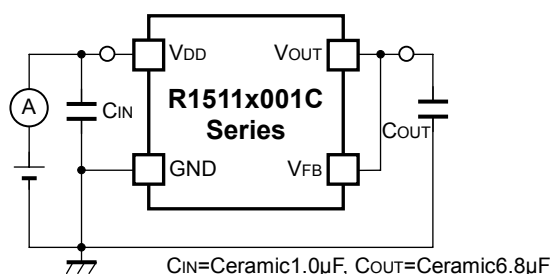

R1511x001C Test Circuit for Supply Current

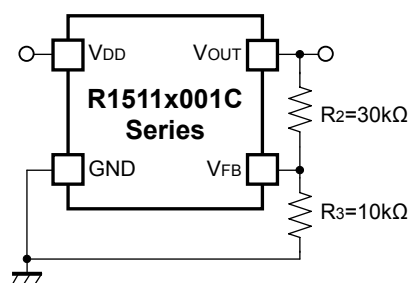

R1511x001C Case of output voltage adjustment by external resistors

TYPICAL CHARACTERISTICS

(1) Output Voltage Vs. Output Current ($T_a=25^\circ\text{C}$)

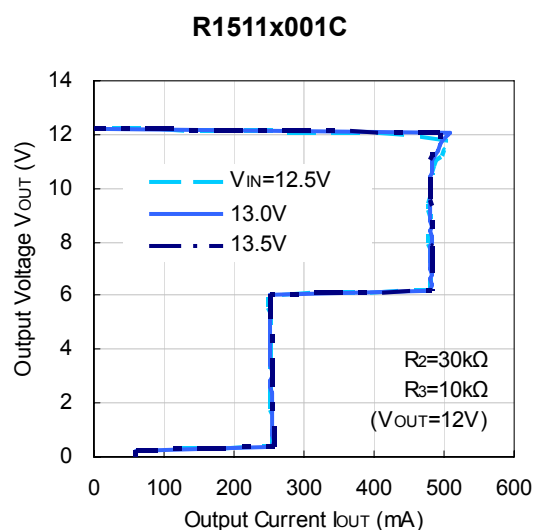
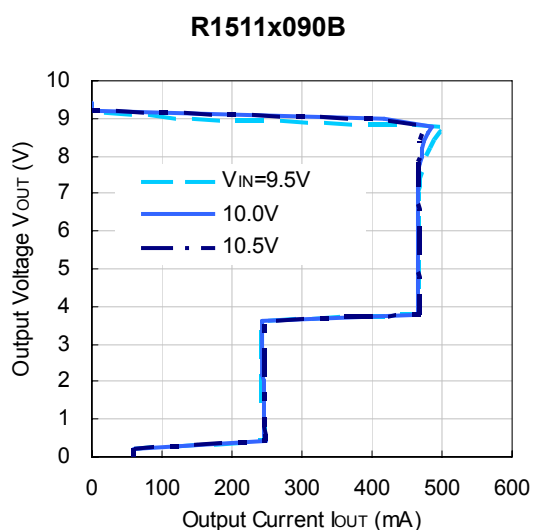
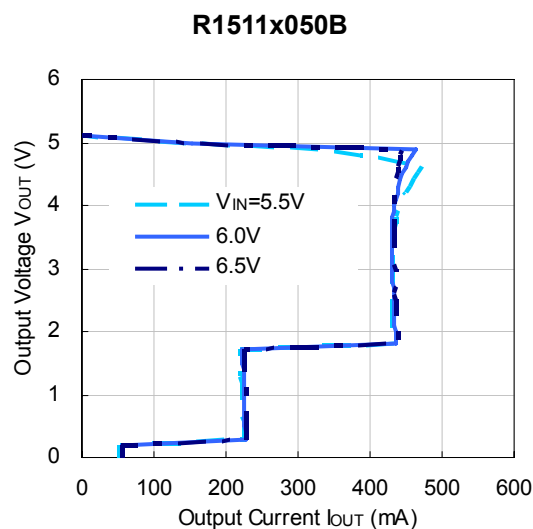
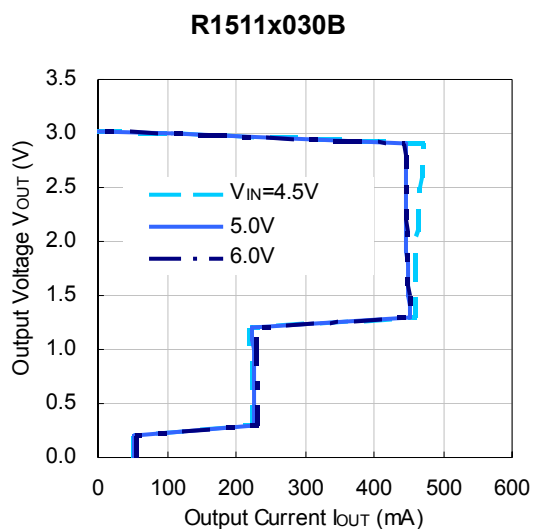

2) Output Voltage Vs. Input Voltage ($T_a=25^\circ\text{C}$)

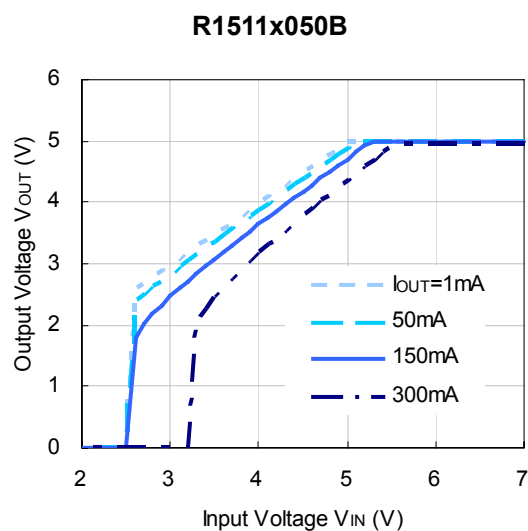
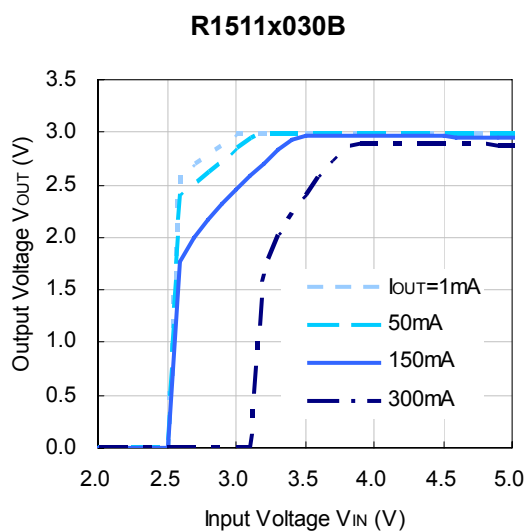

R1511x090B

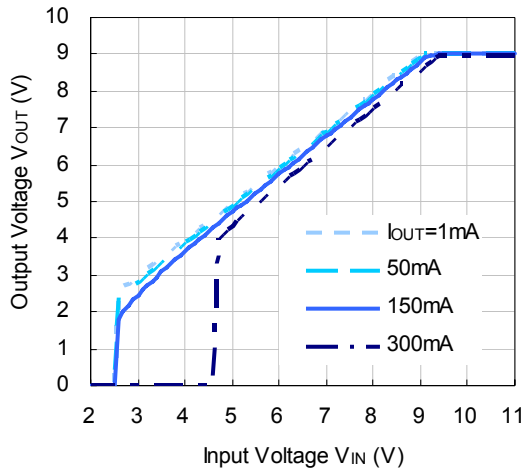

R1511x001C

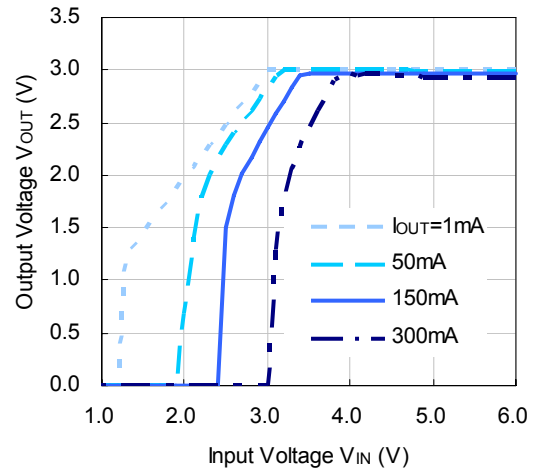

3) Supply Current Vs. Input Voltage

R1511x030B

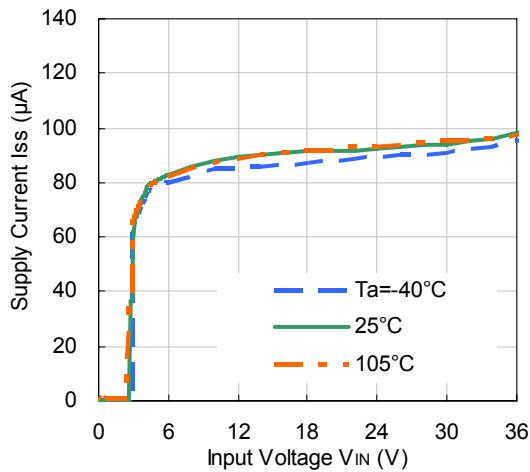

R1511x050B

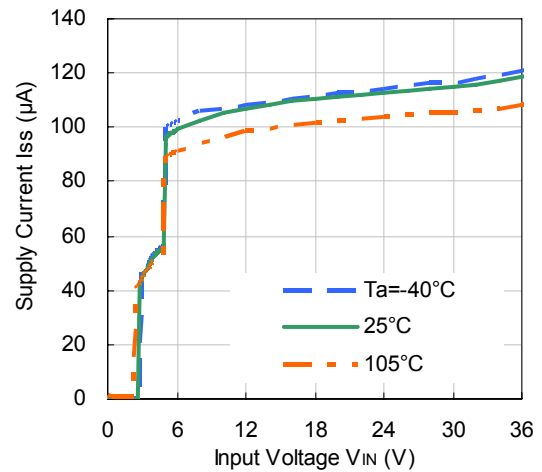

R1511x090B

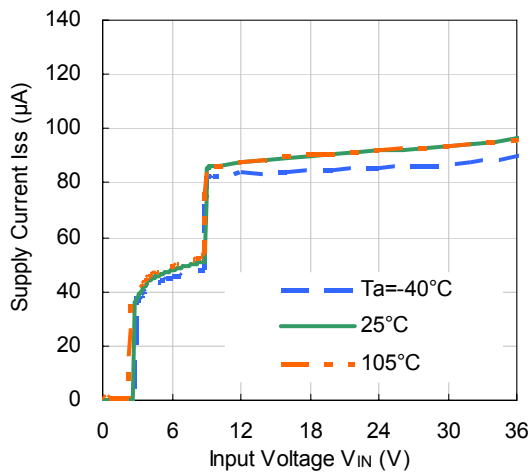

R1511x001C

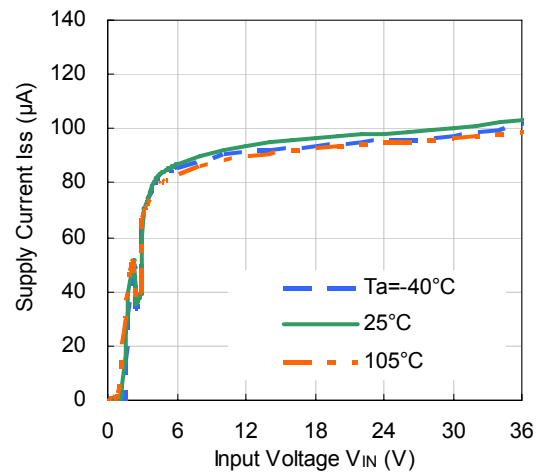

4) Output Voltage Vs. Ambient Temperature

R1511x030B

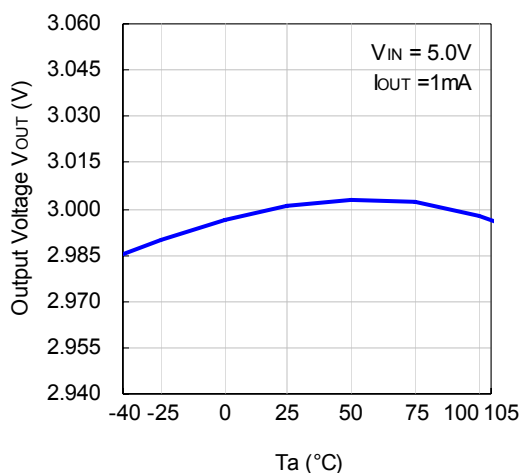

R1511x050B

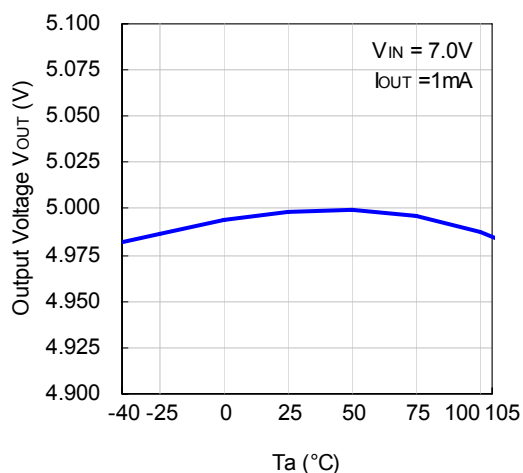

R1511x090B

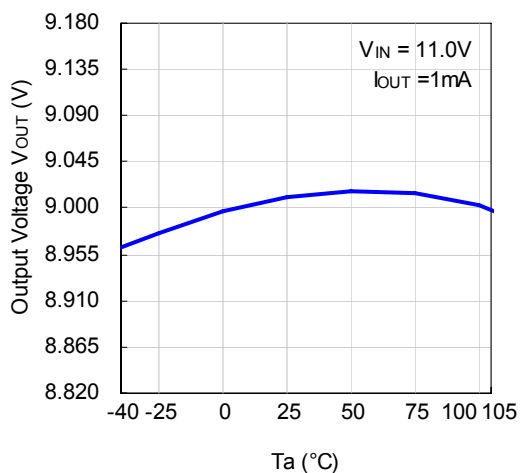

R1511x001C

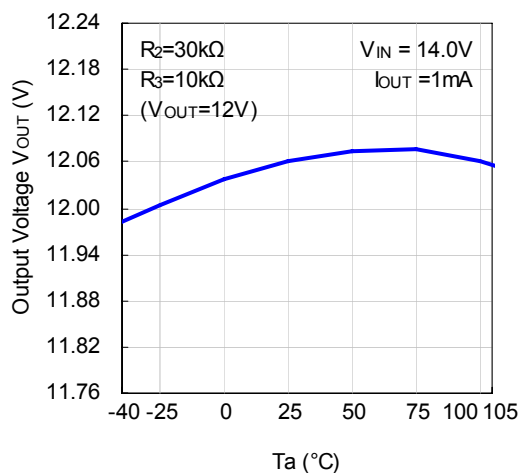

5) Dropout Voltage Vs. Output Current

R1511x030B/R1511x001C

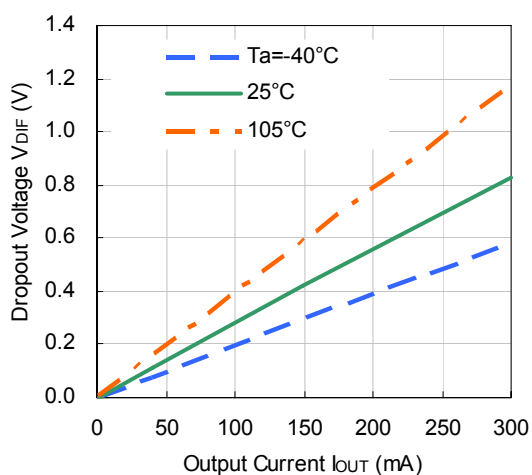

R1511x050B

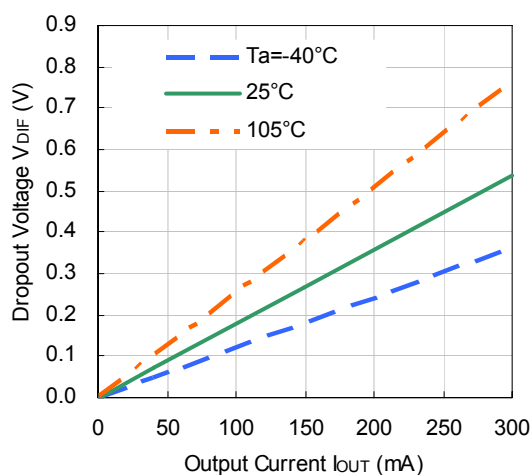

R1511x090B

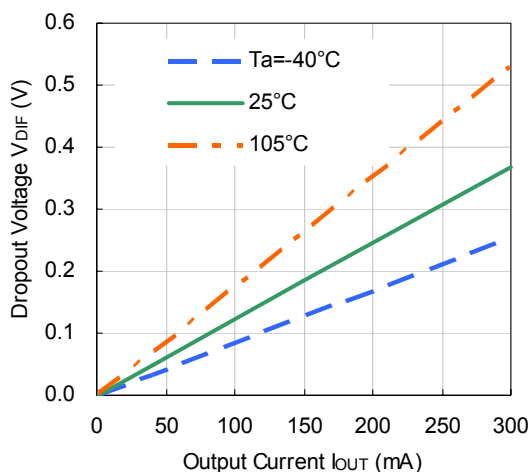

6) Dropout Voltage Vs. Setting Voltage (Ta=25°C)

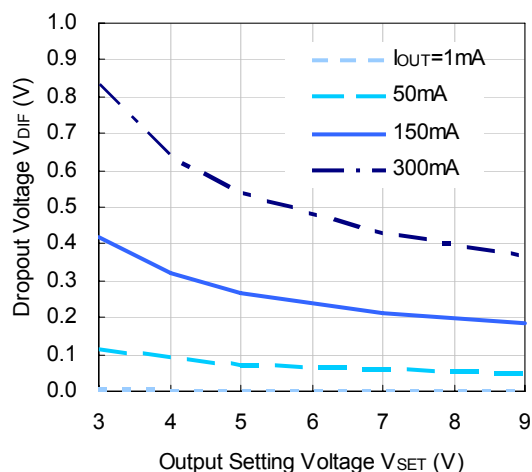

7) Ripple Rejection Vs. Input Bias Voltage (Ta=25°C, Ripple=0.5V_{pp})

R1511x030B/R1511x001C (I_{OUT}=1mA)

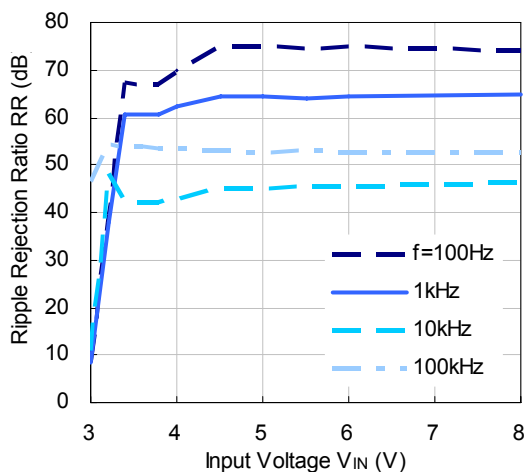

R1511x030B/R1511x001C (I_{OUT}=100mA)

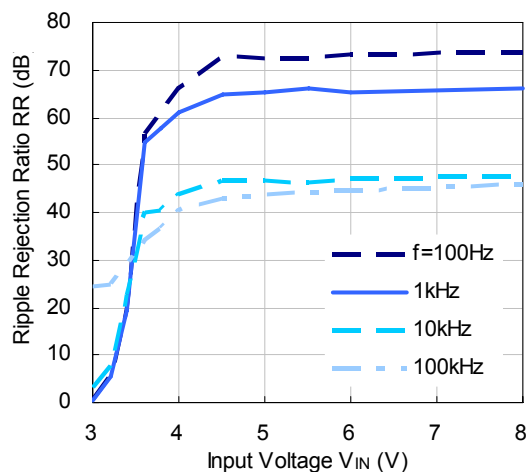

R1511x050B (I_{OUT}=1mA)

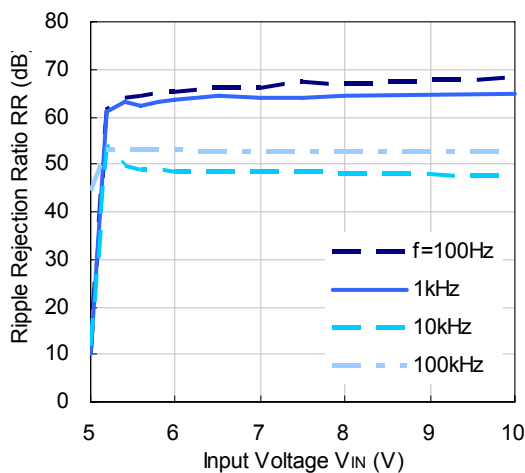

R1511x050B (I_{OUT}=100mA)

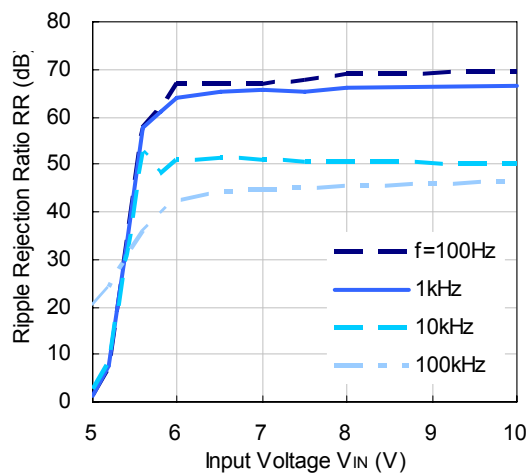

R1511x090B (I_{OUT}=1mA)

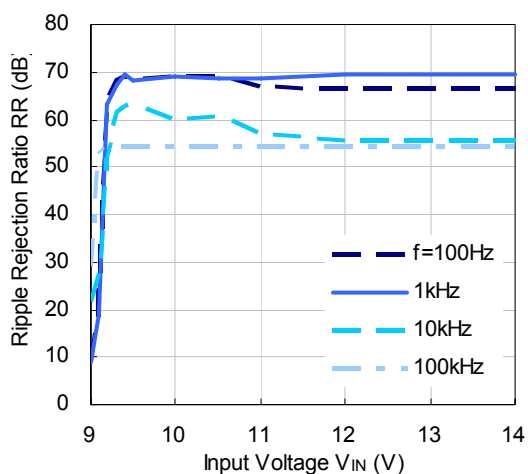

R1511x090B (I_{OUT}=100mA)

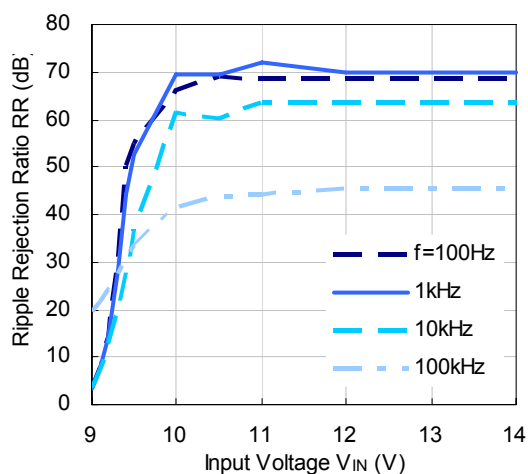

8) Ripple Rejection Vs. Frequency (Ta=25°C, Ripple=0.5V_{pp})

R1511x030B/R1511x001C

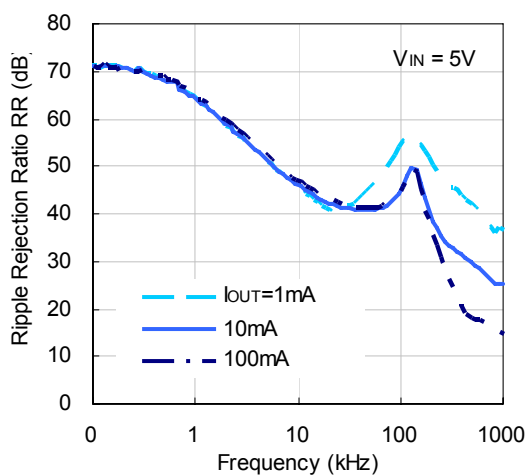

R1511x050B

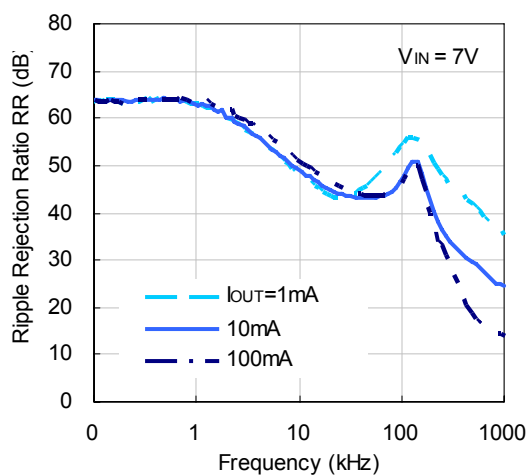

R1511x090B

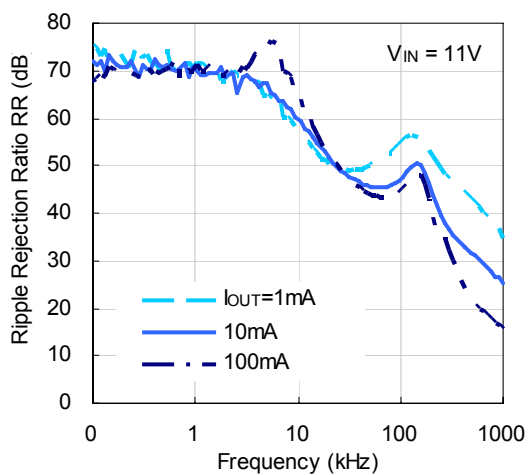

10) Input Transient Response (Ta=25°C)

R1511x030B

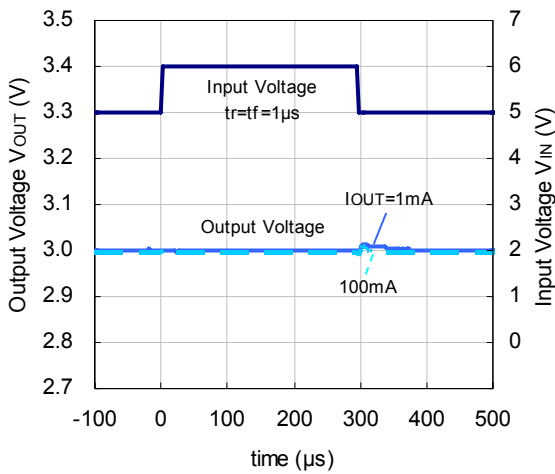

R1511x050B

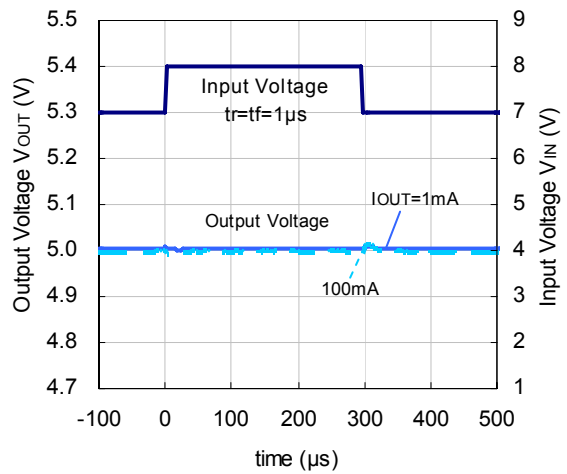

R1511x090B

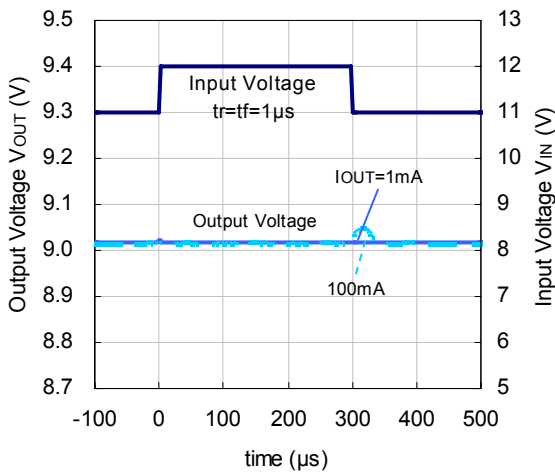

10) Load Transient Response (Ta=25°C)

R1511x030B

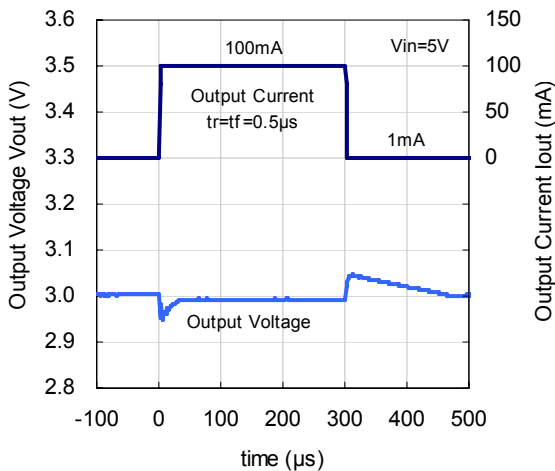

R1511x050B

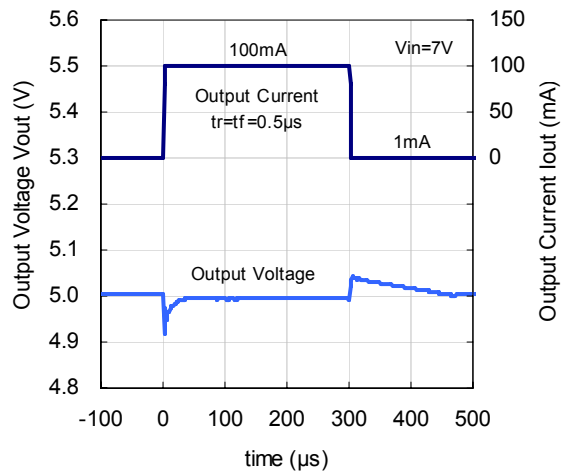

R1511x090B

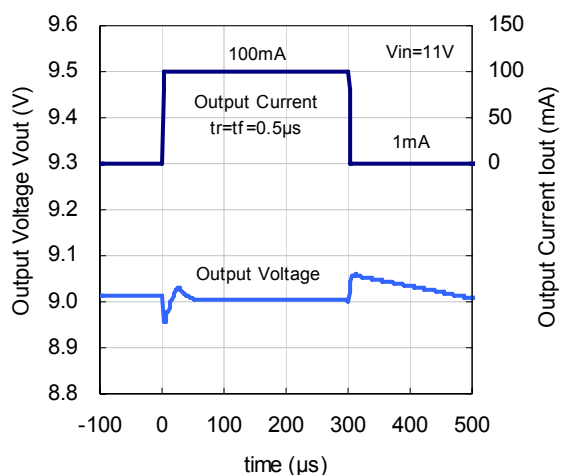

11) CE Response ($T_a=25^\circ C$)

R1511x030B (Turn On)

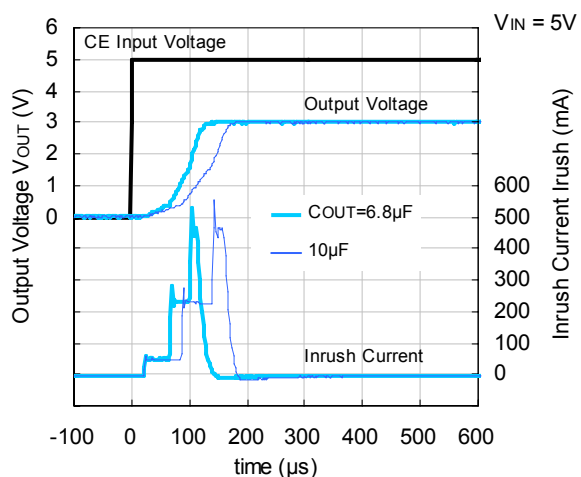

R1511x030B (Turn Off)

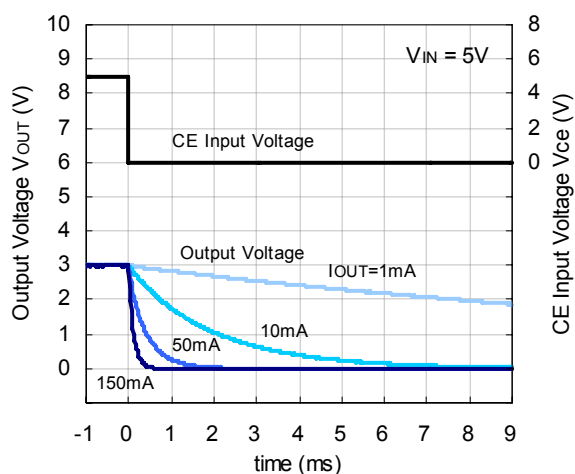

R1511x050B (Turn On)

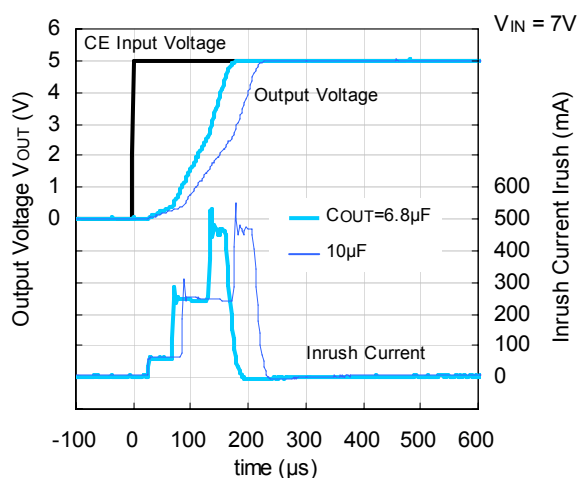

R1511x050B (Turn Off)

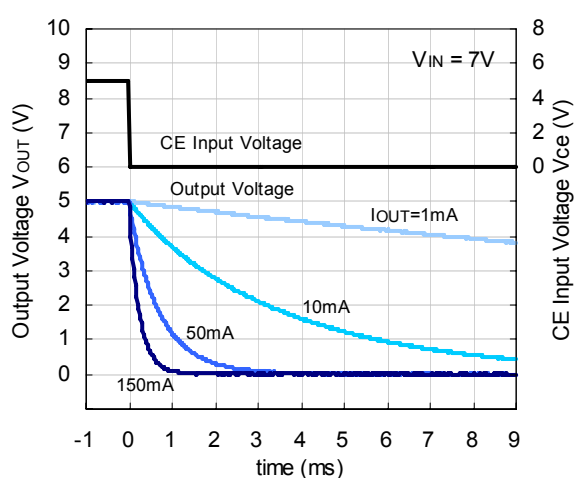

R1511x090B (Turn On)

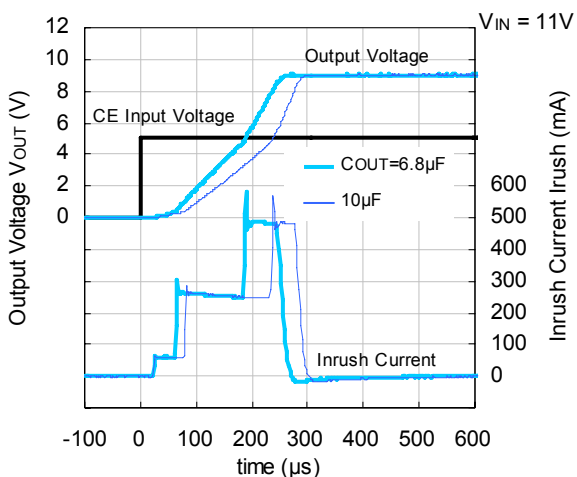

R1511x090B (Turn Off)

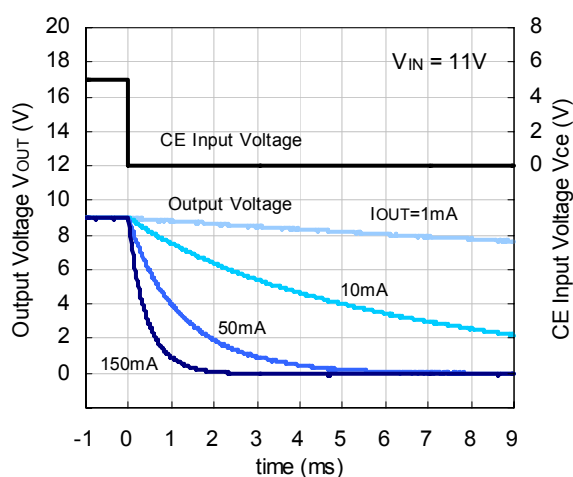

12) Start Up Waveform ($T_a = 25^\circ C$)

R1511x030B

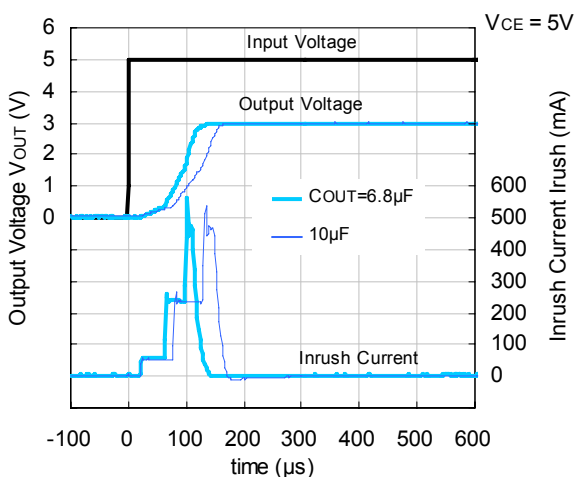

R1511x001C

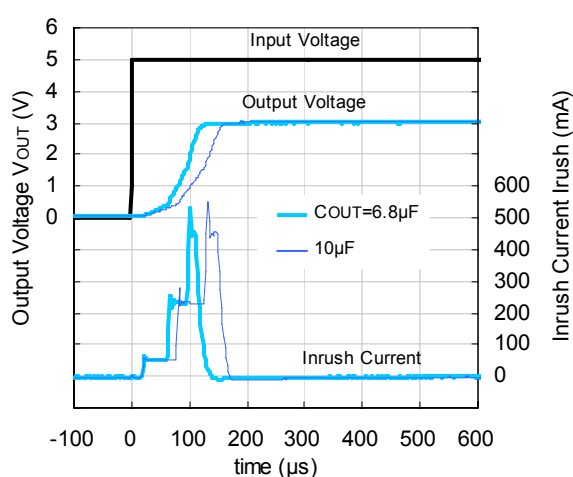

13) CE Pin Current Vs. CE Input Voltage

R1511xxxxB

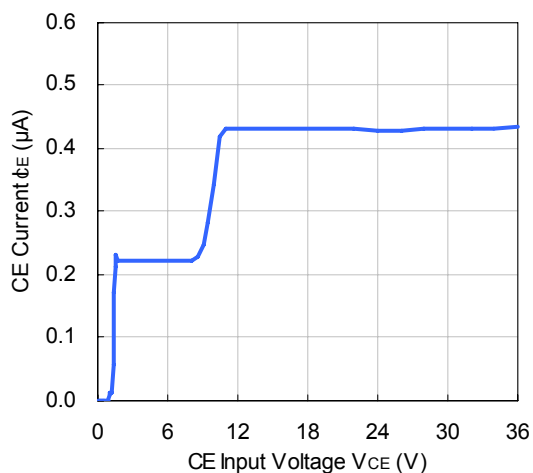

EFFECTIVE SERIES RESISTANCE (ESR) VS. OUTPUT CURRENT

Ceramic type output capacitor is recommended for this series; however, the other output capacitors with low ESR also can be used. As for reference, the below graphs show the relationship between output current (I_{OUT}) and effective series resistance (ESR). The noise level of the output current (I_{OUT}) was measured by the test circuit and is lower than the specified value.

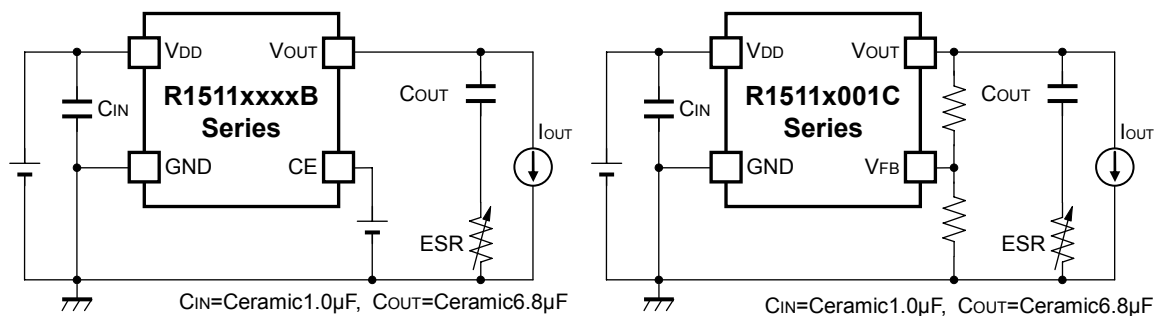

Measurement Conditions

- Noise Frequency Range: 10Hz to 1MHz
- Ambient Temperature: -40°C to 105°C
- Shaded Area: Noise level is lower than the specified value (40 μ V)
- Capacitor: C_{IN} =Ceramic 1.0 μ F, C_{OUT} =Ceramic 6.8 μ F (C4532X7S1H685K)

R1511x030B

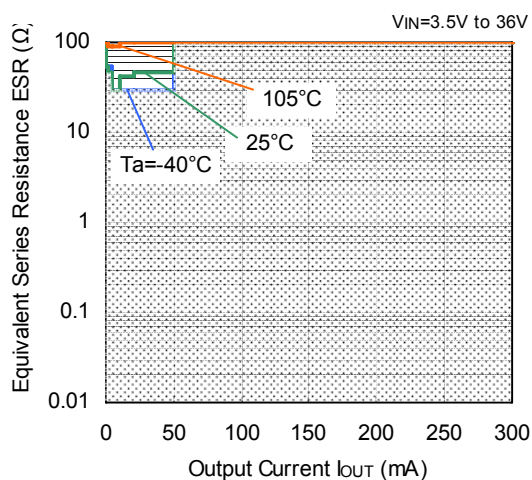

R1511x050B

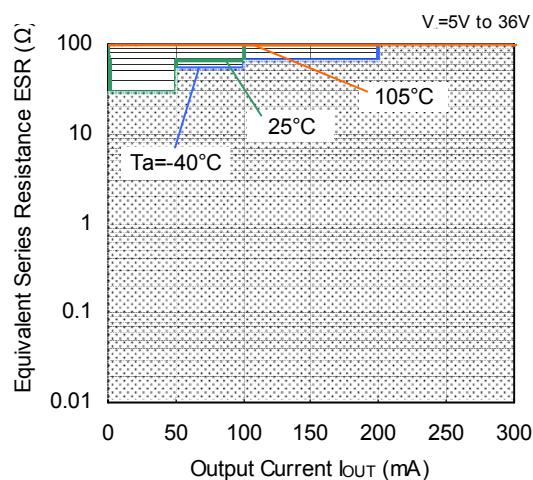

R1511x090B

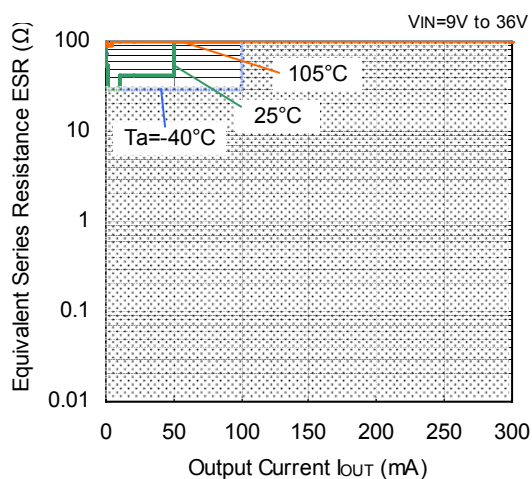

R1511x001C (V_{OUT} =12V)

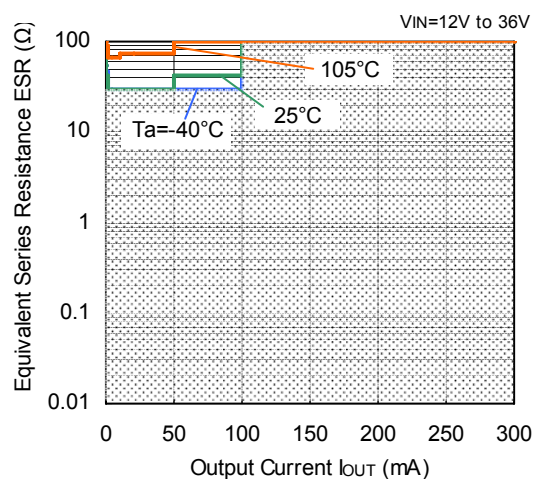



1. The products and the product specifications described in this document are subject to change or discontinuation of production without notice for reasons such as improvement. Therefore, before deciding to use the products, please refer to Ricoh sales representatives for the latest information thereon.
2. The materials in this document may not be copied or otherwise reproduced in whole or in part without prior written consent of Ricoh.
3. Please be sure to take any necessary formalities under relevant laws or regulations before exporting or otherwise taking out of your country the products or the technical information described herein.
4. The technical information described in this document shows typical characteristics of and example application circuits for the products. The release of such information is not to be construed as a warranty of or a grant of license under Ricoh's or any third party's intellectual property rights or any other rights.
5. The products listed in this document are intended and designed for use as general electronic components in standard applications (office equipment, telecommunication equipment, measuring instruments, consumer electronic products, amusement equipment etc.). Those customers intending to use a product in an application requiring extreme quality and reliability, for example, in a highly specific application where the failure or misoperation of the product could result in human injury or death (aircraft, spacevehicle, nuclear reactor control system, traffic control system, automotive and transportation equipment, combustion equipment, safety devices, life support system etc.) should first contact us.
6. We are making our continuous effort to improve the quality and reliability of our products, but semiconductor products are likely to fail with certain probability. In order to prevent any injury to persons or damages to property resulting from such failure, customers should be careful enough to incorporate safety measures in their design, such as redundancy feature, fire containment feature and fail-safe feature. We do not assume any liability or responsibility for any loss or damage arising from misuse or inappropriate use of the products.
7. Anti-radiation design is not implemented in the products described in this document.
8. The X-ray exposure can influence functions and characteristics of the products. Confirm the product functions and characteristics in the evaluation stage.
9. WLCSP products should be used in light shielded environments. The light exposure can influence functions and characteristics of the products under operation or storage.
10. There can be variation in the marking when different AOI (Automated Optical Inspection) equipment is used. In the case of recognizing the marking characteristic with AOI, please contact Ricoh sales or our distributor before attempting to use AOI.
11. Please contact Ricoh sales representatives should you have any questions or comments concerning the products or the technical information.



Ricoh is committed to reducing the environmental loading materials in electrical devices with a view to contributing to the protection of human health and the environment.

Ricoh has been providing RoHS compliant products since April 1, 2006 and Halogen-free products since April 1, 2012.

RICOH RICOH ELECTRONIC DEVICES CO., LTD.

<http://www.e-devices.ricoh.co.jp/en/>

Sales & Support Offices

RICOH ELECTRONIC DEVICES CO., LTD.

Higashi-Shinagawa Office (International Sales)
3-32-3, Higashi-Shinagawa, Shinagawa-ku, Tokyo 140-8655, Japan
Phone: +81-3-5479-2857 Fax: +81-3-5479-0502

RICOH EUROPE (NETHERLANDS) B.V.

Semiconductor Support Centre
Prof. W.H. Keesomlaan 1, 1183 DJ Amstelveen, The Netherlands
Phone: +31-20-5474-309

RICOH INTERNATIONAL B.V. - German Branch

Semiconductor Sales and Support Centre
Oberrather Strasse 6, 40472 Düsseldorf, Germany
Phone: +49-211-6546-0

RICOH ELECTRONIC DEVICES KOREA CO., LTD.

3F, Haesung Bldg, 504, Teheran-ro, Gangnam-gu, Seoul, 135-725, Korea
Phone: +82-2-2135-5700 Fax: +82-2-2051-5713

RICOH ELECTRONIC DEVICES SHANGHAI CO., LTD.

Room 403, No.2 Building, No.690 Bibo Road, Pu Dong New District, Shanghai 201203, People's Republic of China
Phone: +86-21-5027-3200 Fax: +86-21-5027-3299

RICOH ELECTRONIC DEVICES CO., LTD.

Taipei office
Room 109, 10F-1, No.51, Hengyang Rd., Taipei City, Taiwan (R.O.C.)
Phone: +886-2-2313-1621/1622 Fax: +886-2-2313-1623