PWM Step-up DC/DC Controller

NO.EA-109-160115

OUTLINE

The R1212D is a CMOS-based PWM step-up DC/DC controller with low supply current. Internally, the R1212D consists of an oscillator, a PWM comparator circuit, a reference voltage unit, an error amplifier, a reference current unit, a protection circuit, and an under voltage lockout (UVLO) circuit. A low ripple, high efficiency step-up DC/DC converter can be composed of this IC with some external components, or an inductor, a diode, a power MOSFET, divider resistors, and capacitors.

The maximum duty cycle and the soft start time are easily adjustable with external resistors and capacitors. In terms of maximum duty cycle, with or without internal limit can be set by mask options. As for the protection circuit, after the soft-starting time, if the maximum duty cycle is continued for a certain period, the R1212D latches the external driver with its off state, or the latch-type protection circuit works. The delay time for latch the state can be set with an external capacitor. To release the protection circuit, restart with power-on (Voltage supplier is equal or less than UVLO detector threshold level).

FEATURES

- Input Voltage Range 2.2 V to 5.5 V
- Built-in Latch-type Protection Function (Output Delay Time can be set with an external capacitor)
- Two Options of Basic Oscillator Frequency..... 700 kHz, 1.4 MHz, 300 kHz
- Maximum Duty Cycle/Soft-start time Adjustable with external capacitors
(If internal limit is set by version, Typ. 90% or Typ. 91.5%)
- High Reference Voltage Accuracy $\pm 1.5\%$
- UVLO Threshold level Typ. 1.9 V/ 2.1 V/ 2.8 V by mask option
- Small Temperature Coefficient of Reference Voltage Typ. $\pm 150\text{ppm}/^\circ\text{C}$
- Package..... SON-8

APPLICATIONS

- Constant Voltage Power Source for portable equipment
- Constant Voltage Power Source for LCD and CCD

BLOCK DIAGRAM

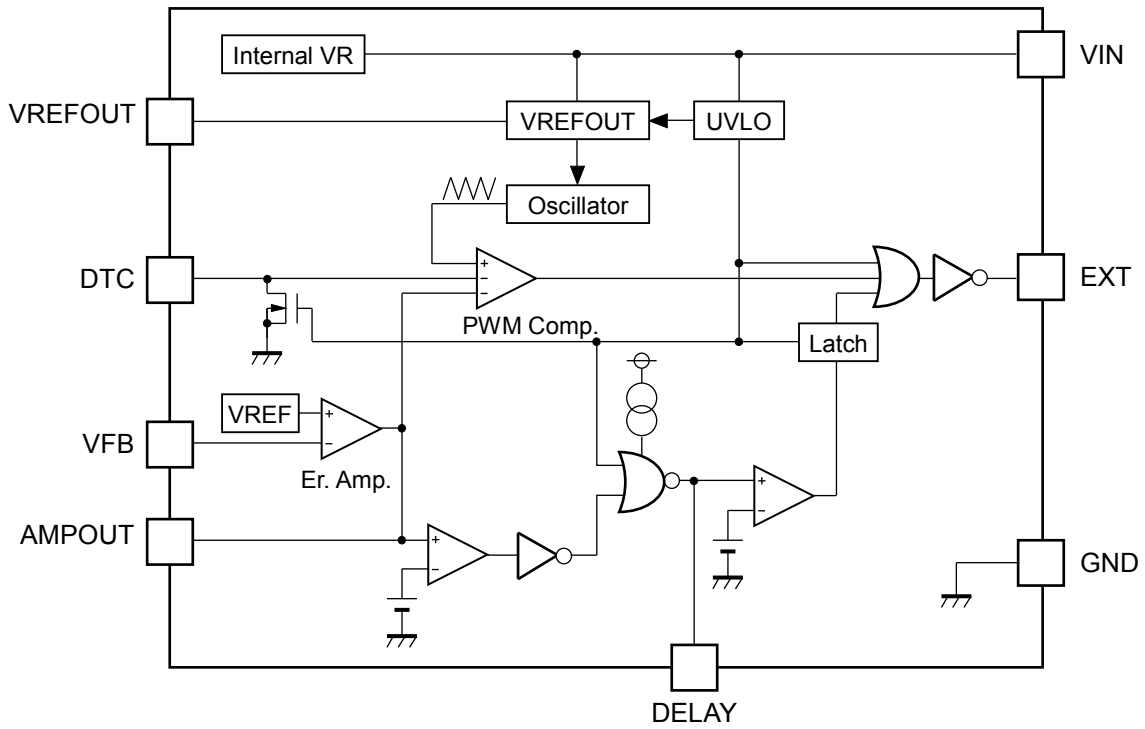

R1212D Block Diagram

SELECTION GUIDE

The oscillator frequency, UVLO detector threshold, and oscillator maximum duty cycle internal limit for the ICs can be selected at the user's request.

Selection Guide

Product Name	Package	Quantity per Reel	Pb Free	Halogen Free
R1212D10xx-TR-FE	SON-8	3,000 pcs	Yes	Yes

xx: The combination of the oscillator frequency, oscillator maximum duty cycle internal limit, and UVLO detect voltage can be designated.

Code	Oscillator Frequency	UVLO Detector Threshold	Internal Maximum Duty Limit
0A	Typ. 700 kHz	Typ. 1.9 V	No
0B	Typ. 1.4 MHz	Typ. 1.9 V	No
1A	Typ. 700 kHz	Typ. 2.1 V	Typ. 90%
1C	Typ. 300 kHz	Typ. 2.1 V	Typ. 91.5%
2A	Typ. 700 kHz	Typ. 2.8 V	Typ. 90%
2C	Typ. 300 kHz	Typ. 2.8 V	Typ. 91.5%

PIN CONFIGURATION

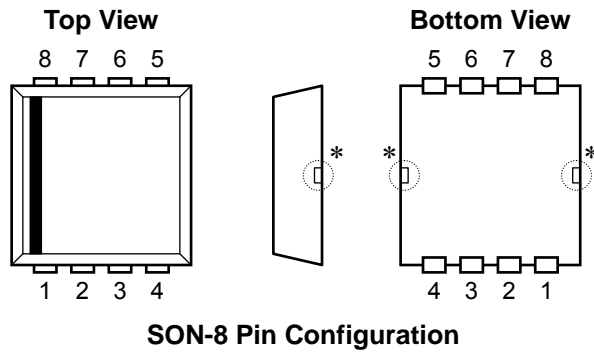

PIN DESCRIPTION

Pin Description

Pin No	Symbol	Description
1	EXT	External FET Drive Pin (CMOS Output)
2	GND	Ground Pin
3	DTC	Pin for Setting Maximum Duty Cycle and Soft start time
4	DELAY	Pin for External Capacitor (for Setting Output Delay of Protection)
5	VFB	Feedback Pin for monitoring Output Voltage
6	VREFOUT	Reference Voltage Output Pin
7	AMPOUT	Amplifier Output Pin
8	VIN	Power Supply Pin for the IC

* Tab suspension leads are GND level. (They are connected to the reverse side of this IC.) The tab suspension leads should be open and do not connect to other wires or land patterns.

ABSOLUTE MAXIMUM RATINGS

Absolute Maximum Ratings

(GND = 0 V)

Symbol	Item	Rating	Unit
V_{IN}	VIN Pin Voltage	6.5	V
V_{EXT}	EXT Pin Output Voltage	$-0.3 \sim V_{IN} + 0.3$	V
V_{DLY}	DELAY Pin Voltage	$-0.3 \sim V_{IN} + 0.3$	V
V_{REFOUT}	VREFOUT Pin Voltage	$-0.3 \sim V_{IN} + 0.3$	V
V_{AMP}	AMPOUT Pin Voltage	$-0.3 \sim V_{IN} + 0.3$	V
V_{FB}	DTC Pin Voltage	$-0.3 \sim V_{IN} + 0.3$	V
V_{DTC}	VFB Pin Voltage	$-0.3 \sim V_{IN} + 0.3$	V
I_{AMP}	AMPOUT Pin Current	± 10	V
I_{ROUT}	VREFOUT Pin Current	30	mA
I_{EXT}	EXT Pin Inductor Drive Output Current	± 80	mA
P_D	Power Dissipation (SON-8) (Standard Test Land Pattern)*	480	mW
T_{opt}	Operating Temperature Range	$-40 \sim 85$	$^{\circ}\text{C}$
T_{stg}	Storage Temperature Range	$-55 \sim 125$	$^{\circ}\text{C}$

* For Power Dissipation, please refer to PACKAGE INFORMATION.

ABSOLUTE MAXIMUM RATINGS

Electronic and mechanical stress momentarily exceeded absolute maximum ratings may cause the permanent damages and may degrade the life time and safety for both device and system using the device in the field. The functional operation at or over these absolute maximum ratings is not assured.

RECOMMENDED OPERATING CONDITIONS (ELECTRICAL CHARACTERISTICS)

All of electronic equipment should be designed that the mounted semiconductor devices operate within the recommended operating conditions. The semiconductor devices cannot operate normally over the recommended operating conditions, even if when they are used over such conditions by momentary electronic noise or surge. And the semiconductor devices may receive serious damage when they continue to operate over the recommended operating conditions.

R1212D

NO.EA-109-160115

ELECTRICAL CHARACTERISTICS**R1212D100A Electrical Characteristics**

(Topt = 25°C)

Symbol	Item	Conditions	Min.	Typ.	Max.	Unit
V _{IN}	Operating Input Voltage		2.2		5.5	V
V _{FB}	VFB Voltage Tolerance	V _{IN} = 3.3 V	0.985	1.000	1.015	V
$\frac{\Delta V_{FB}}{\Delta V_{IN}}$	VFB Voltage Line Regulation	V _{IN} = 2.2 V to 5.5 V		3		mV
$\frac{\Delta V_{FB}}{\Delta T_{opt}}$	VFB Voltage Temperature Coefficient	-40°C ≤ Topt ≤ 85°C		±150		ppm/°C
I _{FB}	VFB Input Current	V _{IN} = 5.5 V, V _{FB} = 0 V or 5.5 V	-0.1		0.1	μA
A _v	Open Loop Voltage Gain	V _{IN} = 3.3 V		100		dB
f _T	Unity Gain Frequency Band	V _{IN} = 3.3 V, A _v = 0		1.0		MHz
f _{osc}	Oscillator Frequency	V _{IN} = 3.3 V, V _{DLY} = V _{FB} = 0 V	595	700	805	kHz
$\frac{\Delta f_{osc}}{\Delta V_{IN}}$	Oscillator Frequency Line Regulation	V _{IN} = 2.2 V to 5.5 V		50		kHz
$\frac{\Delta f_{osc}}{\Delta T_{opt}}$	Oscillator Frequency Temperature Coefficient	-40°C ≤ Topt ≤ 85°C		±1.0		kHz/°C
I _{DD1}	Supply Current 1	V _{IN} = 5.5 V, V _{DLY} = V _{FB} = 0 V, EXT at no load		600	1000	μA
V _{REFOUT}	VREFOUT Voltage	V _{IN} = 3.3 V, I _{ROUT} = 1 mA	1.478	1.500	1.522	V
I _{OUT}	VREFOUT Maximum Output Current	V _{IN} = 3.3 V	10			mA
$\frac{\Delta V_{REFOUT}}{\Delta V_{IN}}$	VREFOUT Line Regulation	V _{IN} = 2.2 V to 5.5 V		5	10	mV
$\frac{\Delta V_{REFOUT}}{\Delta I_{ROUT}}$	VREFOUT Load Regulation	V _{IN} = 3.3 V, I _{ROUT} = 0.1 mA to 5 mA		6	15	mV
I _{lim}	VREFOUT Short Current Limit	V _{IN} = 3.3 V, V _{REFOUT} = 0 V		20		mA
$\frac{\Delta V_{REFOUT}}{\Delta T_{opt}}$	VREFOUT Voltage Temperature Coefficient	-40°C ≤ Topt ≤ 85°C		±150		ppm/°C
R _{EXTH}	EXT "H" ON Resistance	V _{IN} = 3.3 V, I _{EXT} = -50 mA		2.5	6.0	Ω
R _{EXTL}	EXT "L" ON Resistance	V _{IN} = 3.3 V, I _{EXT} = 50 mA		1.5	4.0	Ω
t _r	EXT Rising Time	V _{IN} = 3.3 V, C _L = 1000 pF		12		ns
t _f	EXT Falling Time	V _{IN} = 3.3 V, C _L = 1000 pF		8		ns
I _{DLY1}	DELAY Pin Charge Current	V _{IN} = 3.3 V, V _{DLY} = 0 V, V _{FB} = 0 V	3.0	5.5	8.0	μA
I _{DLY2}	DELAY Pin Discharge Current	V _{IN} = V _{FB} = 2.2 V, V _{DLY} = 0.1 V	0.08	0.20	0.36	mA
V _{DLY}	DELAY Pin Detector Threshold	V _{IN} = 3.3 V, V _{FB} = 0 V, V _{DLY} = 0 V → 2 V	0.95	1.00	1.05	V
V _{UVLO1}	UVLO Detector Threshold	V _{IN} = 3.3 V → 0 V, V _{DLY} = V _{FB} = 0 V	1.8	1.9	2.0	V
V _{UVLO2}	UVLO Released Voltage	V _{IN} = 0 V → 3.3 V, V _{DLY} = V _{FB} = 0 V		V _{UVLO1} + 0.2	2.2	V
V _{DTC0}	Duty = 0% DTC Pin Voltage	V _{IN} = 3.3 V	0.05	0.18	0.25	V
V _{DTC20}	Duty = 20% DTC Pin Voltage	V _{IN} = 3.3 V		0.3		V
V _{DTC80}	Duty = 80% DTC Pin Voltage	V _{IN} = 3.3 V		0.75		V
V _{DTC100}	Duty = 100% DTC Pin Voltage	V _{IN} = 3.3 V	0.80	0.87	1.00	V
I _{AMPH}	AMP "H" Output Current	V _{IN} = 3.3 V, V _{AMP} = 1.0 V, V _{FB} = 0.9 V	0.5	1.0	1.8	mA
I _{AMPL}	AMP "L" Output Current	V _{IN} = 3.3 V, V _{AMP} = 1.0 V, V _{FB} = 1.1 V	60	100	160	μA

R1212D100B Electrical Characteristics

(Topt = 25°C)

Symbol	Item	Conditions	Min.	Typ.	Max.	Unit
V _{IN}	Operating Input Voltage		2.2		5.5	V
V _{FB}	VFB Voltage Tolerance	V _{IN} = 3.3 V	0.985	1.000	1.015	V
$\frac{\Delta V_{FB}}{\Delta V_{IN}}$	VFB Voltage Line Regulation	V _{IN} = 2.2 V to 5.5 V		3		mV
$\frac{\Delta V_{FB}}{\Delta T_{opt}}$	VFB Voltage Temperature Coefficient	-40°C ≤ Topt ≤ 85°C		±150		ppm/°C
I _{FB}	VFB Input Current	V _{IN} = 5.5 V, V _{FB} = 0 V or 5.5 V	-0.1		0.1	μA
A _v	Open Loop Voltage Gain	V _{IN} = 3.3 V		100		dB
f _T	Unity Gain Frequency Band	V _{IN} = 3.3 V, A _v = 0		1.0		MHz
f _{osc}	Oscillator Frequency	V _{IN} = 3.3 V, V _{DLY} = V _{FB} = 0 V	1.19	1.40	1.61	MHz
$\frac{\Delta f_{osc}}{\Delta V_{IN}}$	Oscillator Frequency Line Regulation	V _{IN} = 2.2 V to 5.5 V		100		kHz
$\frac{\Delta f_{osc}}{\Delta T_{opt}}$	Oscillator Frequency Temperature Coefficient	-40°C ≤ Topt ≤ 85°C		±2.0		kHz/°C
I _{DD1}	Supply Current 1	V _{IN} = 5.5 V, V _{DLY} = V _{FB} = 0 V EXT at no load		900	1800	μA
V _{REFOUT}	VREFOUT Voltage	V _{IN} = 3.3 V, I _{ROUT} = 1 mA	1.478	1.500	1.522	V
I _{OUT}	VREFOUT Maximum Output Current	V _{IN} = 3.3 V	10			mA
$\frac{\Delta V_{REFOUT}}{\Delta V_{IN}}$	VREFOUT Line Regulation	V _{IN} = 2.2 V to 5.5 V		5	10	mV
$\frac{\Delta V_{REFOUT}}{\Delta I_{ROUT}}$	VREFOUT Load Regulation	V _{IN} = 3.3 V, I _{ROUT} = 0.1 mA to 5 mA		6	15	mV
I _{lim}	VREFOUT Short Current Limit	V _{IN} = 3.3 V, V _{REFOUT} = 0 V		20		mA
$\frac{\Delta V_{REFOUT}}{\Delta T_{opt}}$	VREFOUT Voltage Temperature Coefficient	-40°C ≤ Topt ≤ 85°C		±150		ppm/°C
R _{EXTH}	EXT "H" ON Resistance	V _{IN} = 3.3 V, I _{EXT} = -50 mA		2.5	6.0	Ω
R _{EXTL}	EXT "L" ON Resistance	V _{IN} = 3.3 V, I _{EXT} = 50 mA		1.5	4.0	Ω
t _r	EXT Rising Time	V _{IN} = 3.3 V, C _L = 1000 pF		12		ns
t _f	EXT Falling Time	V _{IN} = 3.3 V, C _L = 1000 pF		8		ns
I _{DLY1}	DELAY Pin Charge Current	V _{IN} = 3.3 V, V _{DLY} = V _{FB} = 0 V	3.0	5.5	8.0	μA
I _{DLY2}	DELAY Pin Discharge Current	V _{IN} = V _{FB} = 2.2 V, V _{DLY} = 0.1 V	0.08	0.20	0.36	mA
V _{DLY}	DELAY Pin Detector Threshold	V _{IN} = 3.3 V, V _{FB} = 0 V, V _{DLY} = 0 V → 2 V	0.95	1.00	1.05	V
V _{UVLO1}	UVLO Detector Threshold	V _{IN} = 3.3 V → 0 V, V _{DLY} = V _{FB} = 0 V	1.8	1.9	2.0	V
V _{UVLO2}	UVLO Released Voltage	V _{IN} = 0 V → 3.3 V, V _{DLY} = V _{FB} = 0 V		V _{UVLO1} +0.2	2.2	V
V _{DTC0}	Duty = 0% DTC Pin Voltage	V _{IN} = 3.3 V	0.05	0.18	0.25	V
V _{DTC20}	Duty = 20% DTC Pin Voltage	V _{IN} = 3.3 V		0.3		V
V _{DTC80}	Duty = 80% DTC Pin Voltage	V _{IN} = 3.3 V		0.75		V
V _{DTC100}	Duty = 100% DTC Pin Voltage	V _{IN} = 3.3 V	0.80	0.87	1.00	V
I _{AMPH}	AMP "H" Output Current	V _{IN} = 3.3 V, V _{AMP} = 1.0 V, V _{FB} = 0.9 V	0.5	1.0	1.8	mA
I _{AMPL}	AMP "L" Output Current	V _{IN} = 3.3 V, V _{AMP} = 1.0 V, V _{FB} = 1.1 V	60	100	160	μA

R1212D

NO.EA-109-160115

R1212D101A Electrical Characteristics(T_{opt} = 25°C)

Symbol	Item	Conditions	Min.	Typ.	Max.	Unit
V _{IN}	Operating Input Voltage		2.5		5.5	V
V _{FB}	VFB Voltage Tolerance	V _{IN} = 3.3 V	0.985	1.000	1.015	V
$\frac{\Delta V_{FB}}{\Delta V_{IN}}$	VFB Voltage Line Regulation	V _{IN} = 2.5 V to 5.5 V		3		mV
$\frac{\Delta V_{FB}}{\Delta T_{opt}}$	VFB Voltage Temperature Coefficient	-40°C ≤ T _{opt} ≤ 85°C		±150		ppm/°C
I _{FB}	VFB Input Current	V _{IN} = 5.5 V, V _{FB} = 0 V or 5.5 V	-0.1		0.1	μA
A _v	Open Loop Voltage Gain	V _{IN} = 3.3 V		100		dB
f _r	Unity Gain Frequency Band	V _{IN} = 3.3 V, A _v = 0		1.0		MHz
f _{osc}	Oscillator Frequency	V _{IN} = 3.3 V, V _{DLY} = V _{FB} = 0 V	595	700	805	kHz
$\frac{\Delta f_{osc}}{\Delta V_{IN}}$	Oscillator Frequency Line Regulation	V _{IN} = 2.5 V to 5.5 V		50		kHz
$\frac{\Delta f_{osc}}{\Delta T_{opt}}$	Oscillator Frequency Temperature Coefficient	-40°C ≤ T _{opt} ≤ 85°C		±1.0		kHz/°C
I _{DD1}	Supply Current 1	V _{IN} = 5.5 V, V _{DLY} = V _{FB} = 0 V, EXT at no load		600	1000	μA
V _{REFOUT}	VREFOUT Voltage	V _{IN} = 3.3 V, I _{ROUT} = 1 mA	1.478	1.500	1.522	V
I _{OUT}	VREFOUT Maximum Output Current	V _{IN} = 3.3 V	10			mA
$\frac{\Delta V_{REFOUT}}{\Delta V_{IN}}$	VREFOUT Line Regulation	V _{IN} = 2.5 V to 5.5 V		5	10	mV
$\frac{\Delta V_{REFOUT}}{\Delta I_{ROUT}}$	VREFOUT Load Regulation	V _{IN} = 3.3 V, I _{ROUT} = 0.1 mA ~ 5 mA		6	15	mV
I _{lim}	VREFOUT Short Current Limit	V _{IN} = 3.3 V, V _{REFOUT} = 0 V		20		mA
$\frac{\Delta V_{REFOUT}}{\Delta T_{opt}}$	VREFOUT Voltage Temperature Coefficient	-40°C ≤ T _{opt} ≤ 85°C		±150		ppm/°C
R _{EXTH}	EXT "H" ON Resistance	V _{IN} = 3.3 V, I _{EXT} = -50 mA		2.5	6.0	Ω
R _{EXTL}	EXT "L" ON Resistance	V _{IN} = 3.3 V, I _{EXT} = 50 mA		1.5	4.0	Ω
t _r	EXT Rising Time	V _{IN} = 3.3 V, C _L = 1000 pF		12		ns
t _f	EXT Falling Time	V _{IN} = 3.3 V, C _L = 1000 pF		8		ns
I _{DLY1}	DELAY Pin Charge Current	V _{IN} = 3.3 V, V _{DLY} = 0 V, V _{FB} = 0 V	3.0	5.5	8.0	μA
I _{DLY2}	DELAY Pin Discharge Current	V _{IN} = V _{FB} = 2.5 V, V _{DLY} = 0.1 V	0.08	0.20	0.36	mA
V _{DLY}	DELAY Pin Detector Threshold	V _{IN} = 3.3 V, V _{FB} = 0 V, V _{DLY} = 0 V → 2 V	0.95	1.00	1.05	V
V _{UVLO1}	UVLO Detector Threshold	V _{IN} = 3.3 V → 0 V, V _{DLY} = V _{FB} = 0 V	2.0	2.1	2.2	V
V _{UVLO2}	UVLO Released Voltage	V _{IN} = 0 V → 3.3 V, V _{DLY} = V _{FB} = 0 V		V _{UVLO1} +0.2	2.45	V
V _{DTC0}	Duty□0% DTC Pin Voltage	V _{IN} = 3.3 V	0.05	0.18	0.25	V
V _{DTC20}	Duty□20% DTC Pin Voltage	V _{IN} = 3.3 V		0.3		V
V _{DTC80}	Duty□80% DTC Pin Voltage	V _{IN} = 3.3 V		0.75		V
Maxduty	Maximum Duty Cycle	V _{IN} = 3.3 V	84	90	96	%
I _{AMPH}	AMP "H" Output Current	V _{IN} = 3.3 V, V _{AMP} = 1.0 V, V _{FB} = 0.9 V	0.5	1.0	1.8	mA
I _{AMPL}	AMP "L" Output Current	V _{IN} = 3.3 V, V _{AMP} = 1.0 V, V _{FB} = 1.1 V	60	100	160	μA

R1212D101C Electrical Characteristics

(T_{opt} = 25°C)

Symbol	Item	Conditions	Min.	Typ.	Max.	Unit
V _{IN}	Operating Input Voltage		2.5		5.5	V
V _{FB}	VFB Voltage Tolerance	V _{IN} = 3.3 V	0.985	1.000	1.015	V
$\frac{\Delta V_{FB}}{\Delta V_{IN}}$	VFB Voltage Line Regulation	V _{IN} = 2.5 V to 5.5 V		3		mV
$\frac{\Delta V_{FB}}{\Delta T_{opt}}$	VFB Voltage Temperature Coefficient	-40°C ≤ T _{opt} ≤ 85°C		±150		ppm/°C
I _{FB}	VFB Input Current	V _{IN} = 5.5 V, V _{FB} = 0 V or 5.5 V	-0.1		0.1	μA
A _v	Open Loop Voltage Gain	V _{IN} = 3.3 V		100		dB
f _T	Unity Gain Frequency Band	V _{IN} = 3.3 V, A _v = 0		1.0		MHz
f _{osc}	Oscillator Frequency	V _{IN} = 3.3 V, V _{DLY} = V _{FB} = 0 V	240	300	360	kHz
$\frac{\Delta f_{osc}}{\Delta V_{IN}}$	Oscillator Frequency Line Regulation	V _{IN} = 2.5 V to 5.5 V		25		kHz
$\frac{\Delta f_{osc}}{\Delta T_{opt}}$	Oscillator Frequency Temperature Coefficient	-40°C ≤ T _{opt} ≤ 85°C		±0.5		kHz/°C
I _{DD1}	Supply Current 1	V _{IN} = 5.5 V, V _{DLY} = V _{FB} = 0 V, EXT at no load		400	800	μA
V _{REFOUT}	VREFOUT Voltage	V _{IN} = 3.3 V, I _{ROUT} = 1 mA	1.478	1.500	1.522	V
I _{OUT}	VREFOUT Maximum Output Current	V _{IN} = 3.3 V	10			mA
$\frac{\Delta V_{REFOUT}}{\Delta V_{IN}}$	VREFOUT Line Regulation	V _{IN} = 2.5 V to 5.5 V		5	10	mV
$\frac{\Delta V_{REFOUT}}{\Delta I_{ROUT}}$	VREFOUT Load Regulation	V _{IN} = 3.3 V, I _{ROUT} = 0.1 mA to 5 mA		6	15	mV
I _{lim}	VREFOUT Short Current Limit	V _{IN} = 3.3 V, V _{REFOUT} = 0 V		20		mA
$\frac{\Delta V_{REFOUT}}{\Delta T_{opt}}$	VREFOUT Voltage Temperature Coefficient	-40°C ≤ T _{opt} ≤ 85°C		±150		ppm/°C
R _{EXTH}	EXT "H" ON Resistance	V _{IN} = 3.3 V, I _{EXT} = -50 mA		2.5	6.0	Ω
R _{EXTL}	EXT "L" ON Resistance	V _{IN} = 3.3 V, I _{EXT} = 50 mA		1.5	4.0	Ω
t _r	EXT Rising Time	V _{IN} = 3.3 V, C _L = 1000 pF		12		ns
t _f	EXT Falling Time	V _{IN} = 3.3 V, C _L = 1000 pF		8		ns
I _{DLY1}	DELAY Pin Charge Current	V _{IN} = 3.3 V, V _{DLY} = 0 V, V _{FB} = 0 V	2.0	4.5	7.0	μA
I _{DLY2}	DELAY Pin Discharge Current	V _{IN} = V _{FB} = 2.5 V, V _{DLY} = 0.1 V	0.08	0.20	0.36	mA
V _{DLY}	DELAY Pin Detector Threshold	V _{IN} = 3.3 V, V _{FB} = 0 V, V _{DLY} = 0 V → 2 V	0.95	1.00	1.05	V
V _{UVLO1}	UVLO Detector Threshold	V _{IN} = 3.3 V → 0 V, V _{DLY} = V _{FB} = 0 V	2.0	2.1	2.2	V
V _{UVLO2}	UVLO Released Voltage	V _{IN} = 0 V → 3.3 V, V _{DLY} = V _{FB} = 0 V		V _{UVLO1} +0.2	2.45	V
V _{DTC0}	Duty = 0% DTC Pin Voltage	V _{IN} = 3.3 V	0.05	0.18	0.25	V
V _{DTC20}	Duty = 20% DTC Pin Voltage	V _{IN} = 3.3 V		0.3		V
V _{DTC80}	Duty = 80% DTC Pin Voltage	V _{IN} = 3.3 V		0.75		V
Maxduty	Maximum Duty Cycle	V _{IN} = 3.3 V	85.5	91.5	97.5	%
I _{AMPH}	AMP "H" Output Current	V _{IN} = 3.3 V, V _{AMP} = 1.0 V, V _{FB} = 0.9 V	0.5	1.0	1.8	mA
I _{AMPL}	AMP "L" Output Current	V _{IN} = 3.3 V, V _{AMP} = 1.0 V, V _{FB} = 1.1 V	50	90	150	μA

R1212D

NO.EA-109-160115

R1212D102A Electrical Characteristics(T_{opt} = 25°C)

Symbol	Item	Conditions	Min.	Typ.	Max.	Unit
V _{IN}	Operating Input Voltage		3.3		5.5	V
V _{FB}	VFB Voltage Tolerance	V _{IN} = 3.3 V	0.985	1.000	1.015	V
$\frac{\Delta V_{FB}}{\Delta V_{IN}}$	VFB Voltage Line Regulation	V _{IN} = 3.3 V to 5.5 V		3		mV
$\frac{\Delta V_{FB}}{\Delta T_{opt}}$	VFB Voltage Temperature Coefficient	-40°C ≤ T _{opt} ≤ 85°C		±150		ppm/°C
I _{FB}	VFB Input Current	V _{IN} = 5.5V, V _{FB} = 0 V or 5.5 V	-0.1		0.1	μA
A _v	Open Loop Voltage Gain	V _{IN} = 3.3 V		100		dB
f _T	Unity Gain Frequency Band	V _{IN} = 3.3 V, A _v = 0		1.0		MHz
f _{osc}	Oscillator Frequency	V _{IN} = 3.3 V, V _{DLY} = V _{FB} = 0 V	595	700	805	kHz
$\frac{\Delta f_{osc}}{\Delta V_{IN}}$	Oscillator Frequency Line Regulation	V _{IN} = 3.3 V to 5.5 V		50		kHz
$\frac{\Delta f_{osc}}{\Delta T_{opt}}$	Oscillator Frequency Temperature Coefficient	-40°C ≤ T _{opt} ≤ 85°C		±1.0		kHz/°C
I _{DD1}	Supply Current 1	V _{IN} = 5.5 V, V _{DLY} = V _{FB} = 0 V, EXT at no load		600	1000	μA
V _{REFOUT}	VREFOUT Voltage	V _{IN} = 3.3 V, I _{ROUT} = 1 mA	1.478	1.500	1.522	V
I _{OUT}	VREFOUT Maximum Output Current	V _{IN} = 3.3 V	10			mA
$\frac{\Delta V_{REFOUT}}{\Delta V_{IN}}$	VREFOUT Line Regulation	V _{IN} = 3.3 V to 5.5 V		5	10	mV
$\frac{\Delta V_{REFOUT}}{\Delta I_{ROUT}}$	VREFOUT Load Regulation	V _{IN} = 3.3 V, I _{ROUT} = 0.1 mA ~ 5 mA		6	15	mV
I _{lim}	VREFOUT Short Current Limit	V _{IN} = 3.3 V, V _{REFOUT} = 0 V		20		mA
$\frac{\Delta V_{REFOUT}}{\Delta T_{opt}}$	VREFOUT Voltage Temperature Coefficient	-40°C ≤ T _{opt} ≤ 85°C		±150		ppm/°C
R _{EXTH}	EXT "H" ON Resistance	V _{IN} = 3.3 V, I _{EXT} = -50 mA		2.5	6.0	Ω
R _{EXTL}	EXT "L" ON Resistance	V _{IN} = 3.3 V, I _{EXT} = 50 mA		1.5	4.0	Ω
t _r	EXT Rising Time	V _{IN} = 3.3 V, C _L = 1000 pF		12		ns
t _f	EXT Falling Time	V _{IN} = 3.3 V, C _L = 1000 pF		8		ns
I _{DLY1}	DELAY Pin Charge Current	V _{IN} = 3.3 V, V _{DLY} = 0 V, V _{FB} = 0 V	3.0	5.5	8.0	μA
I _{DLY2}	DELAY Pin Discharge Current	V _{IN} = V _{FB} = 3.3 V, V _{DLY} = 0.1 V	0.08	0.20	0.36	mA
V _{DLY}	DELAY Pin Detector Threshold	V _{IN} = 3.3 V, V _{FB} = 0 V, V _{DLY} = 0 V → 2 V	0.95	1.00	1.05	V
V _{UVLO1}	UVLO Detector Threshold	V _{IN} = 3.3 V → 0 V, V _{DLY} = V _{FB} = 0 V	2.6	2.8	3.0	V
V _{UVLO2}	UVLO Released Voltage	V _{IN} = 0 V → 3.3 V, V _{DLY} = V _{FB} = 0 V		V _{UVLO1} +0.25	3.3	V
V _{DTC0}	Duty = 0% DTC Pin Voltage	V _{IN} = 3.3 V	0.05	0.18	0.25	V
V _{DTC20}	Duty = 20% DTC Pin Voltage	V _{IN} = 3.3 V		0.3		V
V _{DTC80}	Duty = 80% DTC Pin Voltage	V _{IN} = 3.3 V		0.75		V
Maxduty	Maximum Duty Cycle	V _{IN} = 3.3 V	84	90	96	%
I _{AMPH}	AMP "H" Output Current	V _{IN} = 3.3 V, V _{AMP} = 1.0 V, V _{FB} = 0.9 V	0.5	1.0	1.8	mA
I _{AMPL}	AMP "L" Output Current	V _{IN} = 3.3 V, V _{AMP} = 1.0 V, V _{FB} = 1.1 V	60	100	160	μA

R1212D102C Electrical Characteristics

(T_{opt} = 25°C)

Symbol	Item	Conditions	Min.	Typ.	Max.	Unit
V _{IN}	Operating Input Voltage		3.3		5.5	V
V _{FB}	VFB Voltage Tolerance	V _{IN} = 3.3 V	0.985	1.000	1.015	V
$\frac{\Delta V_{FB}}{\Delta V_{IN}}$	VFB Voltage Line Regulation	V _{IN} = 3.3 V to 5.5 V		3		mV
$\frac{\Delta V_{FB}}{\Delta T_{opt}}$	VFB Voltage Temperature Coefficient	-40°C ≤ T _{opt} ≤ 85°C		±150		ppm/°C
I _{FB}	VFB Input Current	V _{IN} = 5.5 V, V _{FB} = 0 V or 5.5 V	-0.1		0.1	μA
A _v	Open Loop Voltage Gain	V _{IN} = 3.3 V		100		dB
f _T	Unity Gain Frequency Band	V _{IN} = 3.3 V, A _v = 0		1.0		MHz
f _{osc}	Oscillator Frequency	V _{IN} = 3.3 V, V _{DLY} = V _{FB} = 0 V	240	300	360	kHz
$\frac{\Delta f_{osc}}{\Delta V_{IN}}$	Oscillator Frequency Line Regulation	V _{IN} = 3.3 V to 5.5 V		25		kHz
$\frac{\Delta f_{osc}}{\Delta T_{opt}}$	Oscillator Frequency Temperature Coefficient	-40°C ≤ T _{opt} ≤ 85°C		±0.5		kHz/°C
I _{DD1}	Supply Current 1	V _{IN} = 5.5 V, V _{DLY} = V _{FB} = 0 V, EXT at noload		400	800	μA
V _{REFOUT}	VREFOUT Voltage	V _{IN} = 3.3 V, I _{ROUT} = 1 mA	1.478	1.500	1.522	V
I _{OUT}	VREFOUT Maximum Output Current	V _{IN} = 3.3 V	10			mA
$\frac{\Delta V_{REFOUT}}{\Delta V_{IN}}$	VREFOUT Line Regulation	V _{IN} = 3.3 V to 5.5 V		5	10	mV
$\frac{\Delta V_{REFOUT}}{\Delta I_{ROUT}}$	VREFOUT Load Regulation	V _{IN} = 3.3 V, I _{ROUT} = 0.1 mA ~ 5 mA		6	15	mV
I _{lim}	VREFOUT Short Current Limit	V _{IN} = 3.3 V, V _{REFOUT} = 0 V		20		mA
$\frac{\Delta V_{REFOUT}}{\Delta T_{opt}}$	VREFOUT Voltage Temperature Coefficient	-40°C ≤ T _{opt} ≤ 85°C		±150		ppm/°C
R _{EXTH}	EXT "H" ON Resistance	V _{IN} = 3.3 V, I _{EXT} = -50 mA		2.5	6.0	Ω
R _{EXTL}	EXT "L" ON Resistance	V _{IN} = 3.3 V, I _{EXT} = 50 mA		1.5	4.0	Ω
t _r	EXT Rising Time	V _{IN} = 3.3 V, C _L = 1000 pF		12		ns
t _f	EXT Falling Time	V _{IN} = 3.3 V, C _L = 1000 pF		8		ns
I _{DLY1}	DELAY Pin Charge Current	V _{IN} = 3.3 V, V _{DLY} = 0 V, V _{FB} = 0 V	2.0	4.5	7.0	μA
I _{DLY2}	DELAY Pin Discharge Current	V _{IN} = V _{FB} = 3.3 V, V _{DLY} = 0.1 V	0.08	0.20	0.36	mA
V _{DLY}	DELAY Pin Detector Threshold	V _{IN} = 3.3 V, V _{FB} = 0 V, V _{DLY} = 0 V → 2 V	0.95	1.00	1.05	V
V _{UVLO1}	UVLO Detector Threshold	V _{IN} = 3.3 V → 0 V, V _{DLY} = V _{FB} = 0 V	2.6	2.8	3.0	V
V _{UVLO2}	UVLO Released Voltage	V _{IN} = 0 V → 3.3 V, V _{DLY} = V _{FB} = 0 V		V _{UVLO1} +0.25	3.30	V
V _{DTC0}	Duty = 0% DTC Pin Voltage	V _{IN} = 3.3 V	0.05	0.18	0.25	V
V _{DTC20}	Duty = 20% DTC Pin Voltage	V _{IN} = 3.3 V		0.3		V
V _{DTC80}	Duty = 80% DTC Pin Voltage	V _{IN} = 3.3 V		0.75		V
Maxduty	Maximum Duty Cycle	V _{IN} = 3.3 V	85.5	91.5	97.5	%
I _{AMPH}	AMP "H" Output Current	V _{IN} = 3.3 V, V _{AMP} = 1.0 V, V _{FB} = 0.9 V	0.5	1.0	1.8	mA
I _{AMPL}	AMP "L" Output Current	V _{IN} = 3.3 V, V _{AMP} = 1.0 V, V _{FB} = 1.1 V	50	90	150	μA

R1212D

NO.EA-109-160115

TYPICAL APPLICATIONS AND TECHNICAL NOTES

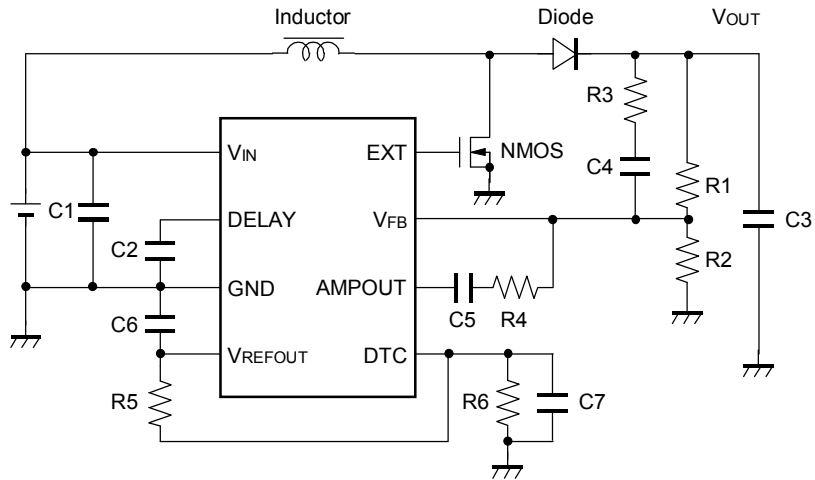

R1212D Typical Application

Inductor	VLF504012MT-100M (TDK: 10 μ H) [R1212DxxxA]
	VLF504012MT-4R7M (TDK: 4.7 μ H) [R1212DxxxB]
	VLF504012MT-220M (TDK: 22 μ H) [R1212DxxxC]
NMOS	CPH6415 (Sanyo)
Diode	CRS10I30A (Toshiba)

C1	2.2 μ F	Set V_{OUT}	5 V	10 V	15 V
C2	1 μ F	R1	120 k Ω	180 k Ω	140 k Ω
C3	1.5 μ F	R2	30 k Ω	20 k Ω	10 k Ω
C4	1000 pF [R1212DxxxA]	R3	1 k Ω		
	680 pF [R1212DxxxB]	R4	4.7 k Ω		
	1500 pF [R1212DxxxC]	R5	240 k Ω		
C5	1000 pF [R1212DxxxA]	R6	300 k Ω		
	680 pF [R1212DxxxB]				
	1500 pF [R1212DxxxC]				
C6	0.1 μ F				
C7	0.1 μ F				

- Use a 1 μF or more capacitance value of bypass capacitor between VIN pin and GND, C1 as shown in the typical application above. Connect the capacitor as short as possible to the IC.
- In terms of the capacitor for setting delay time of the latch protection, C2 is shown in typical application above. Latch delay time depends on this C2 value. Refer to the Latch Protection Operation Timing Chart.
- Connect a 1 μF or more value of capacitor between VOUT and GND, C3 as shown in typical application above. (Recommended value is from 10 μF to 22 μF .) If the operation of the composed DC/DC converter may be unstable, use a tantalum type capacitor instead of ceramic type
- Connect a capacitor between VREFOUT and GND, C6 as shown in typical application of the previous page. The capacitance value of C6 is between 0.1 μF and 1.0 μF .
- Output Voltage Setting Method and Phase Compensation Making Method
The feedback voltage is controlled into 1.0 V. The output voltage can be set with divider resistors for voltage setting, R1 and R2 as shown in typical application of the previous page. Refer to the next formula.

$$\text{Output Voltage} = V_{\text{FB}} \times (R1 + R2) / R2$$

Output Voltage is adjustable with setting various resistor values combination. R1 + R2 should be equal or less than 500 k Ω

As for the DC/DC converter, depending on the load current and external components such as L and C, phase may loss around 180°. In such case, phase margin becomes less and may be unstable. To avoid this situation, make the phase margin more.

The pole is made with external components L and C.

$$F_{\text{pole}} \sim 1 / \{2 \times \pi \times \sqrt{L \times C3}\}$$

C4, C5, R3, and R4 shown in the diagram are for making phase compensation. The gain of the system can be set with using these resistors and capacitors. Each value in the diagram is just an example. R4 and C5 make zero (the backward phase).

$$F_{\text{zero}} \sim 1 / (2 \times \pi \times R4 \times C5)$$

Choose the R4 and C5 value so as to make the cutoff frequency of this zero point close to the cutoff frequency of the pole by external components, L and C.

For example, supposed that L = 10 μH and C_{OUT} (C3) = 10 μF , the cutoff frequency of the pole is approximately 16 kHz. Therefore make the cutoff frequency of the zero point close to 16 kHz. Then R4 = 4.7 k Ω and C5 = 1000 pF are appropriate values.

R1212D

NO.EA-109-160115

As for setting the gain, the ratio of the composite resistor (R_T : $R_T = R_1 \times R_2 / (R_1 + R_2)$) to R_4 is the key. If the R_4 against the composite resistor, R_T , is large, the gain becomes also large. If the gain is large, the response characteristic is improved, however, too large gain makes the system be unstable.

If the spike noise of V_{OUT} may be large, the spike noise may be picked into V_{FB} pin, and the unstable operation may result. In this case, a resistor R_3 , shown in typical application of the previous page. The recommended resistance value of R_3 is in the range from $1\text{ k}\Omega$ to $5\text{ k}\Omega$. Then, noise level will be decreased.

Further, R_1 and C_4 makes another zero point (the backward phase).

$$F_{\text{zero}} \sim 1 / (2 \times \pi \times R_1 \times C_4)$$

Make the cutoff frequency of this zero point be lower than the cutoff frequency of the pole by external components, or, L and C . Herein, $R_1 = 180\text{ k}\Omega$ and $C_4 = 1000\text{ pF}$ are appropriate values.

- Select the Power MOSFET, the diode, capacitors and the inductor within ratings (Voltage, Current, Power) of this IC. Choose the power MOSFET with low threshold voltage depending on the input voltage to be able to turn on the FET completely. Choose the diode with low V_F such as Schottky type with low reverse current I_R , and with fast switching speed. When an external transistor is switching, spike voltage may be generated caused by an inductor, therefore recommended voltage tolerance of capacitor connected to V_{OUT} is twice as much as the setting voltage or more.
- The soft-start time and the maximum duty cycle setting method
The soft-start time and the maximum duty cycle can be set with R_5 , R_6 , and C_7 values connected to the V_{REFOUT} pin and the DTC pin. (Refer to the timing chart: Soft-start operation.)

OUTPUT CURRENT AND SELECTION OF EXTERNAL COMPONENTS

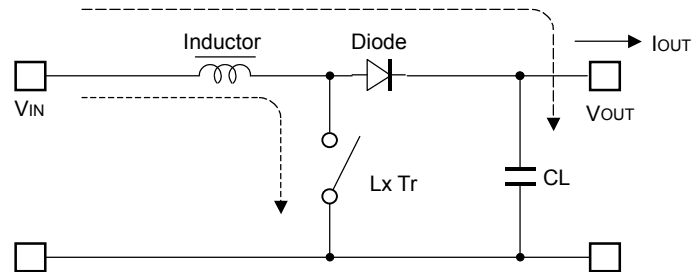

R1212D Typical Application

Current Flowing through L

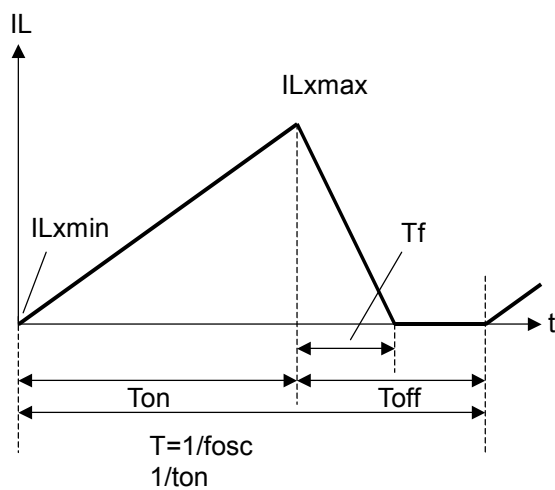

Discontinuous Mode

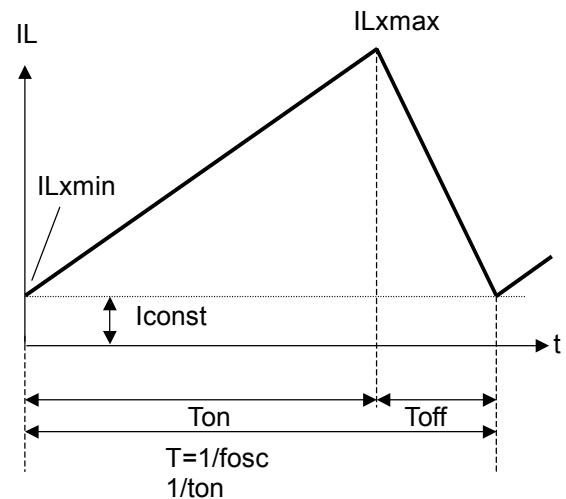

Continuous Mode

There are two modes, or discontinuous mode and continuous mode for the PWM step-up switching regulator depending on the continuous characteristic of inductor current. During on time of the transistor, when the voltage added on to the inductor is described as V_{IN} , the current is $V_{IN} \times t/L$. Therefore, the electric power, P_{ON} , which is supplied with input side, can be described as in next formula.

$$P_{ON} = \int_0^{T_{on}} V_{IN}^2 \times t/L dt \dots\dots\dots \text{Formula 1}$$

With the step-up circuit, electric power is supplied from power source also during off time. In this case, input current is described as $(V_{OUT} - V_{IN}) \times t/L$, therefore electric power, P_{OFF} is described as in next formula.

NO.EA-109-160115

$$P_{OFF} = \int_0^{Tf} V_{IN} \times (V_{OUT} - V_{IN}) \times t/L dt \dots\dots\dots \text{Formula 2}$$

In this formula, Tf means the time of which the energy saved in the inductance is being emitted. Thus average electric power, or P_{AV} is described as in the next formula.

$$P_{AV} = 1/(T_{ON} + T_{OFF}) \times \left\{ \int_0^{T_{on}} V_{IN}^2 \times t/L dt + \int_0^{Tf} V_{IN} \times (V_{OUT} - V_{IN}) \times t/L dt \right\} \dots\dots\dots \text{Formula 3}$$

In PWM control, when Tf = T_{off} is true, the inductor current becomes continuous, then the operation of switching regulator becomes continuous mode. In the continuous mode, the deviation of the current is equal between on time and off time.

$$V_{IN} = T_{ON}/L = (V_{OUT} - V_{IN}) \times T_{OFF} / L \dots\dots\dots \text{Formula 4}$$

Further, the electric power, P_{AV} is equal to output electric power, V_{OUT} × I_{OUT}, thus,

$$I_{OUT} = f_{OSC} \times V_{IN}^2 \times T_{ON}^2 / \{2 \times L \times (V_{OUT} - V_{IN})\} = V_{IN}^2 \times T_{ON} / (2 \times L \times V_{OUT}) \dots\dots\dots \text{Formula 5}$$

When I_{OUT} becomes more than formula 5, the current flows through the inductor, then the mode becomes continuous. The continuous current through the inductor is described as I_{const}, then,

$$I_{OUT} = f_{OSC} \times V_{IN}^2 \times T_{ON}^2 / \{2 \times L \times (V_{OUT} - V_{IN})\} + V_{IN} \times I_{const} / V_{OUT} \dots\dots\dots \text{Formula 6}$$

In this moment, the peak current, I_{Lxmax} flowing through the inductor and the driver Tr. is described as follows:

$$I_{Lx\ max} = I_{const} + V_{IN} \times T_{ON} / L \dots\dots\dots \text{Formula 7}$$

With the formula 4,6, and I_{Lxmax} is,

$$I_{Lx\ max} = V_{OUT} / V_{IN} \times I_{OUT} + V_{IN} \times T_{ON} / (2 \times L) \dots\dots\dots \text{Formula 8}$$

Therefore, peak current is more than I_{OUT}. Considering the value of I_{Lxmax}, the condition of input and output, and external components should be selected.

In the formula 7, peak current I_{Lxmax} at discontinuous mode can be calculated. Put I_{const}=0 in the formula. The explanation above is based on the ideal calculation, and the loss caused by L_x switch and external components is not included. The actual maximum output current is between 50% and 80% of the calculation. Especially, when the I_{Lx} is large, or V_{IN} is low, the loss of V_{IN} is generated with the on resistance of the switch. As for V_{OUT}, Vf (as much as 0.3V) of the diode should be considered.

TIMING CHART

Soft-start Operation

The timing chart below describes the state of each pin from the power-on until the IC entering the stable operation. By raising the voltage of the DTC pin slowly, the switching duty cycle is limited, and prevent the drastic voltage rising (over-shoot) and inrush current.

When the V_{IN} voltage becomes equal or more than the UVLO released voltage ($V_{UVLO}+V_{HYS}$), V_{REFOUT} operation starts. Following with the increase of the voltage level of V_{REFOUT} , the internal oscillator begins to operate, then the DTC voltage is also rising, then, soft-start operation starts. When the DTC voltage crosses the chopping wave level inside the IC, EXT pin starts switching, then, step-up operation begins. During this term, the output voltage does not reach the set output voltage. Therefore the output of the amplifier is "H". Besides, the protection circuit may work and the IC charges the DELAY pin. Because of this, the soft-start time should be set shorter than the latch protection delay time.

After the initial stage, when the output voltage reaches the set output voltage, the level of AMPOUT becomes the normal state. In other words, the level is determined with the input voltage, the output voltage, and the output current. When the level of AMPOUT becomes falling, charging the DELAY pin stops and discharges to the GND. The soft-start time (the time for the DTC pin voltage becoming to V_{DTC} level) can be estimated with the next formula.

$T \cong 1/\alpha \times \ln(V_{DTC} \times \alpha / \beta + 1)$, herein, $\alpha = -1/C7 \times (1/R5 + 1/R6)$, and $\beta = V_{REFOUT} / (C7 \times R5)$.

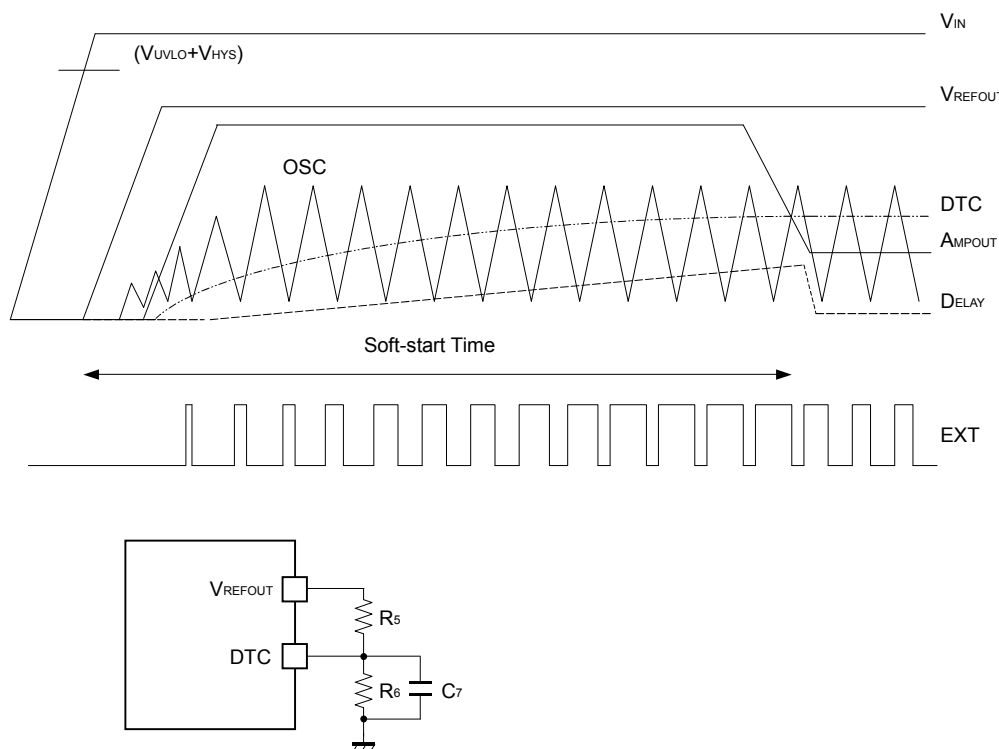

Latch Protection Operation

The operation of Latch protection circuit is as follows: When AMPOUT becomes "H" and the IC detects maximum duty cycle, charge to an external capacitor, C2 of DELAY pin starts. The maximum duty cycle continues and the voltage of DELAY pin reaches delay voltage detector threshold, V_{DLY} , outputs "L" to EXT pin and turns off the external power MOSFET.

To release the latch protection operation, make the supply voltage down to UVLO detector threshold or lower, and make it rise up to the normal input voltage.

Once after becoming the maximum duty cycle, if the duty cycle decreases before latch operation works, the charging the capacitor stops immediately, and the DELAY pin voltage is fixed at GND level with I_{DLY2} .

The delay time of latch protection can be calculated with C2, V_{DLY} , and the delay pin charge current, I_{DLY1} , as in the next formula.

$$t = C2 \times V_{DLY} / I_{DLY1}$$

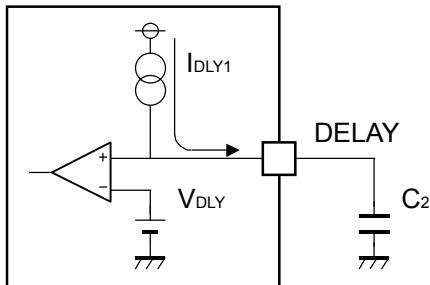
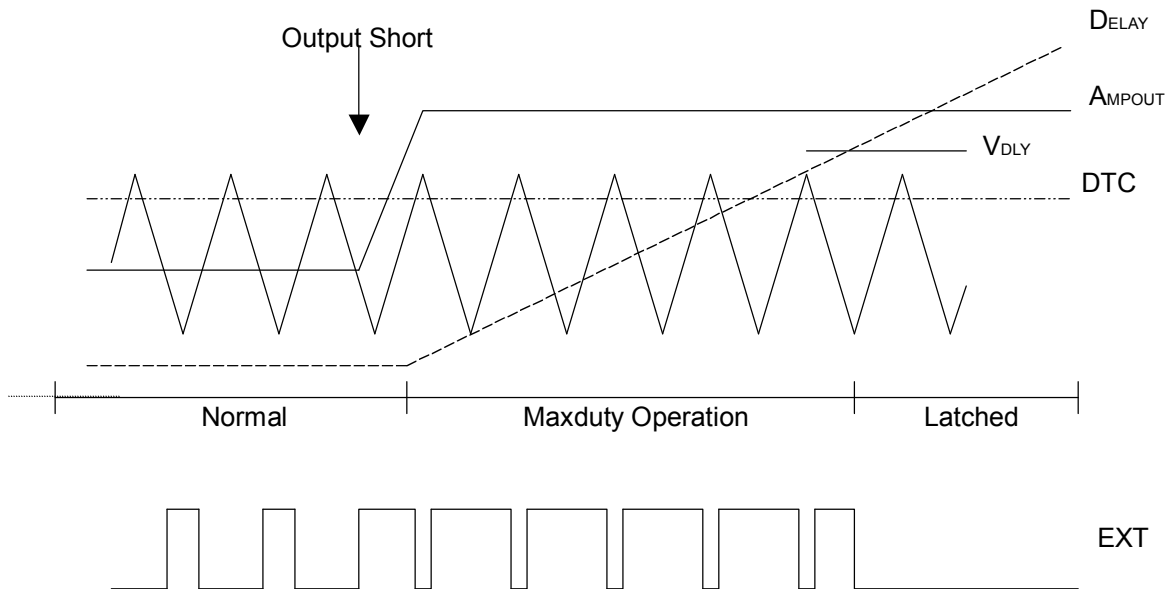

TEST CIRCUITS

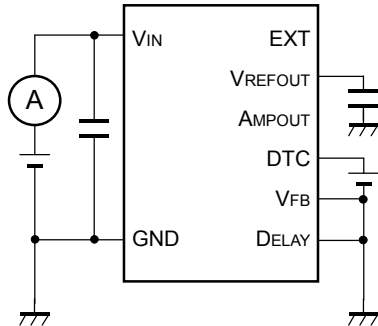

Fig. 1 Consumption Current Test Circuit

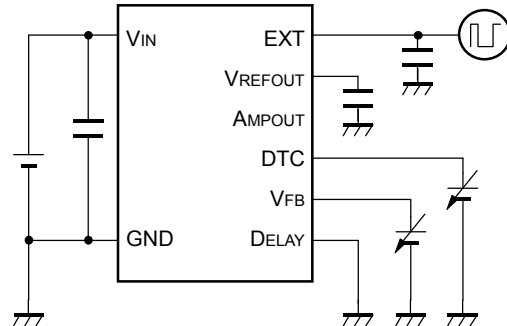

Fig. 2 Oscillator Frequency, V_{FB} Voltage, Duty Cycle, EXT Rising Time/ Falling Time Test Circuit

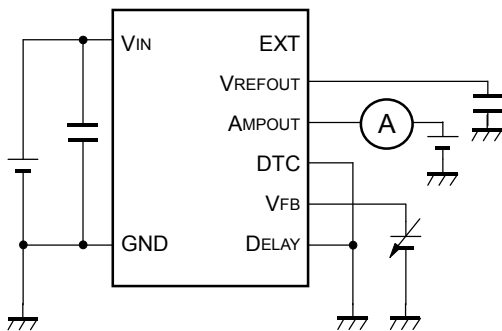

Fig. 3 AMP "L" Output Current/ "H" Output Current Test Circuit

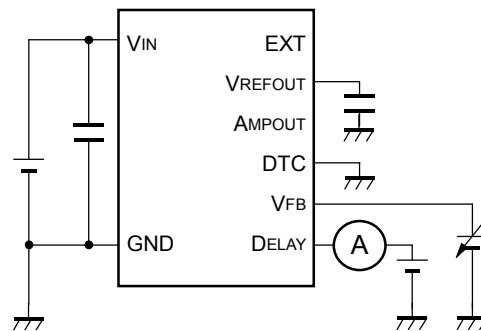

Fig. 4 $DELAY$ Pin Charge Current/ Discharge Current Test Circuit

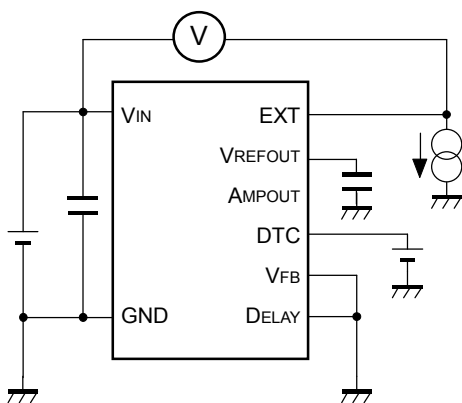

Fig. 5 EXT "H" ON Resistance Test Circuit

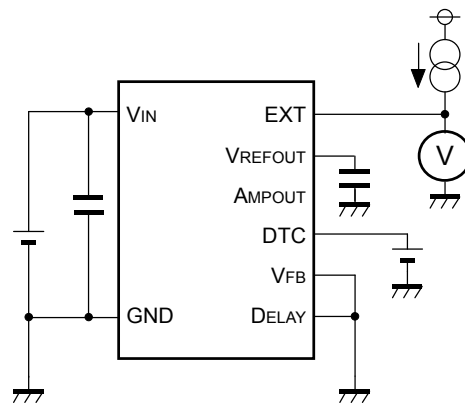

Fig. 6 EXT "L" ON Resistance Test Circuit

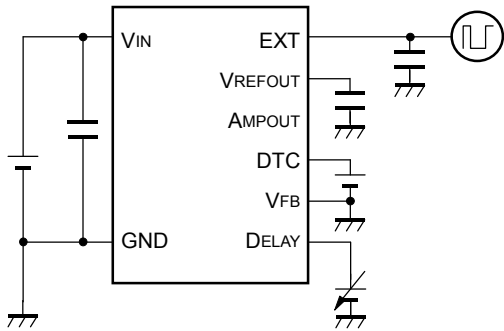

Fig. 7 DELAY Pin Detector Threshold Test Circuit

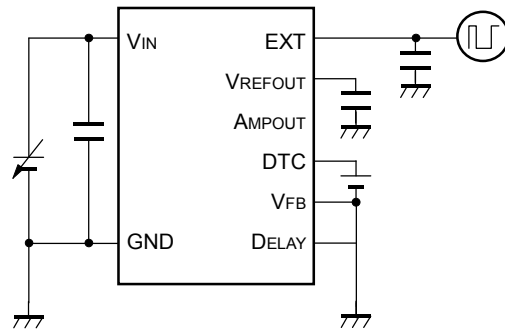

Fig. 8 UVLO Detector Threshold/ Released Voltage Test Circuit

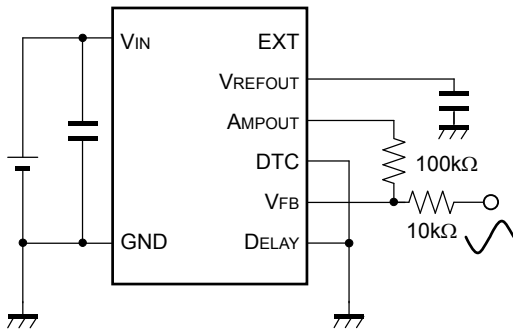

Fig. 9 Error AMP Gain/ Phase Test Circuit

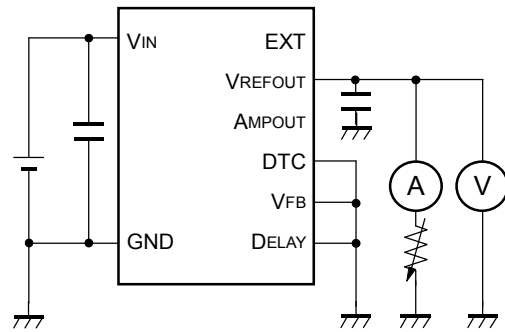

Fig. 10 VREFOUT Voltage Test Current

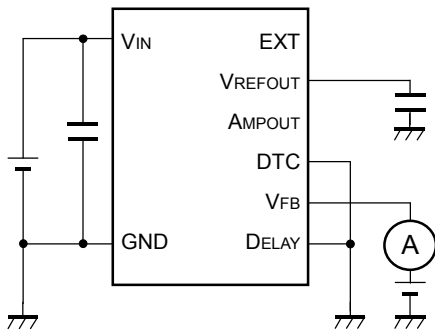

Fig. 11 VFB Leakage Current Test Circuit

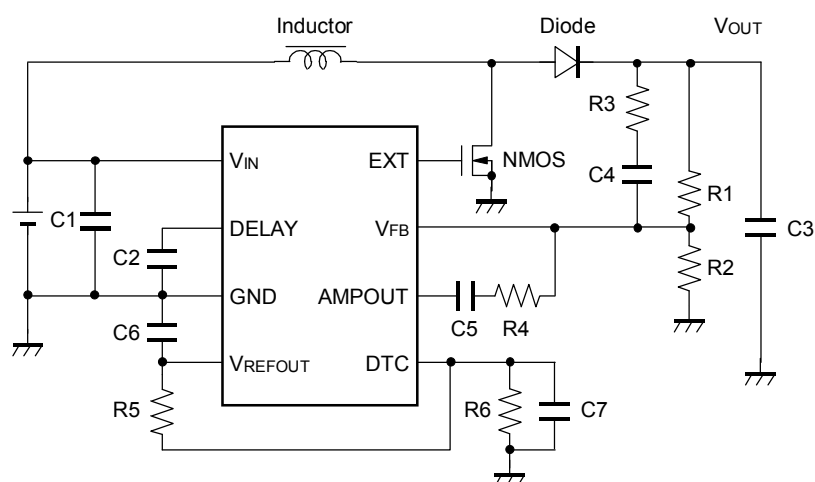

Fig. 12 Output Current vs. Output Voltage/ Efficiency, Response Characteristics Test Circuit

Inductor	VLF504012MT-100M (TDK: 10 μ H) [R1212DxxxA]					
	VLF504012MT-4R7M (TDK: 4.7 μ H) [R1212DxxxB]					
	VLF504012MT-220M (TDK: 22 μ H) [R1212DxxxC]					
NMOS	CPH6415 (Sanyo)					
Diode	CRS10I30A (Toshiba)					
C1	2.2 μ F	C6	0.1 μ F			
C2	1 μ F	C7	0.1 μ F			
C3	15 μ F	SetV	5 V	10 V	15 V	
C4	1000 pF [R1212DxxxA]	R1	120 k Ω	180 k Ω	140 k Ω	
	680 pF [R1212DxxxB]	R2	30 k Ω	20 k Ω	10 k Ω	
	1500 pF [R1212DxxxC]	R3	1 k Ω			
C5	1000 pF [R1212DxxxA]	R4	4.7 k Ω			
	680 pF [R1212DxxxB]	R5	240 k Ω			
	1500 pF [R1212DxxxC]	R6	300 k Ω			

R1212D

NO.EA-109-160115

TYPICAL CHARACTERISTICS

1) Output Voltage vs. Output Current (Topt = 25°C)

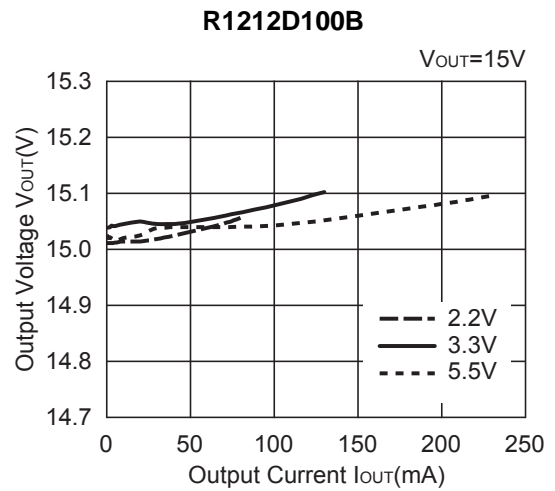
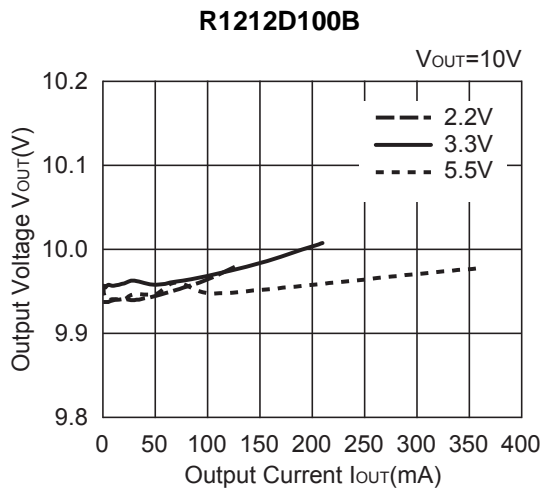
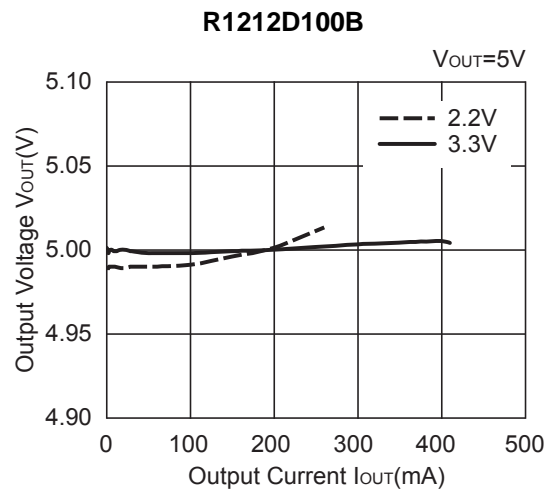
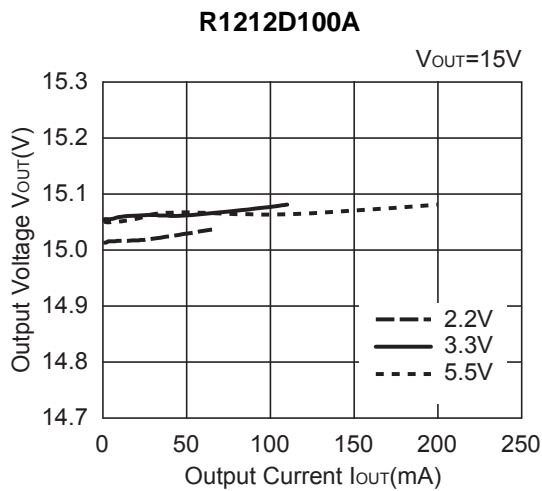
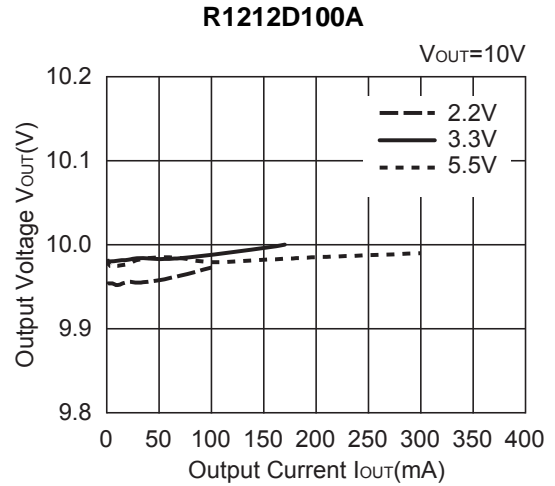
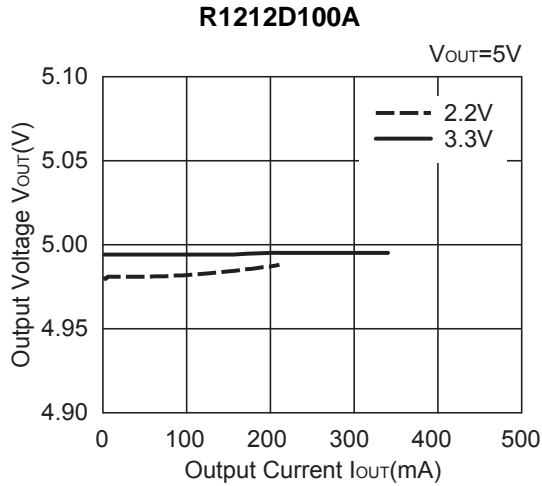

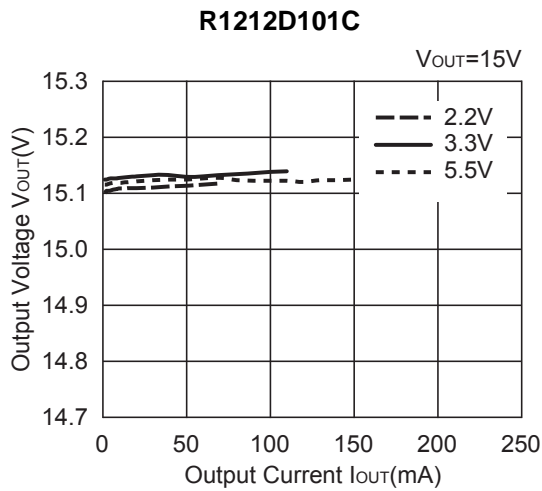
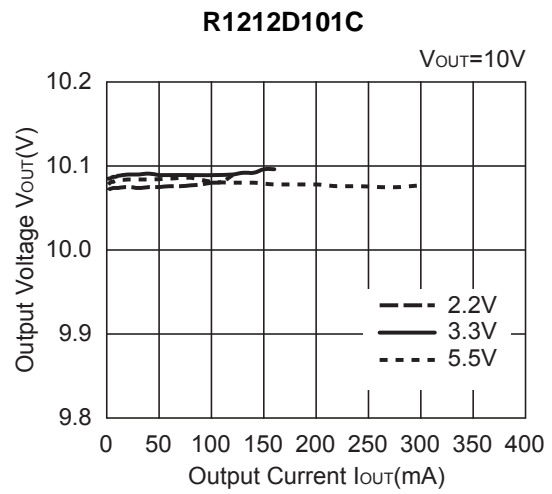
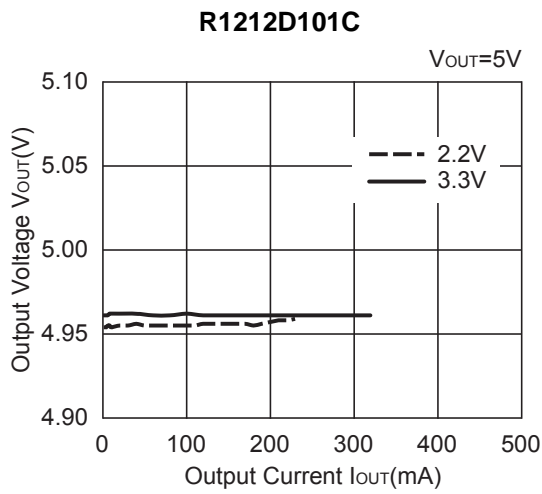

2) Efficiency vs. Output Current ($T_{opt} = 25^{\circ}C$)

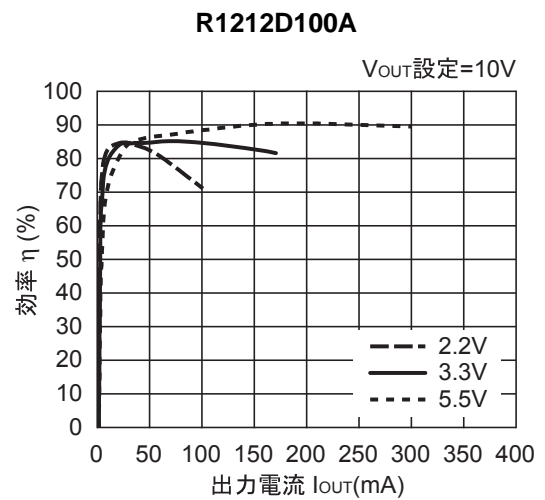
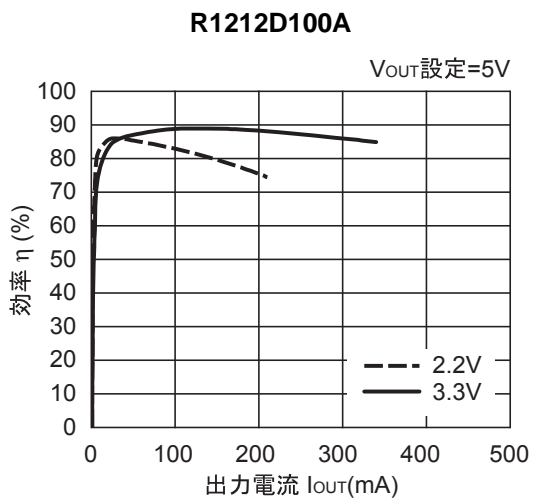

R1212D100A

R1212D100B

R1212D

NO.EA-109-160115

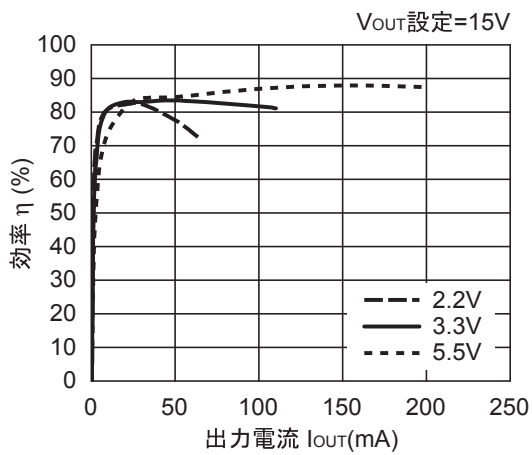

R1212D100B

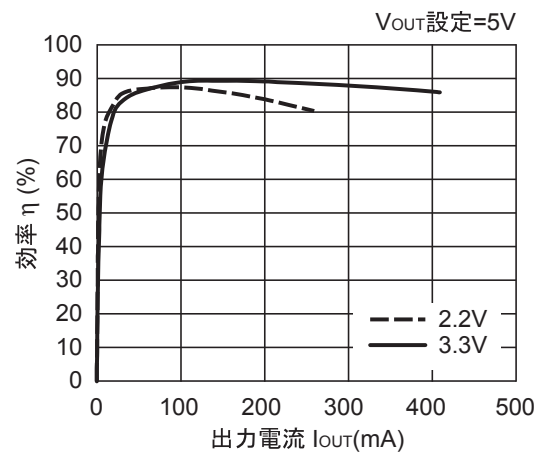

R1212D100B

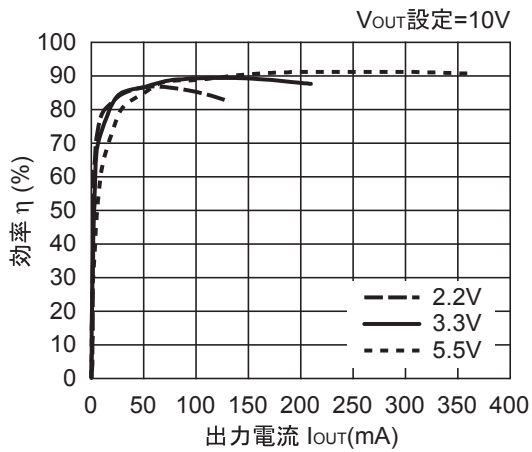

R1212D101C

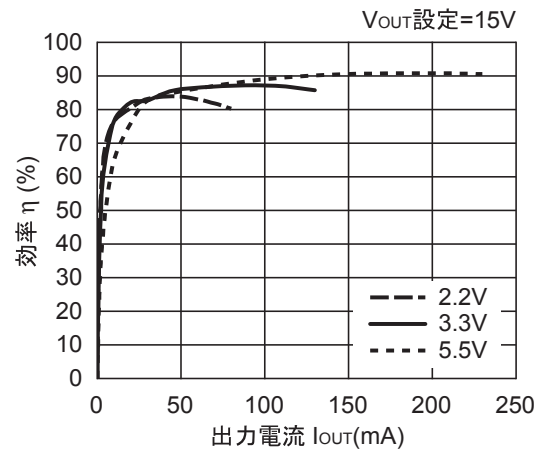

R1212D101C

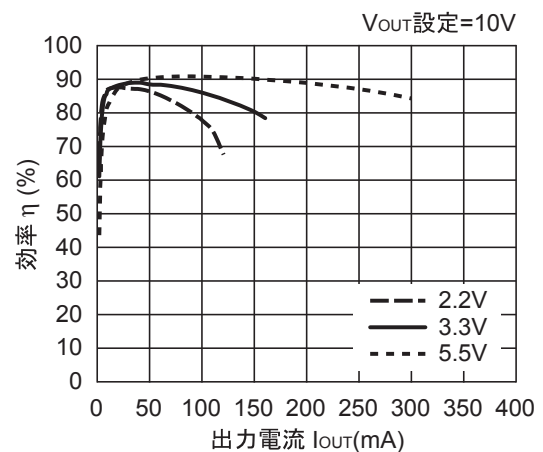
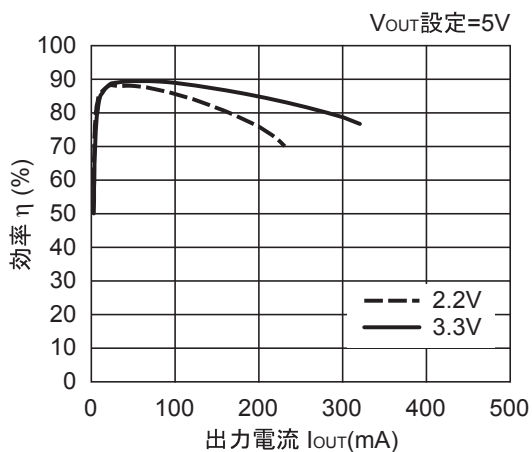

R1212D101C

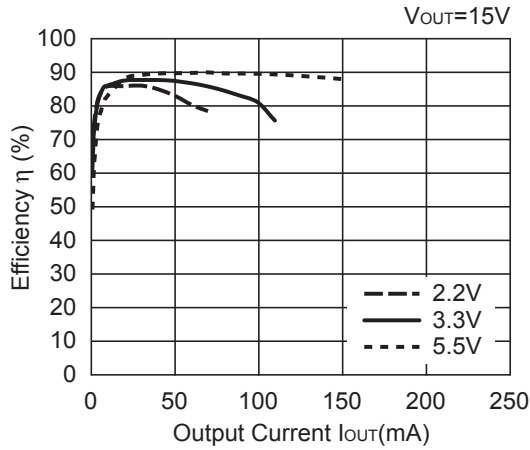

3) VFB Voltage vs. Input Voltage (Topt = 25°C)
R1212D100x

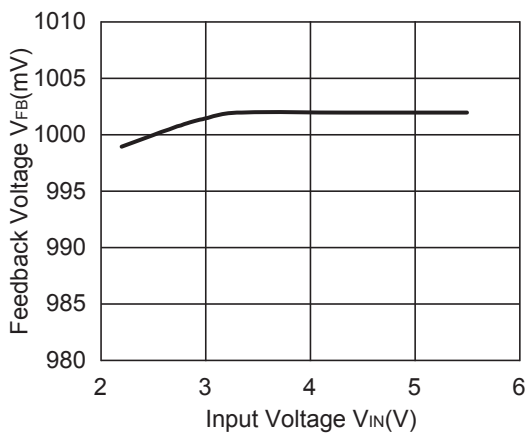

4) VFB Voltage vs. Temperature
R1212D100x

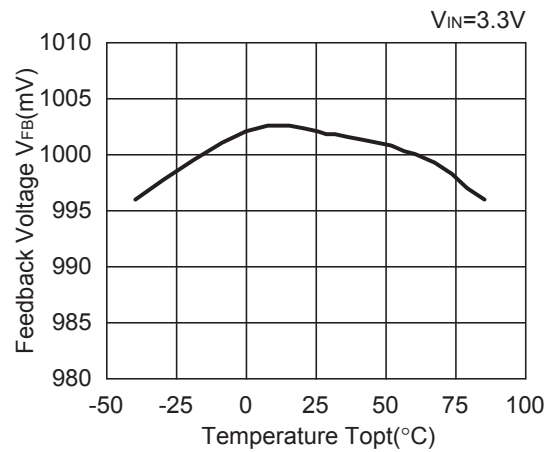

5) Oscillator Frequency vs. Input Voltage (Topt = 25°C)
R1212D100A

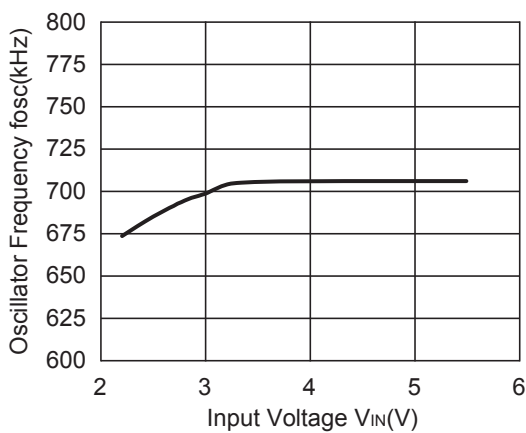

R1212D100B

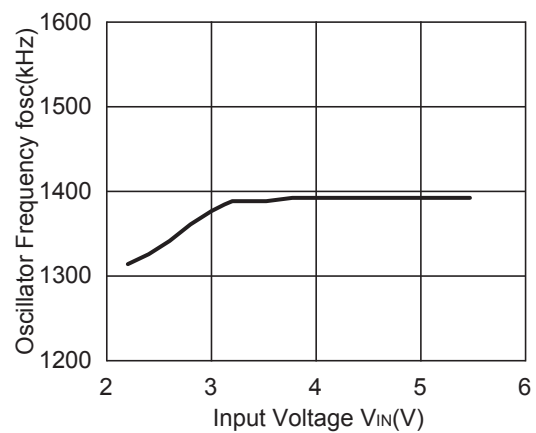

R1212D

NO.EA-109-160115

R1212D101C

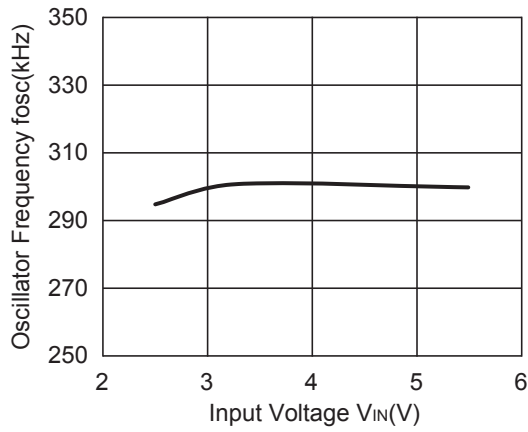

6) Oscillator Frequency vs. Temperature

R1212D10xA

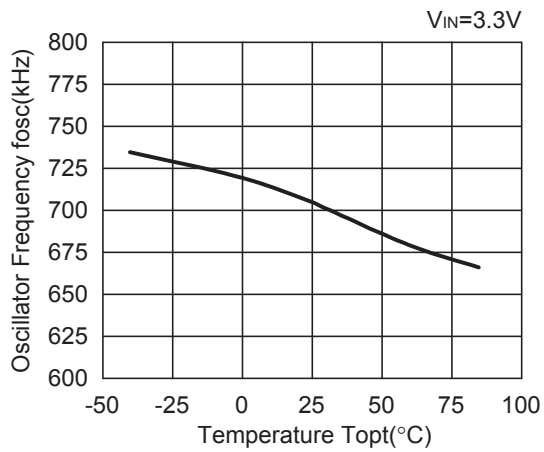

R1212D10xB

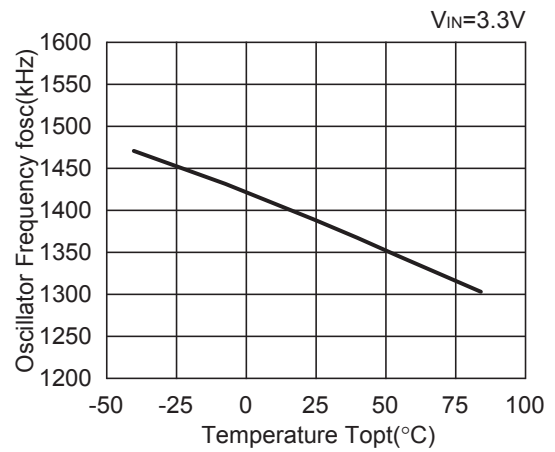

R1212D10xC

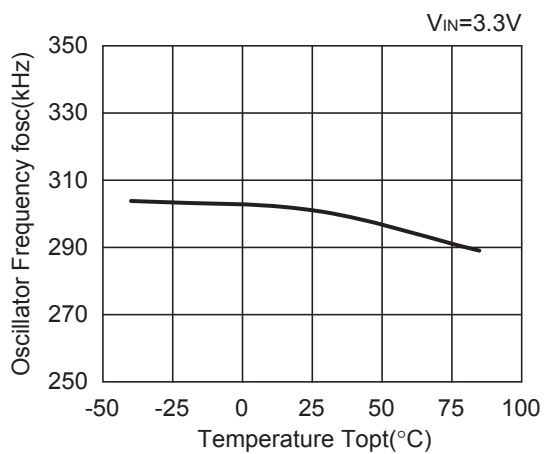

7) Supply Current vs. Input Voltage (Topt = 25°C at no load)

R1212D100A

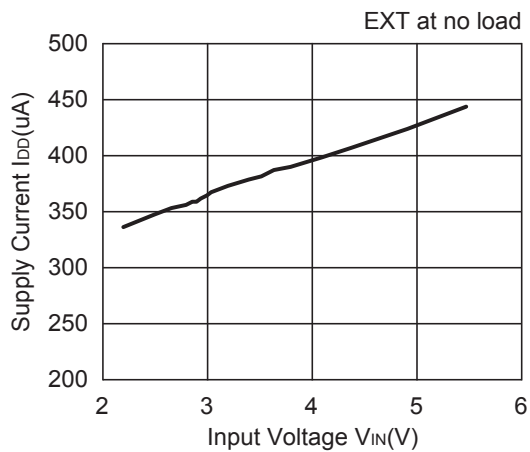

R1212D100B

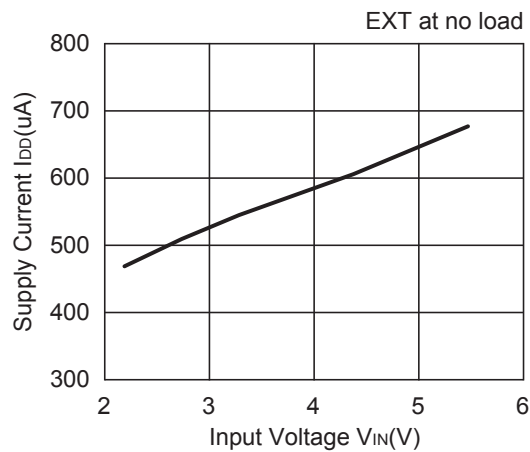

R1212D101C

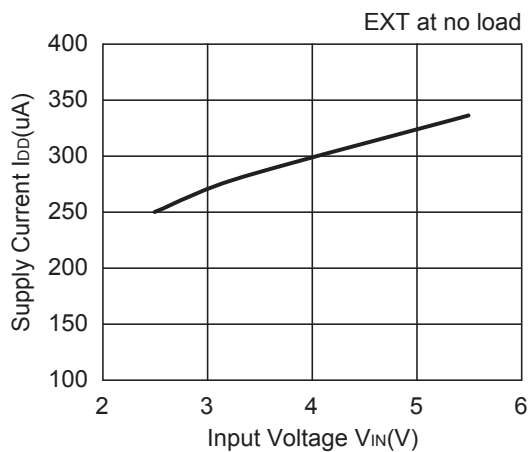

8) Supply Current vs. Temperature

R1212D10xA

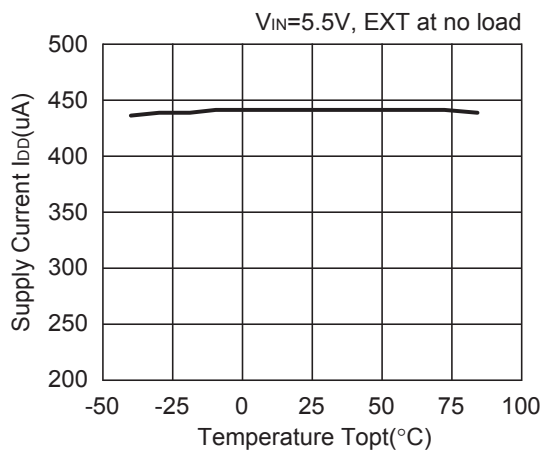

R1212D10xB

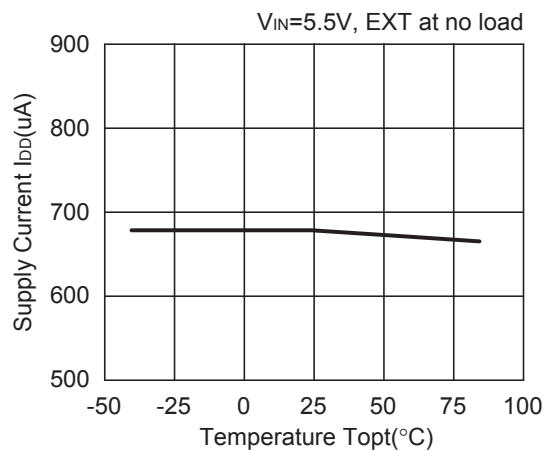

R1212D

NO.EA-109-160115

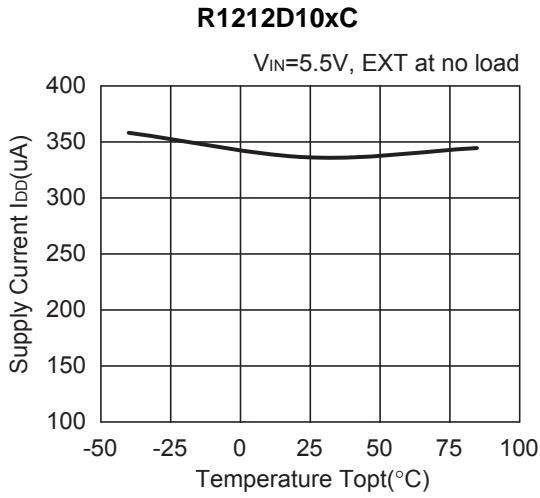

9) EXT "L" On Resistance vs. Temperature
R1212D10xx

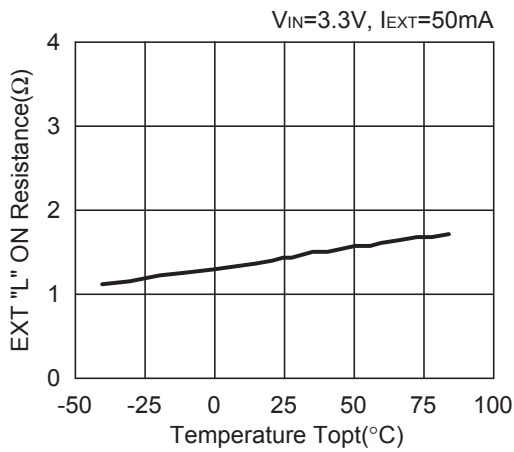

11) EXT Rising Time vs. Temperature
R1212D10xx

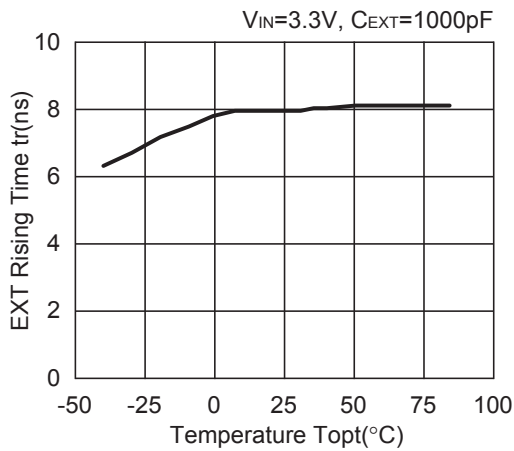

10) EXT "H" On Resistance vs. Temperature
R1212D10xx

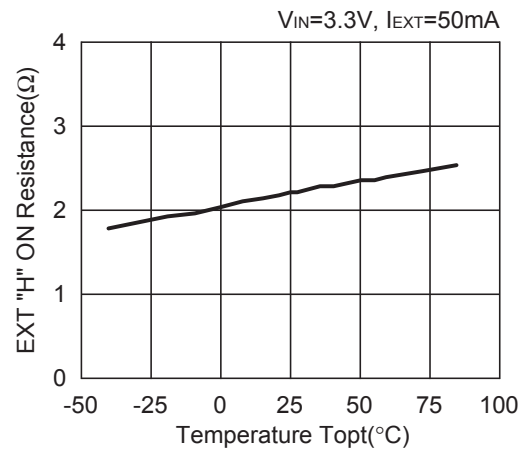

12) EXT Falling Time vs. Temperature
R1212D10xx

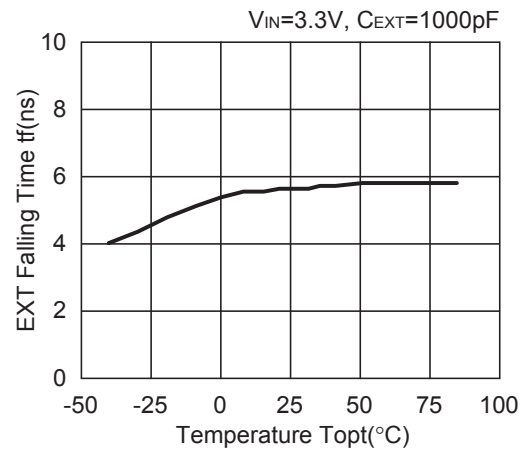

13) Duty Cycle vs. DTC Voltage (0% to 100%) (Topt = 25°C)

R1212D100A

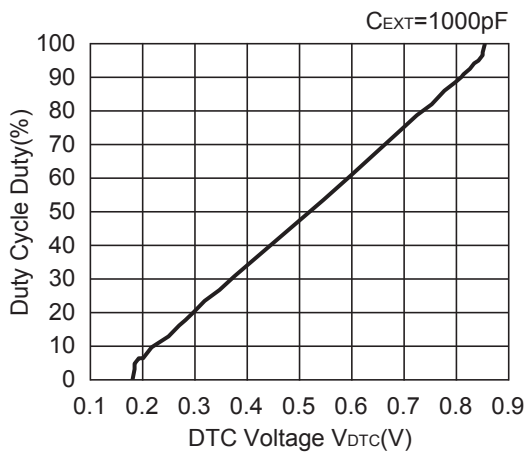

R1212D100B

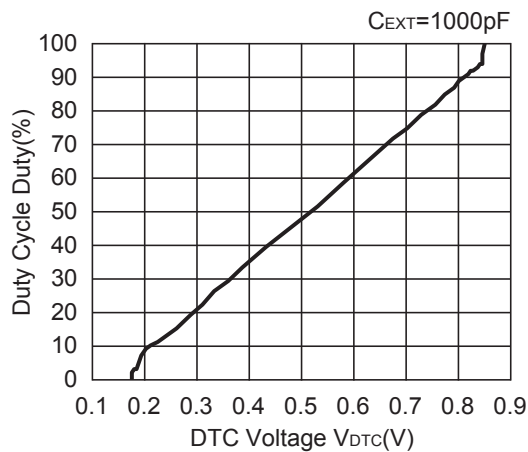

R1212D101A

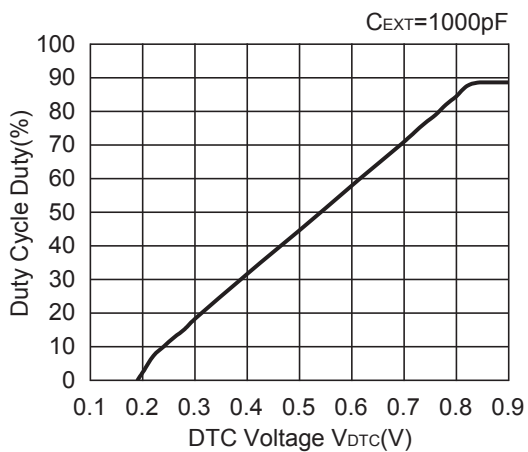

R1212D101C

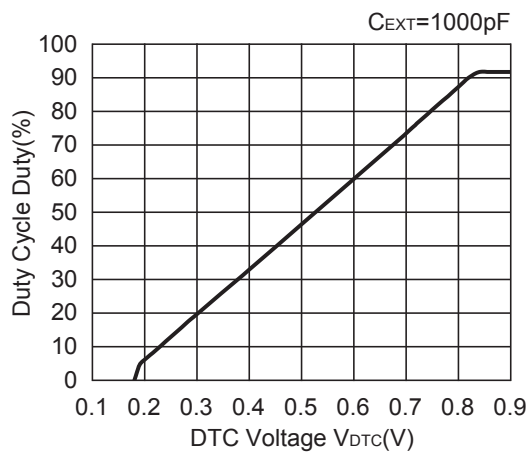

14) Duty Cycle vs. Temperature

R1212D100A

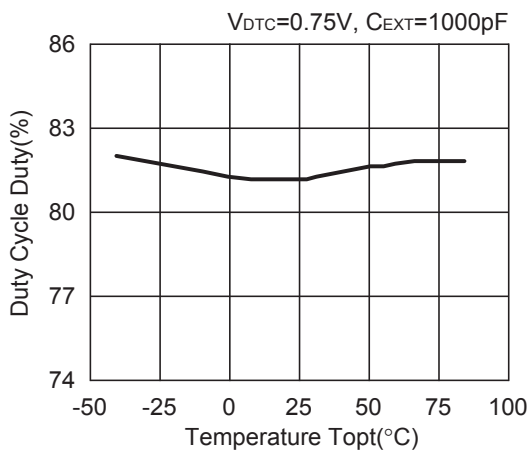

R1212D100B

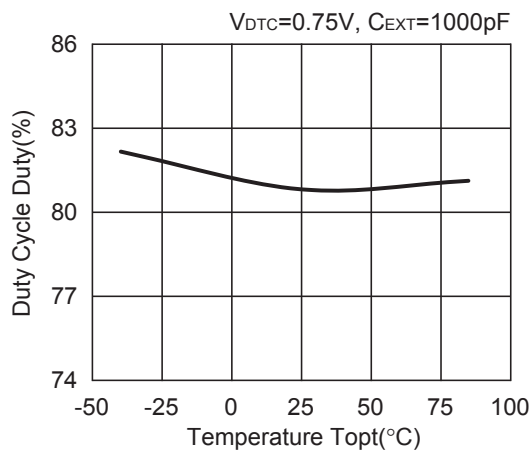

R1212D

NO.EA-109-160115

15) Maxduty vs. Temperature

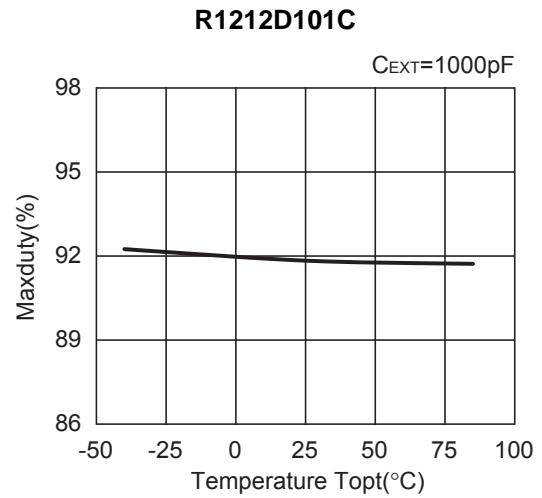
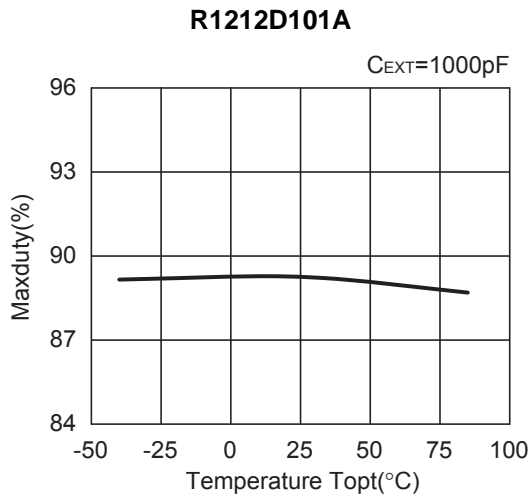

16) AMP "L" Output Current vs. Temperature

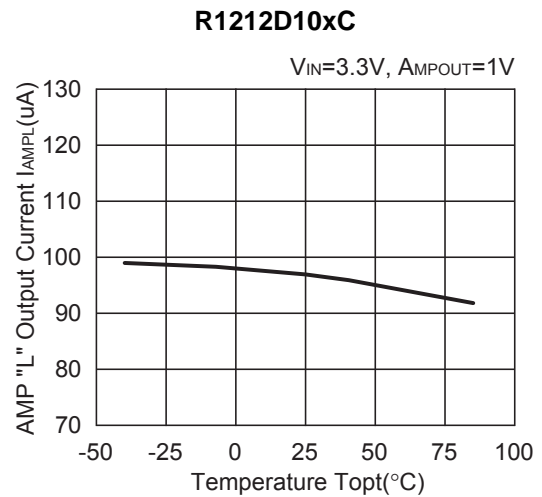
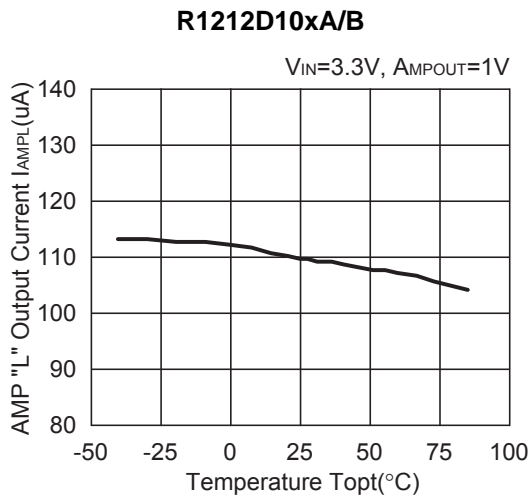

17) AMP "H" Output Current vs. Temperature

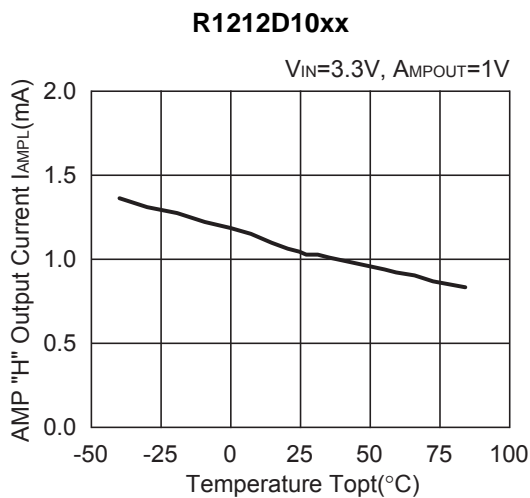

18) UVLO Detector Threshold UVLO Released Voltage vs. Temperature

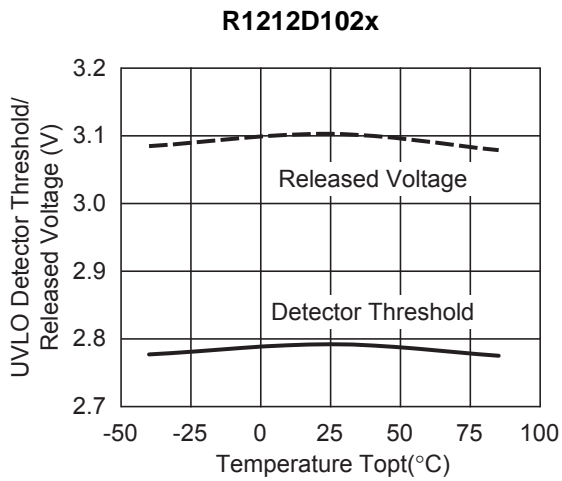
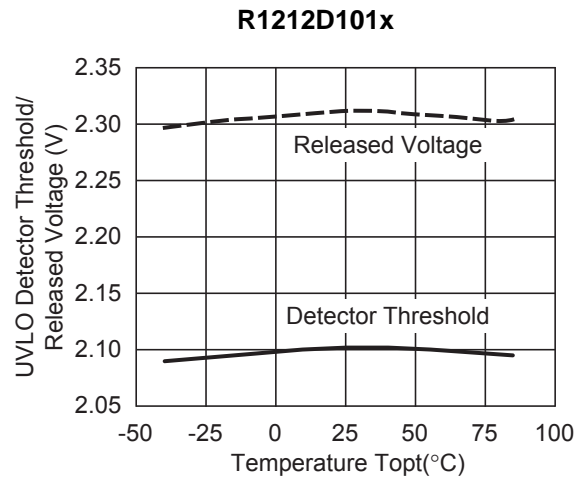
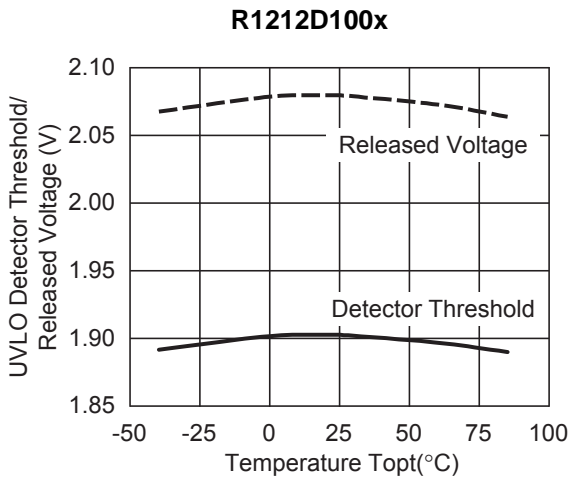

19) DELAY Pin Detector Threshold vs. Temperature

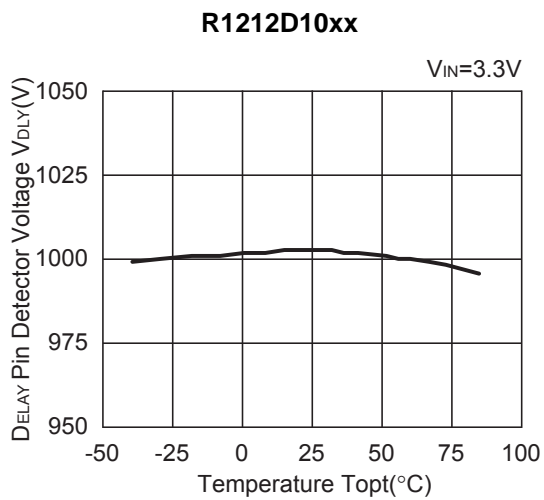

R1212D

NO.EA-109-160115

20) DELAY Pin Charge Current vs. Temperature

R1212D10xA/B

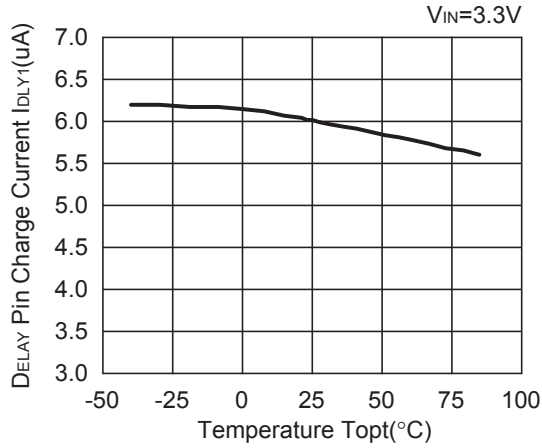

R1212D10xC

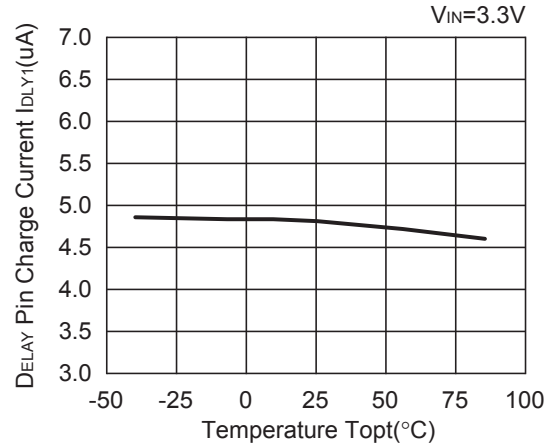

21) DELAY Pin Discharge Current vs. Temperature

R1212D10xx

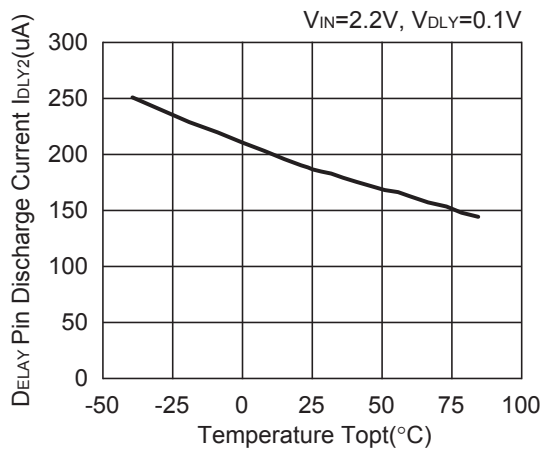

22) VREFOUT Voltage vs. Temperature

R1212D10xx

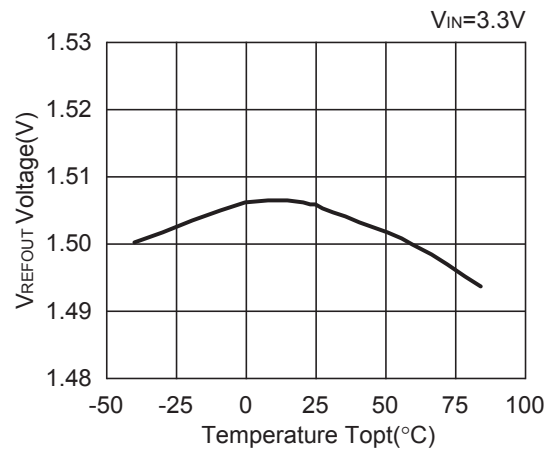

23) VREFOUT Voltage vs. Input Voltage (Topt = 25°C)

R1212D10xx

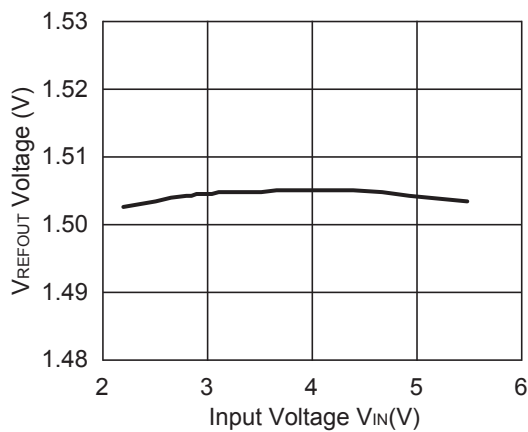

24) VREFOUT Voltage vs. Output Current (1) (Topt = 25°C)

R1212D100x

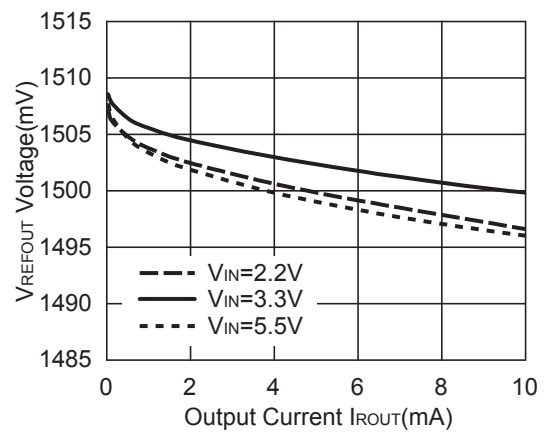

25) VREFOUT Voltage vs. Output Current (2) (Topt = 25°C) 26) Error Amplifier Gain/Phase vs. Frequency (Topt = 25°C)

R1212D100x

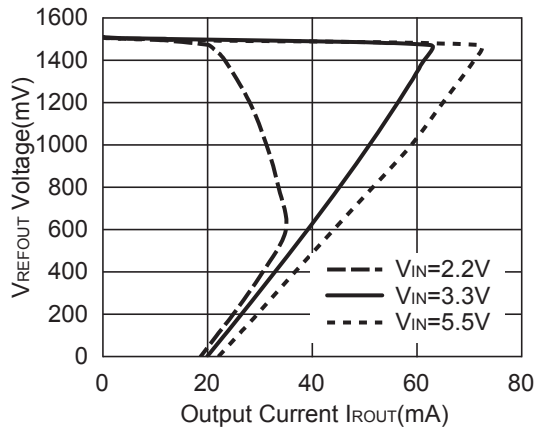

R1212D100xx

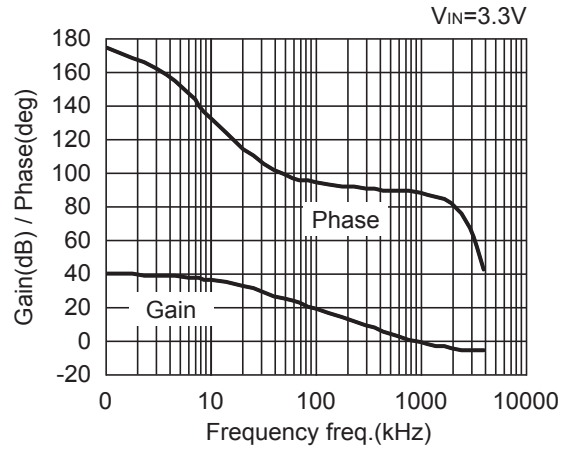

27) Power-on Response (VIN = 3.3 V, Topt = 25°C)

R1212D100A

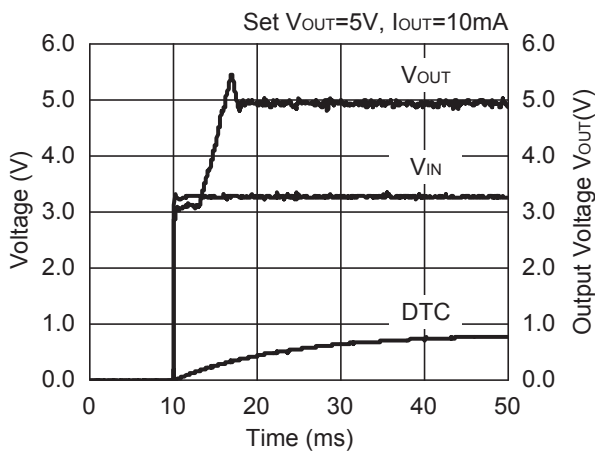

R1212D100A

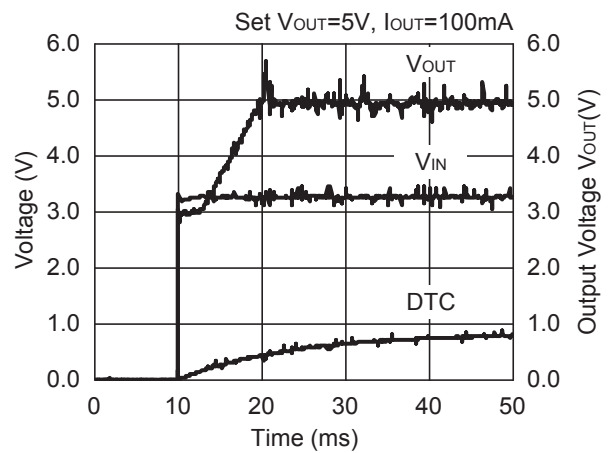

R1212D100A

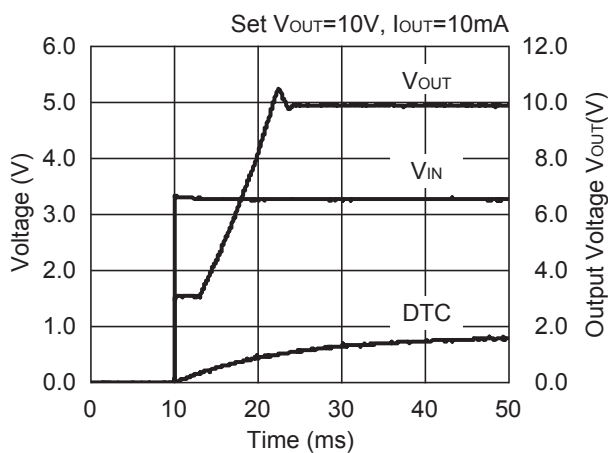

R1212D100A

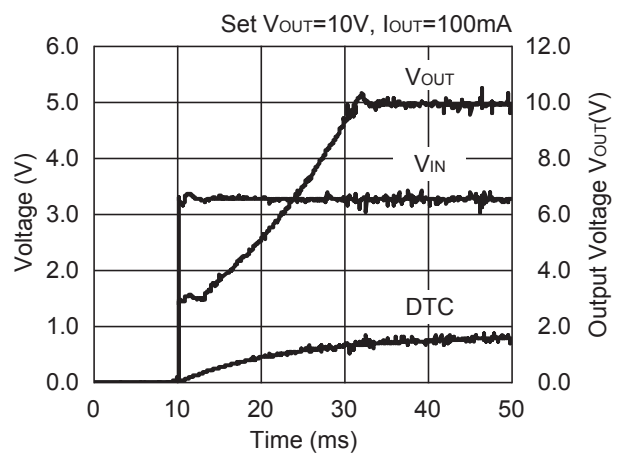

R1212D

NO.EA-109-160115

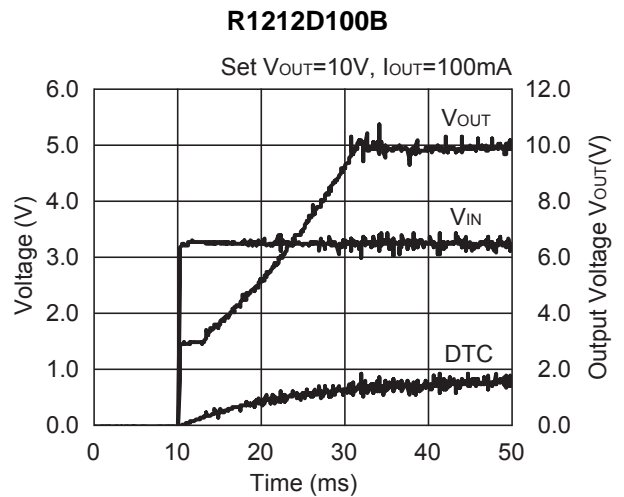
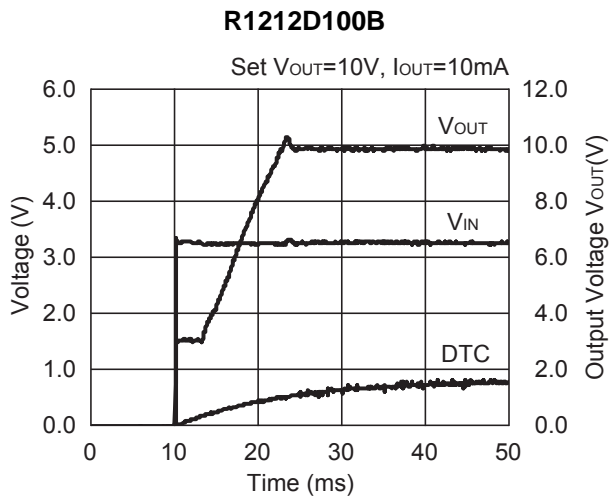
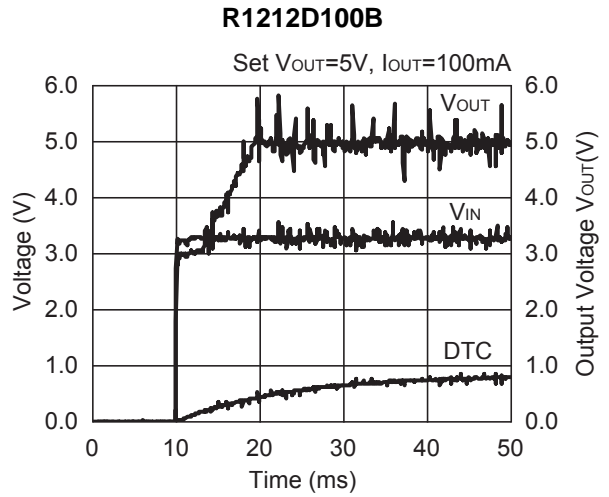
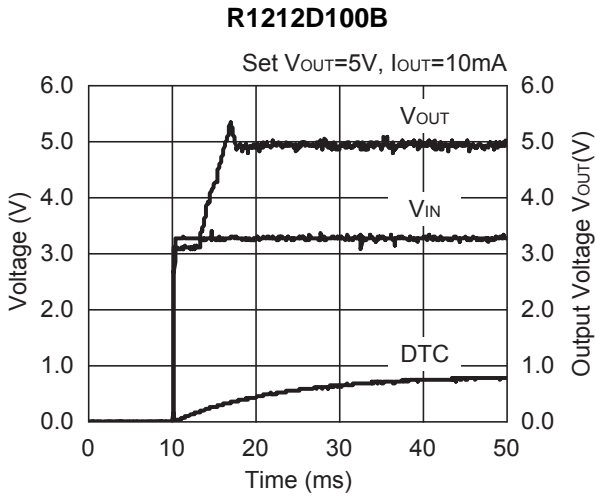
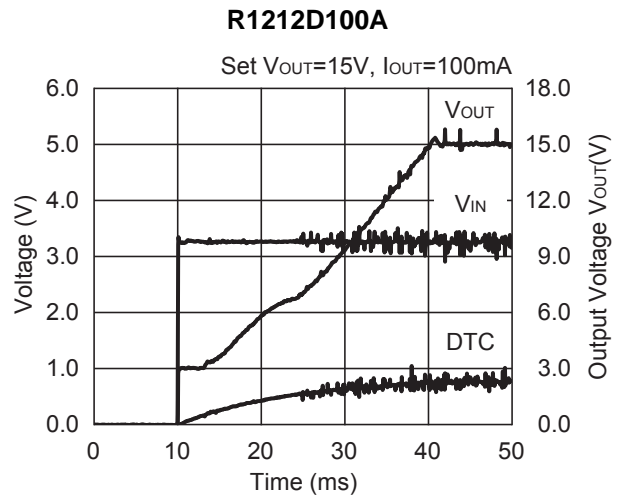
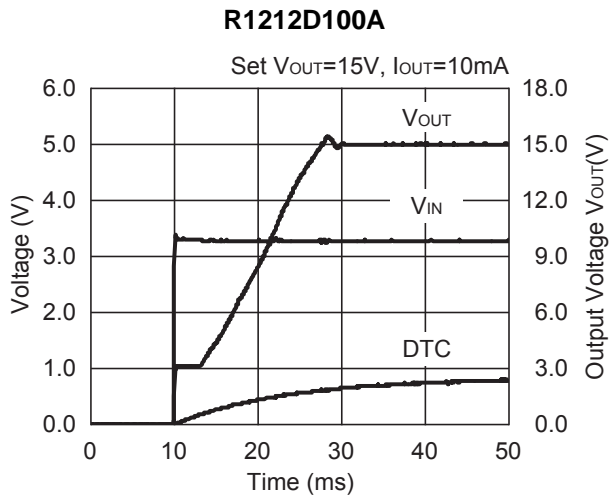

R1212D100B

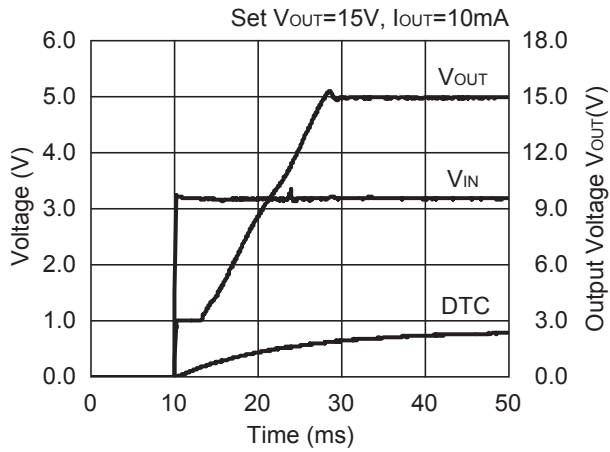

R1212D100B

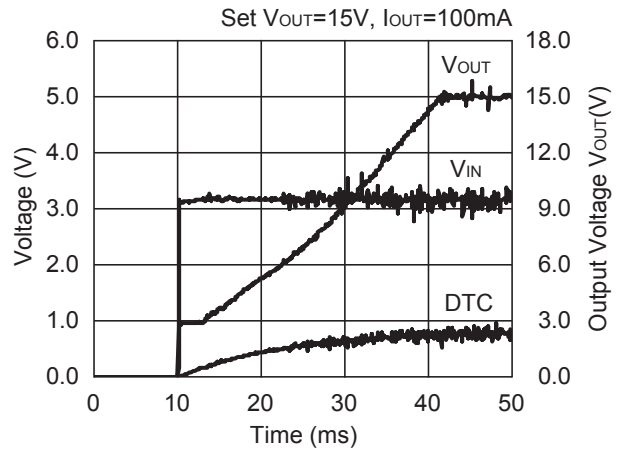

R1212D101C

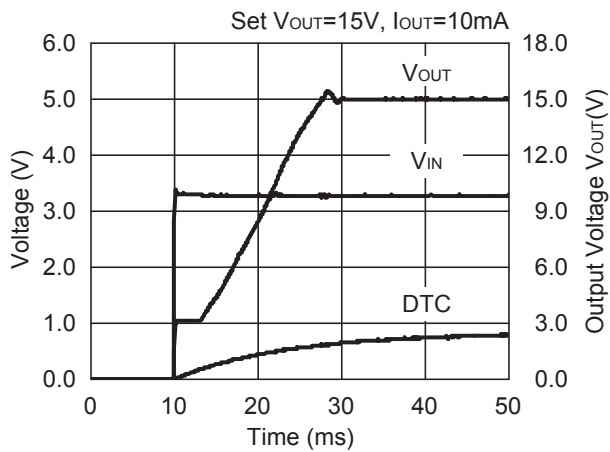

R1212D101C

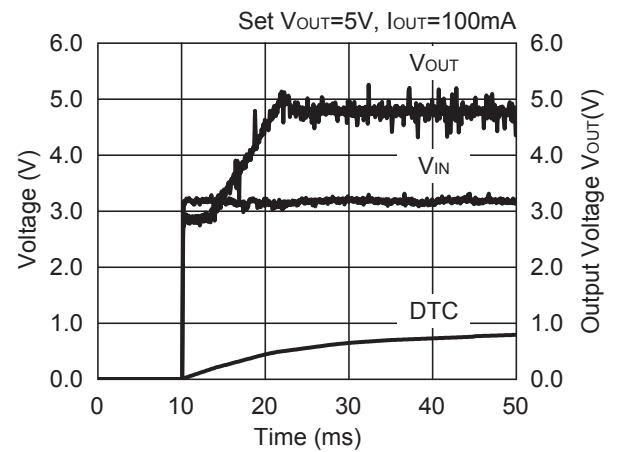

R1212D101C

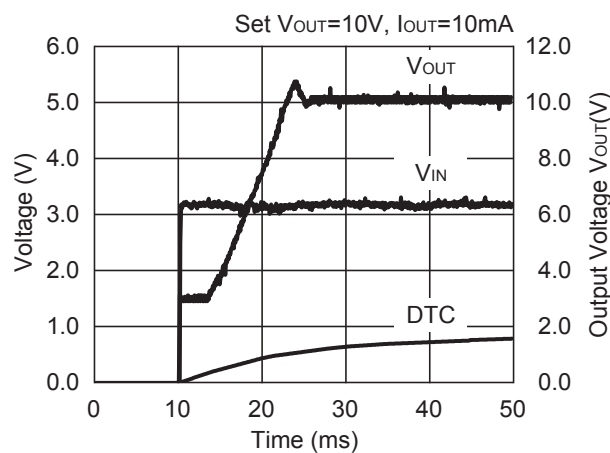

R1212D101C

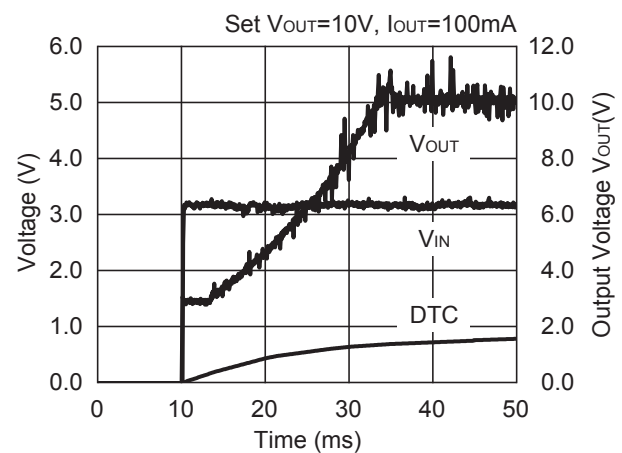

R1212D

NO.EA-109-160115

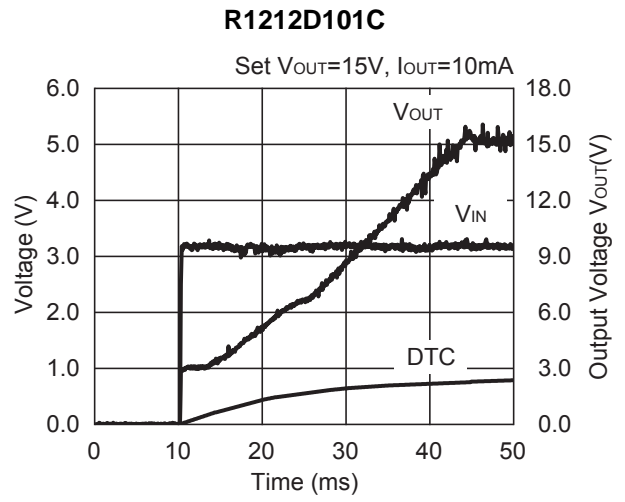
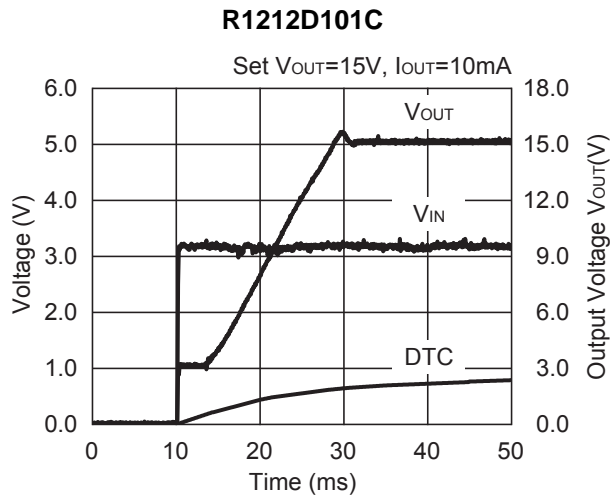

28) Load Transient Response ($V_{IN} = 3.3\text{ V}$, $T_{opt} = 25^{\circ}\text{C}$)

R1212D100A

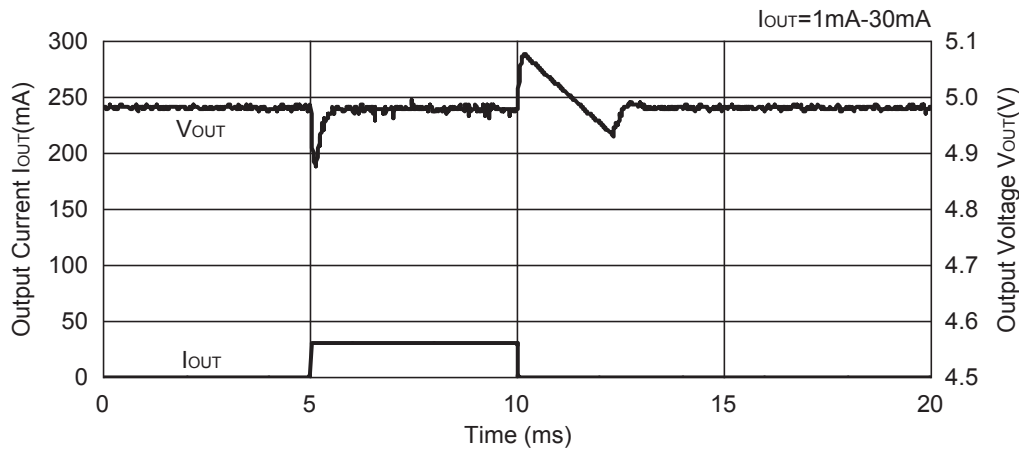

R1212D100A

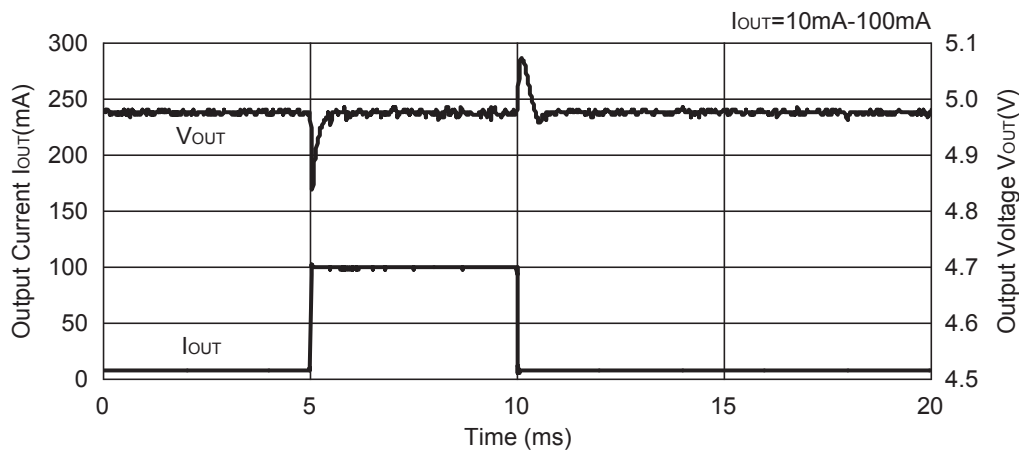

R1212D100A

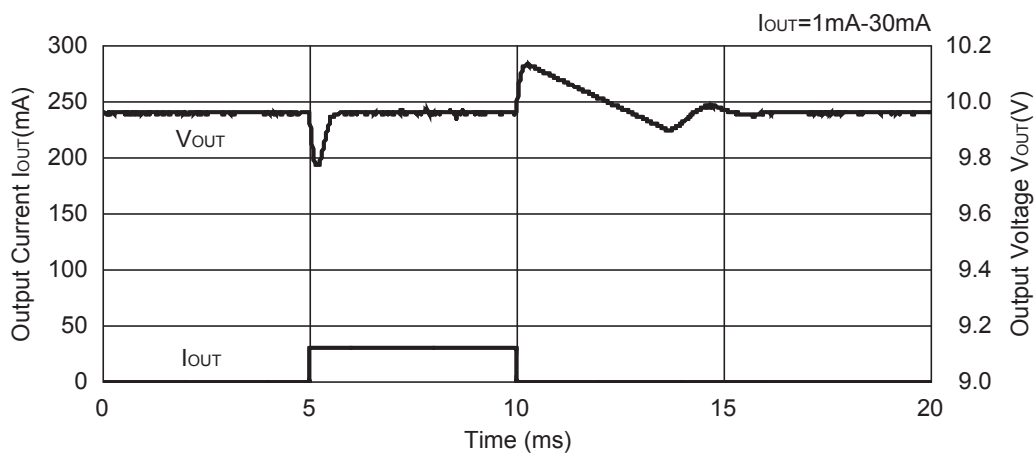

R1212D

NO.EA-109-160115

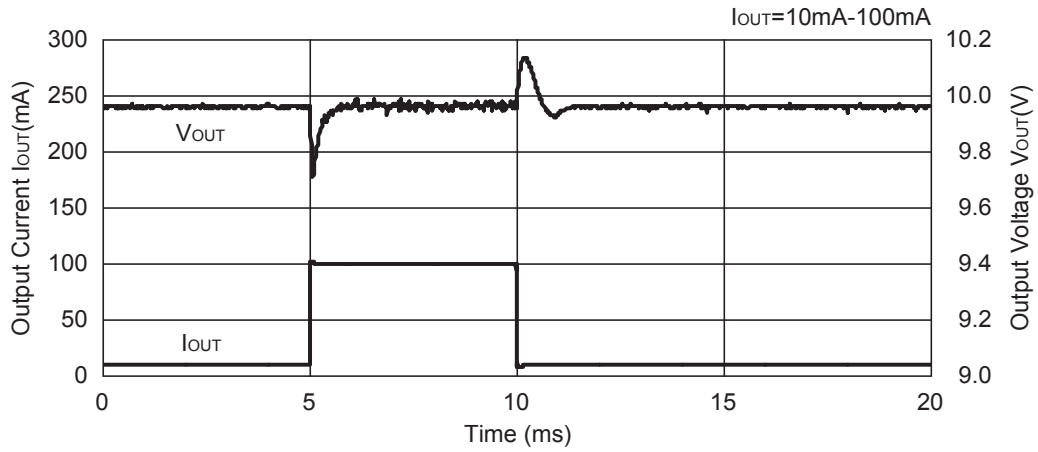
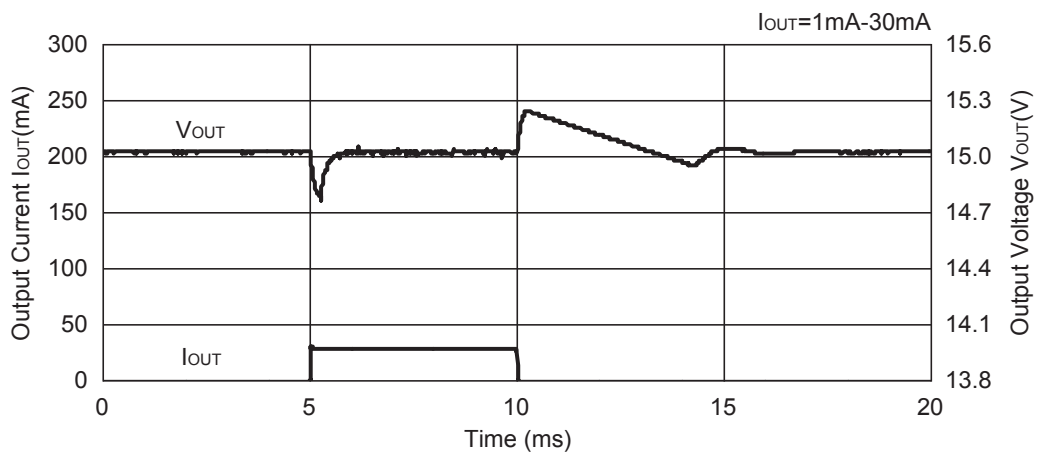
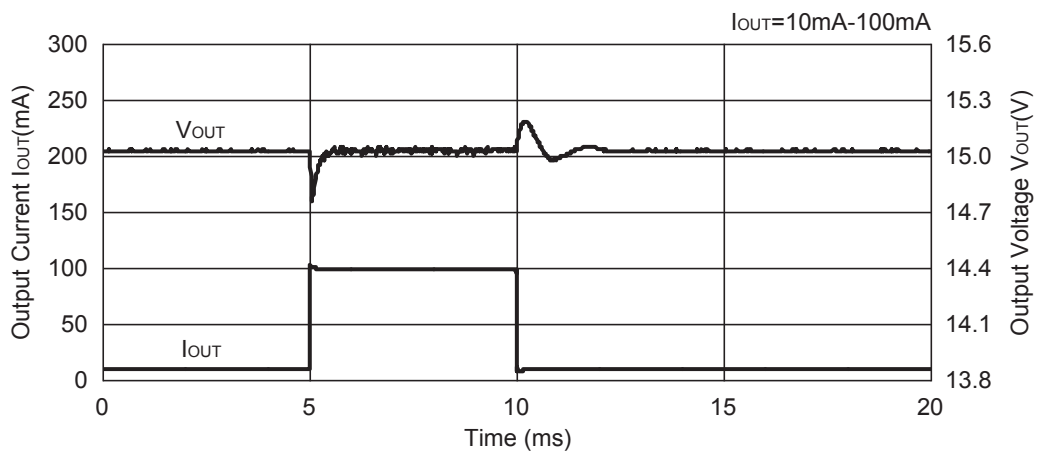
R1212D100A**R1212D100A****R1212D100A****R1212D100A**

R1212D100B

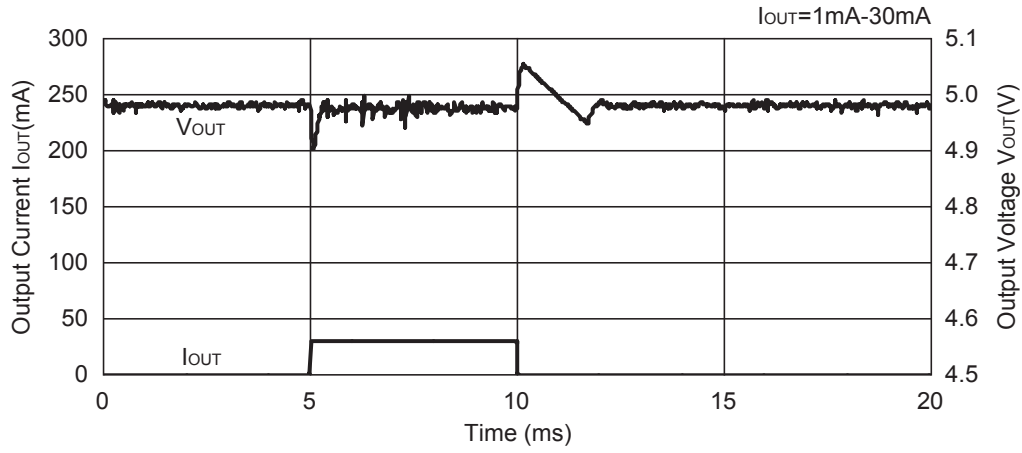

R1212D100B

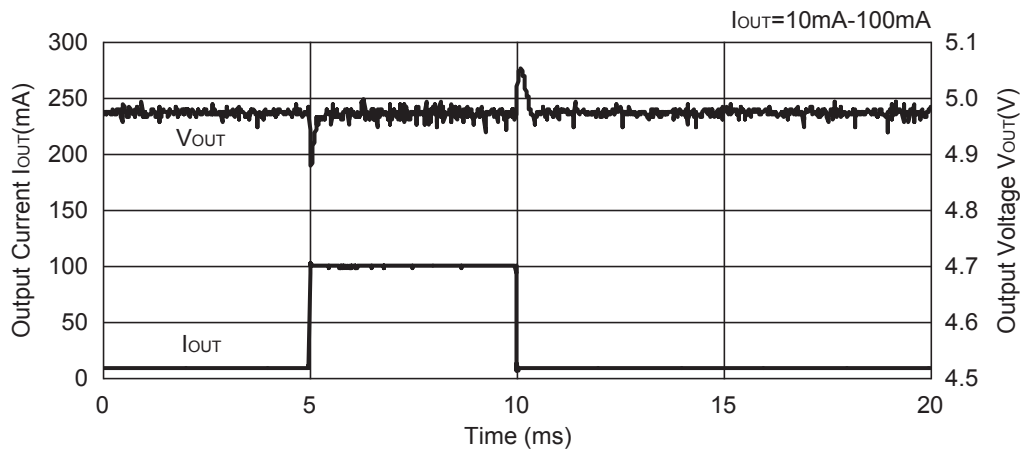

R1212D100B

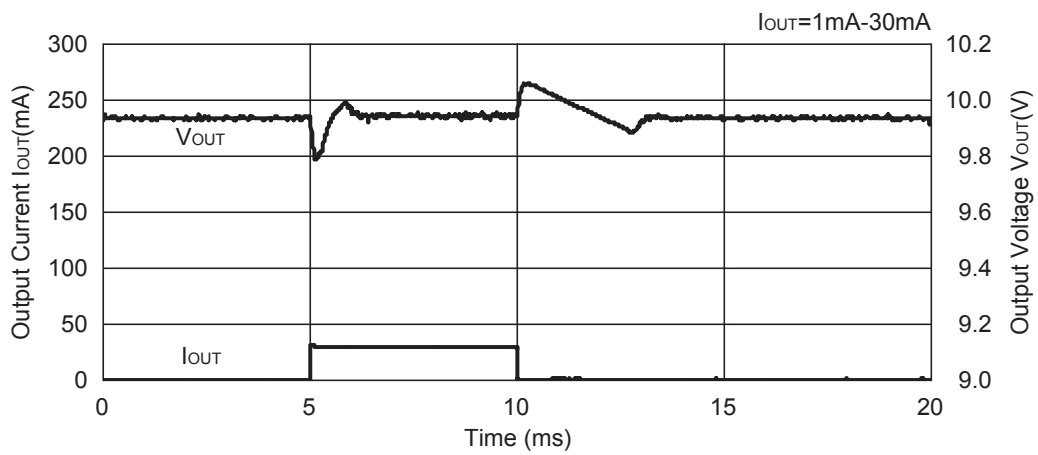

R1212D

NO.EA-109-160115

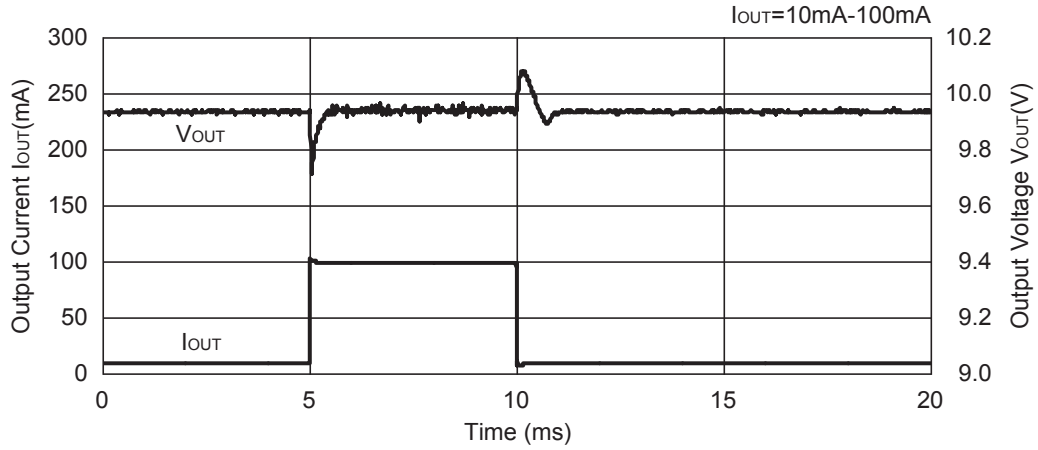
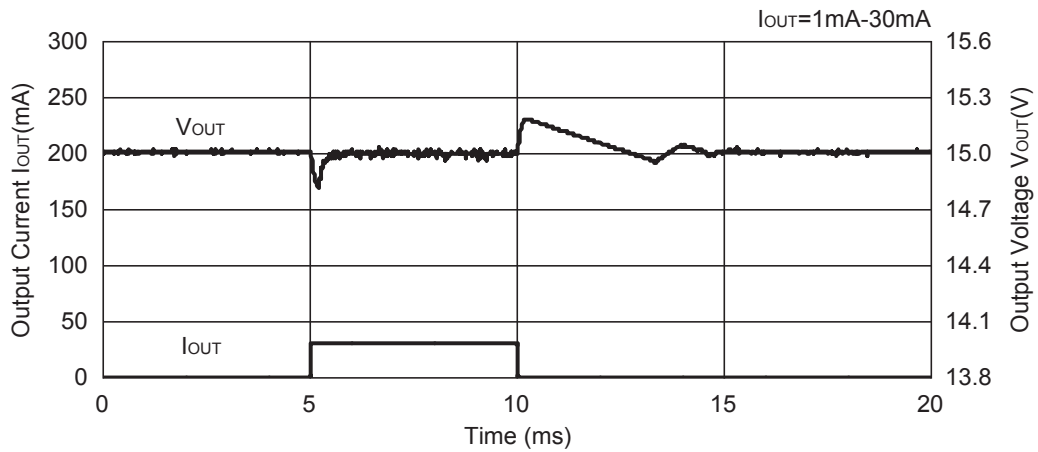
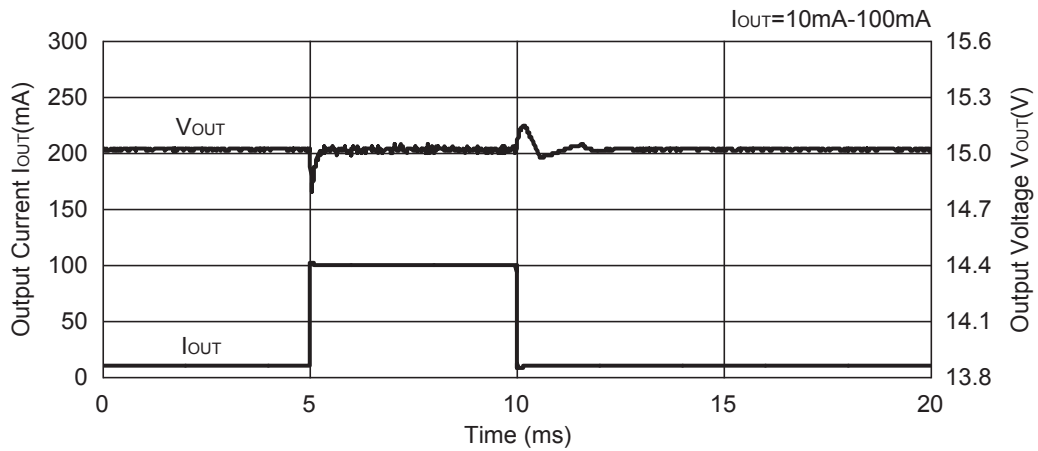
R1212D100B**R1212D100B****R1212D100B**

R1212D101C

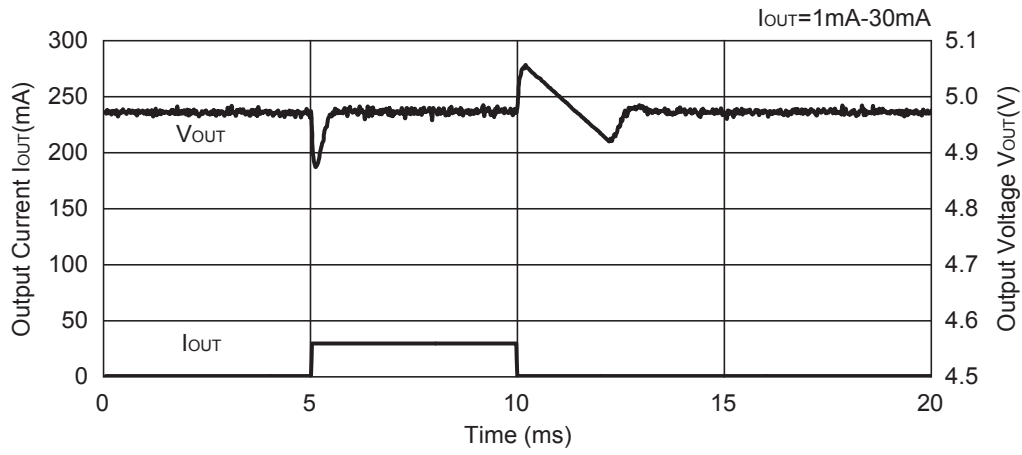

R1212D101C

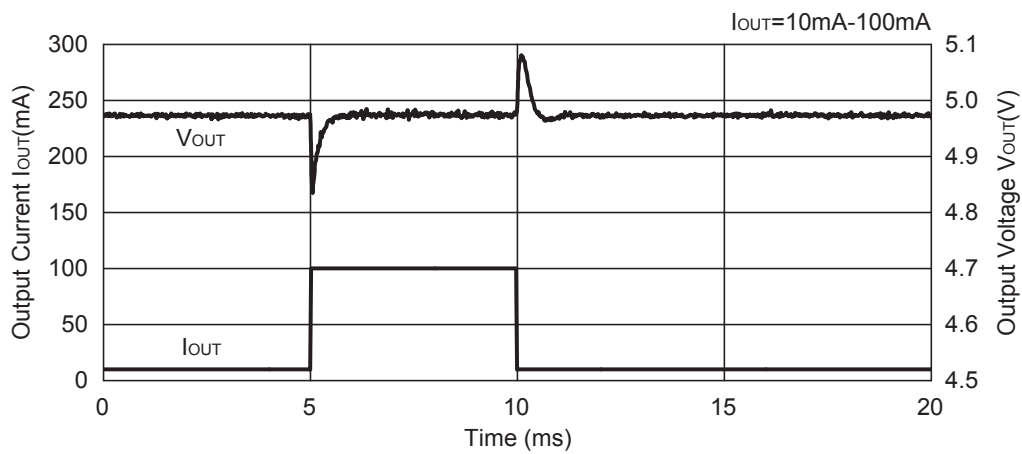

R1212D101C

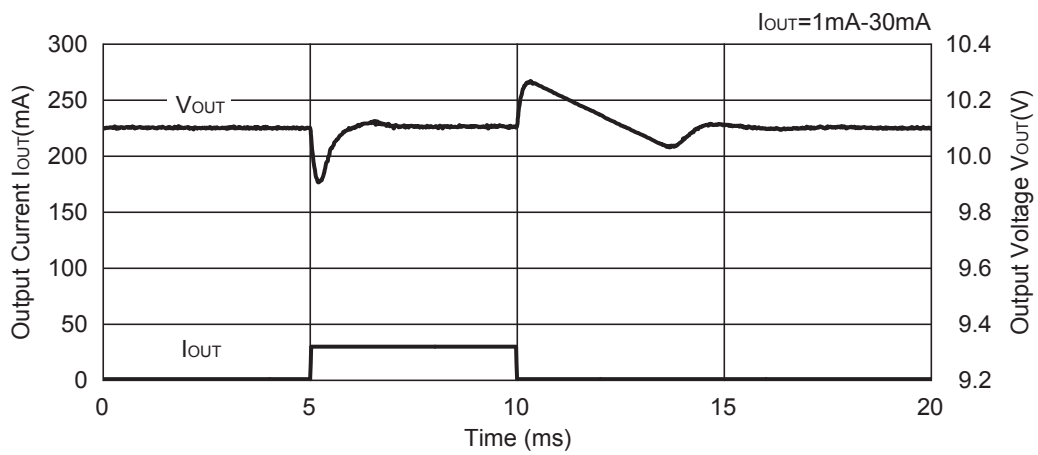

R1212D

NO.EA-109-160115

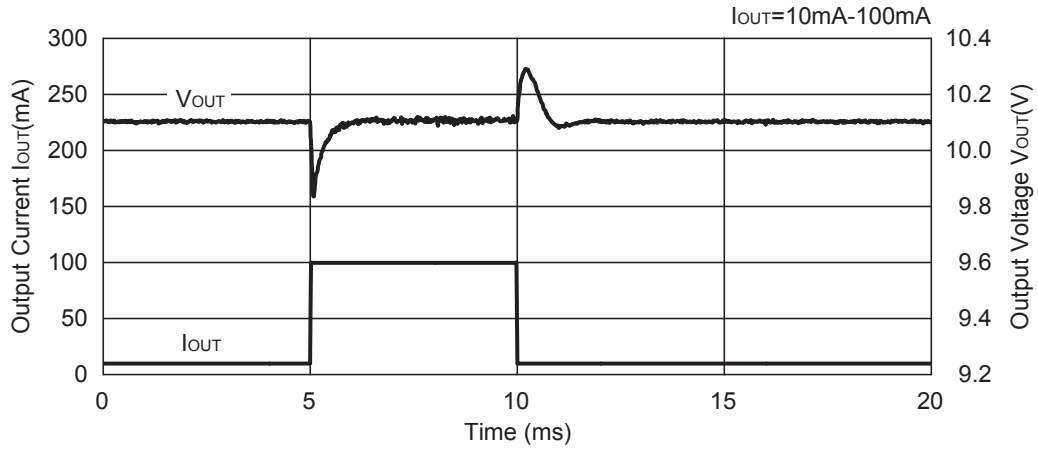
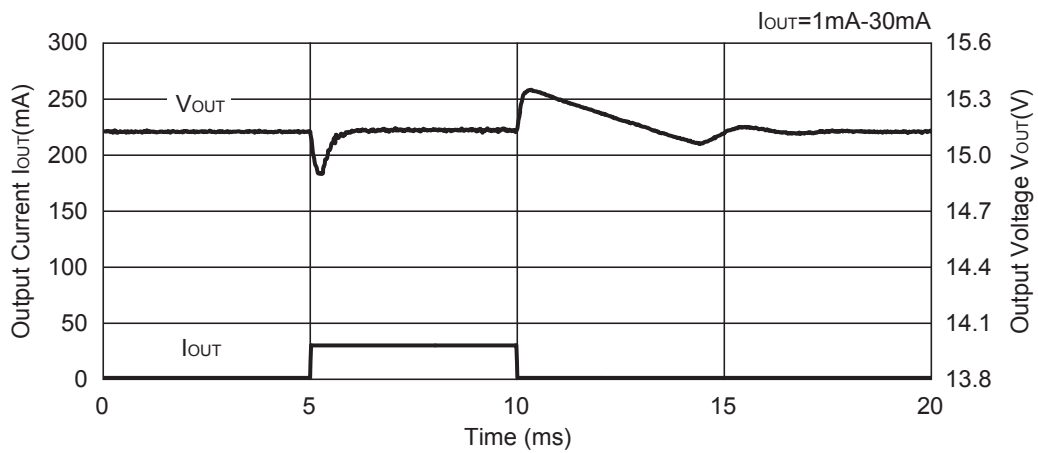
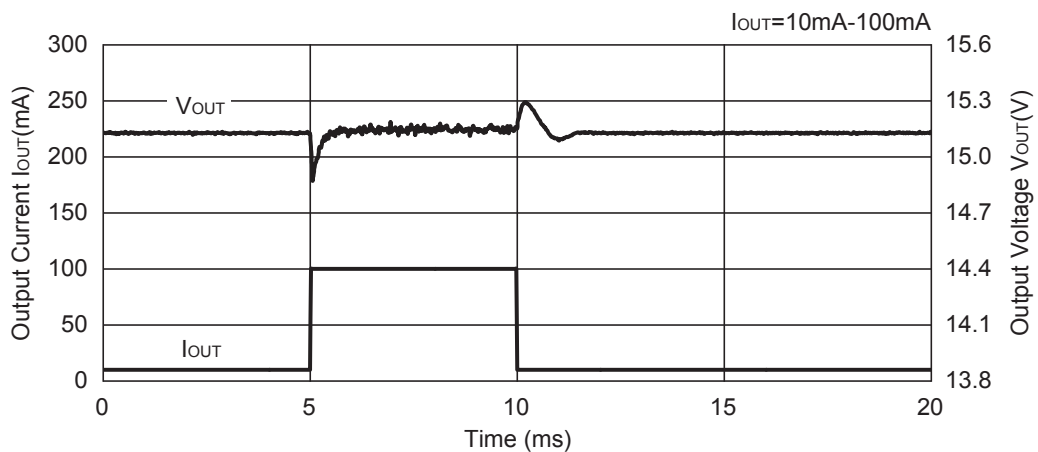
R1212D101C**R1212D101C****R1212D101C**



1. The products and the product specifications described in this document are subject to change or discontinuation of production without notice for reasons such as improvement. Therefore, before deciding to use the products, please refer to Ricoh sales representatives for the latest information thereon.
2. The materials in this document may not be copied or otherwise reproduced in whole or in part without prior written consent of Ricoh.
3. Please be sure to take any necessary formalities under relevant laws or regulations before exporting or otherwise taking out of your country the products or the technical information described herein.
4. The technical information described in this document shows typical characteristics of and example application circuits for the products. The release of such information is not to be construed as a warranty of or a grant of license under Ricoh's or any third party's intellectual property rights or any other rights.
5. The products listed in this document are intended and designed for use as general electronic components in standard applications (office equipment, telecommunication equipment, measuring instruments, consumer electronic products, amusement equipment etc.). Those customers intending to use a product in an application requiring extreme quality and reliability, for example, in a highly specific application where the failure or misoperation of the product could result in human injury or death (aircraft, spacevehicle, nuclear reactor control system, traffic control system, automotive and transportation equipment, combustion equipment, safety devices, life support system etc.) should first contact us.
6. We are making our continuous effort to improve the quality and reliability of our products, but semiconductor products are likely to fail with certain probability. In order to prevent any injury to persons or damages to property resulting from such failure, customers should be careful enough to incorporate safety measures in their design, such as redundancy feature, fire containment feature and fail-safe feature. We do not assume any liability or responsibility for any loss or damage arising from misuse or inappropriate use of the products.
7. Anti-radiation design is not implemented in the products described in this document.
8. The X-ray exposure can influence functions and characteristics of the products. Confirm the product functions and characteristics in the evaluation stage.
9. WLCSP products should be used in light shielded environments. The light exposure can influence functions and characteristics of the products under operation or storage.
10. There can be variation in the marking when different AOI (Automated Optical Inspection) equipment is used. In the case of recognizing the marking characteristic with AOI, please contact Ricoh sales or our distributor before attempting to use AOI.
11. Please contact Ricoh sales representatives should you have any questions or comments concerning the products or the technical information.



Ricoh is committed to reducing the environmental loading materials in electrical devices with a view to contributing to the protection of human health and the environment.

Ricoh has been providing RoHS compliant products since April 1, 2006 and Halogen-free products since April 1, 2012.

RICOH RICOH ELECTRONIC DEVICES CO., LTD.

<http://www.e-devices.ricoh.co.jp/en/>

Sales & Support Offices

RICOH ELECTRONIC DEVICES CO., LTD.

Higashi-Shinagawa Office (International Sales)
3-32-3, Higashi-Shinagawa, Shinagawa-ku, Tokyo 140-8655, Japan
Phone: +81-3-5479-2857 Fax: +81-3-5479-0502

RICOH EUROPE (NETHERLANDS) B.V.

Semiconductor Support Centre
Prof. W.H. Keesomlaan 1, 1183 DJ Amstelveen, The Netherlands
Phone: +31-20-5474-309

RICOH INTERNATIONAL B.V. - German Branch

Semiconductor Sales and Support Centre
Oberrather Strasse 6, 40472 Düsseldorf, Germany
Phone: +49-211-6546-0

RICOH ELECTRONIC DEVICES KOREA CO., LTD.

3F, Haesung Bldg, 504, Teheran-ro, Gangnam-gu, Seoul, 135-725, Korea
Phone: +82-2-2135-5700 Fax: +82-2-2051-5713

RICOH ELECTRONIC DEVICES SHANGHAI CO., LTD.

Room 403, No.2 Building, No.690 Bibo Road, Pu Dong New District, Shanghai 201203, People's Republic of China
Phone: +86-21-5027-3200 Fax: +86-21-5027-3299

RICOH ELECTRONIC DEVICES CO., LTD.

Taipei office
Room 109, 10F-1, No.51, Hengyang Rd., Taipei City, Taiwan (R.O.C.)
Phone: +886-2-2313-1621/1622 Fax: +886-2-2313-1623