STEP-UP DC/DC CONVERTER FOR WHITE LED BACK LIGHT

NO.EA-271-111123

OUTLINE

The R1203x Series are PWM control type step-up DC/DC converter ICs with low supply current.

The R1203x is fully dedicated to drive White LEDs with constant current. Each of these ICs consists of an NMOS FET, an oscillator, a PWM comparator, a voltage reference unit, an error amplifier, a current limit circuit, an under voltage lockout circuit (UVLO), and an over-voltage protection circuit (OVP).

The R1203x can drive white LEDs in constant current with high efficiency by using an inductor, a diode, a resistor and capacitors as external components.

The LEDs current can be set by an external resistance value and can adjust the dimming of LEDs by CE pin according to the signal of PWM. Feedback voltage is 0.2V, therefore power loss by current setting resistance is small and efficiency is good. Maximum duty cycle is internally fixed, Typ. 91%. LEDs can be driven from low voltage. Protection circuits are the current limit of Lx peak current, the over voltage limit of output, and the under voltage lockout function.

It is controllable the dimming of LEDs quickly when the PWM signal (between 200Hz to 300kHz) input to CE pin. If the CE pin input is "L" in the fixed time (Typ. 0.5ms), the IC becomes the standby mode and turns OFF LEDs.

FEATURES

- Supply Current Typ. 500 μ A
- Standby Current Max. 5 μ A
- Input Voltage Range 1.8V to 5.5V
- Feedback Voltage 0.2V
- Feedback Voltage Accuracy $\pm 1.0\%$ (± 10 mV)
- Temperature-Drift Coefficient of Feedback Voltage ... ± 150 ppm/ $^{\circ}$ C
- Oscillator Frequency Typ. 1.2MHz
- Maximum Duty Cycle Typ. 91%
- Switch ON Resistance Typ. 1.35 Ω
- UVLO Detector Threshold Typ. 1.6V
- Lx Current Limit Protection Typ. 700mA
- OVP Detector Threshold Typ. 29.5V
- Switching Control PWM
- LED dimming control by external PWM signal (Frequency 200Hz to 300kHz)
- Packages DFN1616-6B, SOT-23-6
- Ceramic capacitors are recommended 0.22 μ F

APPLICATION

- White LED Backlight for portable equipment

BLOCK DIAGRAMS

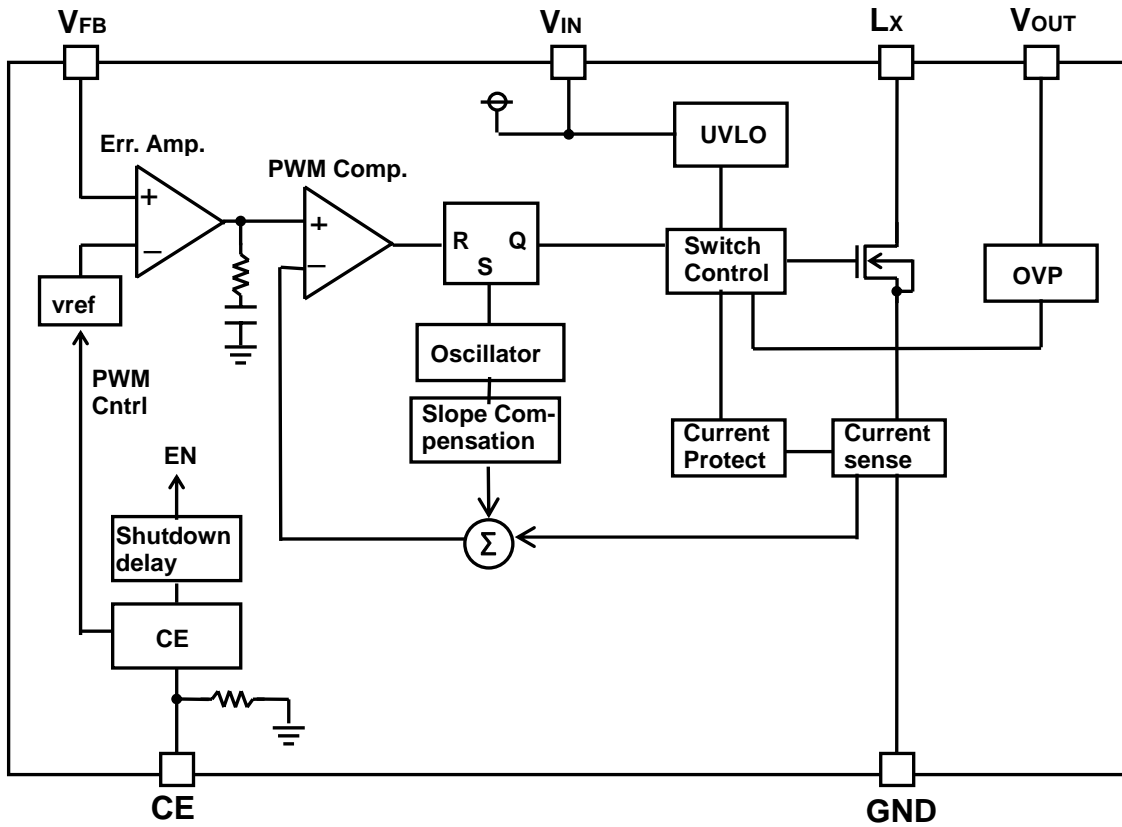

SELECTION GUIDE

The package for the ICs can be selected at the user's request.

Product Name	Package	Quantity per Reel	Pb Free	Halogen Free
R1203L071B-TR	DFN1616-6B	5,000 pcs	Yes	Yes
R1203N071B-TR-FE	SOT-23-6	3,000 pcs	Yes	Yes

PIN CONFIGURATIONS

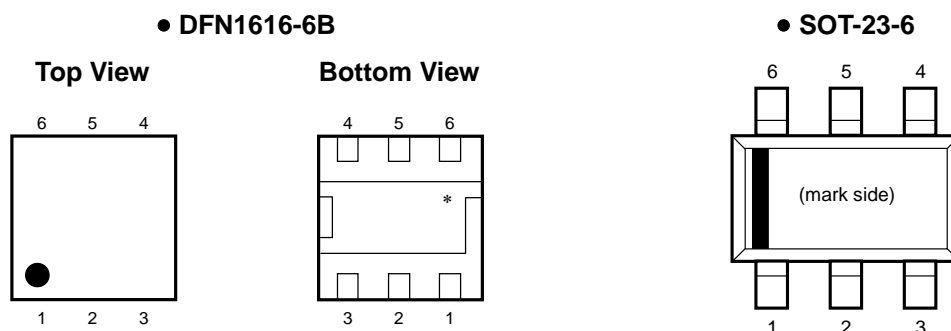

PIN DESCRIPTIONS

• DFN1616-6B

Pin No	Symbol	Pin Description
1	CE	Chip Enable Pin ("H" Active)
2	V_{FB}	Feedback Pin
3	LX	Switching Pin (Open Drain Output)
4	GND	Ground Pin
5	V_{IN}	Input Pin
6	V_{OUT}	Output Pin

*) Tab is GND level. (They are connected to the reverse side of this IC.)

The tab is better to be connected to the GND, but leaving it open is also acceptable.

• SOT-23-6

Pin No	Symbol	Pin Description
1	CE	Chip Enable Pin ("H" Active)
2	V_{OUT}	Output Pin
3	V_{IN}	Input Pin
4	LX	Switching Pin (Open Drain Output)
5	GND	Ground Pin
6	V_{FB}	Feedback Pin

ABSOLUTE MAXIMUM RATINGS

(GND=0V)

Symbol	Item	Rating	Unit
V_{IN}	V_{IN} Pin Voltage	-0.3 to 6.5	V
V_{CE}	CE Pin Voltage	-0.3 to $V_{IN}+0.3$	V
V_{FB}	V_{FB} Pin Voltage	-0.3 to $V_{IN}+0.3$	V
V_{OUT}	V_{OUT} Pin Voltage	-0.3 to 32	V
V_{LX}	L_x Pin Voltage	-0.3 to 32	V
I_{LX}	L_x Pin Current	1000	mA
P_D	Power Dissipation (DFN1616-6B)*	640	mW
	Power Dissipation (SOT-23-6)*	420	
T_a	Operating Temperature Range	-40 to 85	°C
T_{stg}	Storage Temperature Range	-55 to 125	°C

*) For Power Dissipation, please refer to PACKAGE INFORMATION.

ABSOLUTE MAXIMUM RATINGS

Electronic and mechanical stress momentarily exceeded absolute maximum ratings may cause the permanent damages and may degrade the life time and safety for both device and system using the device in the field. The functional operation at or over these absolute maximum ratings is not assured.

ELECTRICAL CHARACTERISTICS

• R1203x

(Ta=25°C)

Symbol	Item	Conditions	Min.	Typ.	Max.	Unit
V _{IN}	Operating Input Voltage		1.8		5.5	V
I _{DD}	Supply Current	V _{IN} =5.5V, V _{FB} =0V, Lx at no load		0.5	1.0	mA
I _{standby}	Standby Current	V _{IN} =5.5V, V _{CE} =0V		1.0	5.0	μA
V _{UVLO1}	UVLO Detector Threshold	V _{IN} falling	1.5	1.6	1.7	V
V _{UVLO2}	UVLO Released Voltage	V _{IN} rising		V _{UVLO1} +0.1	1.8	V
V _{CEH}	CE Input Voltage "H"	V _{IN} =5.5V	1.5			V
V _{CEL}	CE Input Voltage "L"	V _{IN} =1.8V			0.5	V
R _{CE}	CE Pull Down Resistance	V _{IN} =3.6V	600	1200	2200	kΩ
V _{FB}	V _{FB} Voltage Accuracy	V _{IN} =V _{CE} =3.6V	0.19	0.20	0.21	V
$\frac{\Delta V_{FB}}{\Delta T_a}$	V _{FB} Voltage Temperature Coefficient	V _{IN} =V _{CE} =3.6V, -40°C ≤ T _a ≤ 85°C		±150		ppm/°C
I _{FB}	V _{FB} Input Current	V _{IN} =5.5V, V _{FB} =0V or V _{IN}	-0.1		0.1	μA
R _{ON}	Switch ON Resistance	V _{IN} =3.6V, I _{LX} =100mA		1.35		Ω
I _{LXleak}	Switch Leakage Current	V _{LX} =30V		0	3.0	μA
I _{LXlim}	Switch Current Limit	V _{IN} =3.6V	400	700	1000	mA
f _{osc}	Oscillator Frequency	V _{IN} =3.6V, V _{OUT} =V _{FB} =0V	1.0	1.2	1.4	MHz
Maxduty	Maximum Duty Cycle	V _{IN} =3.6V, V _{OUT} =V _{FB} =0V	86	91		%
V _{OVP1}	OVP Detector Threshold	V _{IN} =3.6V, V _{OUT} rising	28.7	29.5	30.3	V
$\frac{\Delta V_{OVP1}}{\Delta T_a}$	V _{OVP1} Voltage Temperature Coefficient	V _{IN} =V _{CE} =3.6V, -40°C ≤ T _a ≤ 85°C		±150		ppm/°C
V _{OVP2}	OVP Released Voltage	V _{IN} =3.6V, V _{OUT} falling		V _{OVP1} -1.55		V

RECOMMENDED OPERATING CONDITIONS (ELECTRICAL CHARACTERISTICS)

All of electronic equipment should be designed that the mounted semiconductor devices operate within the recommended operating conditions. The semiconductor devices cannot operate normally over the recommended operating conditions, even if when they are used over such conditions by momentary electronic noise or surge. And the semiconductor devices may receive serious damage when they continue to operate over the recommended operating conditions.

TYPICAL APPLICATIONS

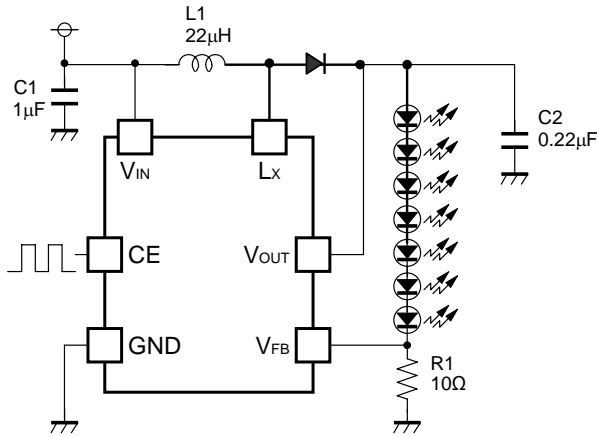

C1	CM105B105K06
C2	GRM21BR71H224
L1	LQH32CN220K53

• **LED Current setting**

When CE pin input is "H" (Duty=100%), LED current can be set with feedback resistor (R1)

$$I_{LED} = V_{FB} / R1$$

• **LED Dimming Control**

The LED brightness can be controlled by inputting the PWM signal to the CE pin. If the CE pin input is "L" in the fixed time (Typ.0.5ms), the IC becomes the standby mode and turns OFF LEDs.

The current of LEDs when the CE pin is "H" input (Duty=100%) is shown by the above expression. The current of LEDs can be controlled by Duty of the PWM signal of the input CE pin. The current of LEDs when High-Duty of the CE input is Hduty reaches the value as calculatable following formula.

$$I_{LED} = Hduty \times V_{FB} / R1$$

The frequency of the PWM signal is using the range between 200Hz to 300kHz.

When controlling the LED brightness by the PWM signal of 20kHz or less; The increasing or decreasing of the inductor current might be make a sounds in the hearable sound wave area. In that case, please use the PWM signal in the high frequency area.

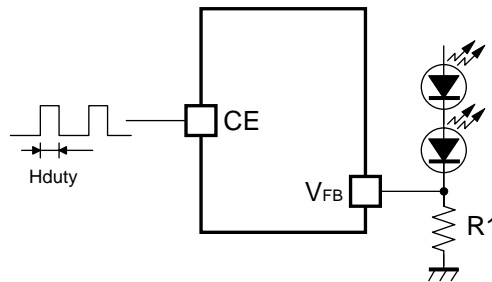

Dimming control by CE pin input

- **Soft-Start**

The output of the error amplifier starts from 0V and the inrush current is suppressed when starting by the CE pin "H" input.

Moreover, the inrush current can be suppressed by gradually enlarging Duty of the PWM signal to the CE pin.

- **Selection of Inductors**

The peak current of the inductor at normal mode can be calculated as next formula:

$$I_{Lmax}=1.25 \times I_{LED} \times V_{OUT} / V_{IN} + 0.5 \times V_{IN} \times (V_{OUT} - V_{IN}) / (L \times V_{OUT} \times f_{osc})$$

When the start-up or dimming control by CE pin, transient current flows, the peak current must be equal or less than the current limit of the IC. The peak current should not beyond the rating current of the inductor.

When 4-7LEDs are driven with $V_{IN}=3.6V$, the recommended inductance value is 10 μ H -22 μ H.

- **Selection of Capacitors**

Set 1 μ F or more value bypass capacitor C1 between V_{IN} pin and GND pin as close as possible.

Set 0.22 μ F or more capacitor C2 between V_{OUT} pin and GND pin.

OPERATION OF STEP-UP DC/DC CONVERTER AND OUTPUT CURRENT

<Basic Circuit>

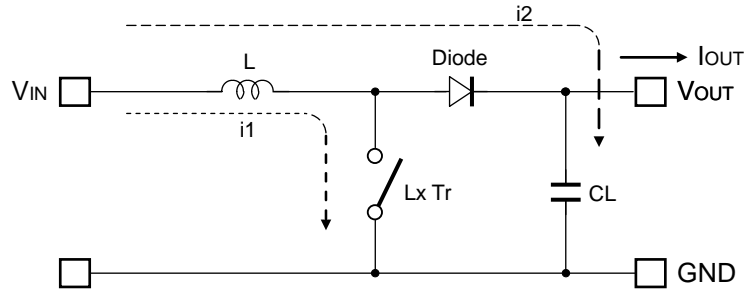

<Current through L>

Discontinuous mode

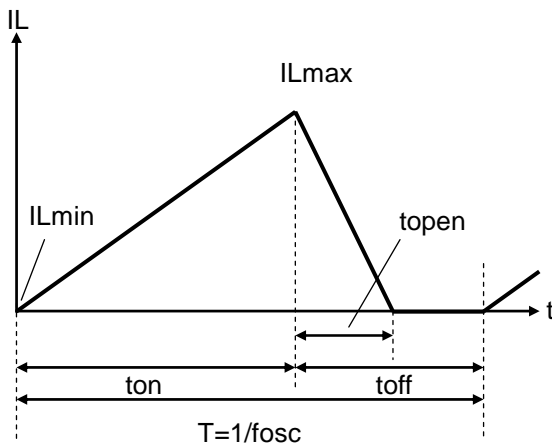

Continuous mode

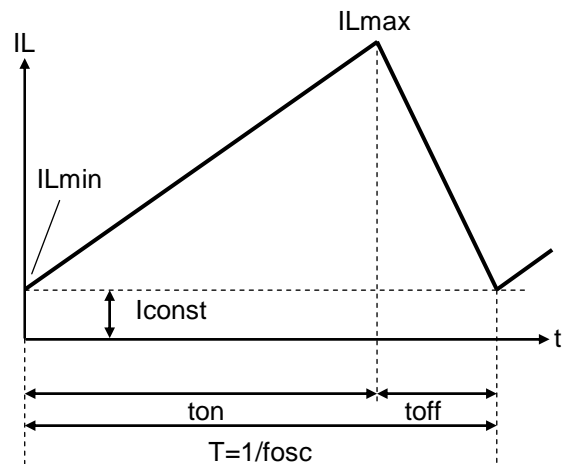

There are two operation modes of the step-up PWM control-DC/DC converter. That is the continuous mode and discontinuous mode by the continuousness inductor.

When the transistor turns ON, the voltage of inductor L becomes equal to V_{IN} voltage. The increase value of inductor current (i_1) will be

$$\Delta i_1 = V_{IN} \times t_{on} / L \dots\dots\dots \text{Formula 1}$$

As the step-up circuit, during the OFF time (when the transistor turns OFF) the voltage is continually supply from the power supply. The decrease value of inductor current (i_2) will be

$$\Delta i_2 = (V_{OUT} - V_{IN}) \times t_{open} / L \dots\dots\dots \text{Formula 2}$$

At the PWM control-method, the inductor current become continuously when $t_{open}=t_{off}$, the DC/DC converter operate as the continuous mode.

In the continuous mode, the variation of current of i_1 and i_2 is same at regular condition.

$$V_{IN} \times t_{on} / L = (V_{OUT} - V_{IN}) \times t_{off} / L \dots\dots\dots \text{Formula 3}$$

The duty at continuous mode will be

$$\text{Duty} = t_{on} / (t_{on} + t_{off}) = (V_{OUT} - V_{IN}) / V_{OUT} \dots\dots\dots \text{Formula 4}$$

The average of inductor current at $t_{open}=t_{off}$ will be

$$I_{L(\text{Ave.})} = V_{IN} \times t_{on} / (2 \times L) \dots\dots\dots \text{Formula 5}$$

If the input power is equal to the output power, the I_{OUT} will be

$$I_{OUT} = V_{IN}^2 \times t_{on} / (2 \times L \times V_{OUT}) \dots\dots\dots \text{Formula 6}$$

If the I_{OUT} value is large than above the calculated value (Formula 6), it will become the continuous mode, At this status, the peak current ($I_{L\text{max}}$) of inductor will be

$$I_{L\text{max}} = I_{OUT} \times V_{OUT} / V_{IN} + V_{IN} \times t_{on} / (2 \times L) \dots\dots\dots \text{Formula 7}$$

$$I_{L\text{max}} = I_{OUT} \times V_{OUT} / V_{IN} + V_{IN} \times T \times (V_{OUT} - V_{IN}) / (2 \times L \times V_{OUT}) \dots\dots\dots \text{Formula 8}$$

The peak current value is larger than the I_{OUT} value. In case of this, selecting the condition of the input and the output and the external components by considering of $I_{L\text{max}}$ value.

The explanation above is based on the ideal calculation, and the loss caused by L_x switch and the external components are not included.

The actual maximum output current will be between 50% and 80% by the above calculations. Especially, when the I_L is large or V_{IN} is low, the loss of V_{IN} is generated with on resistance of the switch. Moreover, it is necessary to consider V_F of the diode (approximately 0.8V) about V_{OUT} .

TYPICAL CHARACTERISTICS

1) Efficiency vs. Output Current Characteristics

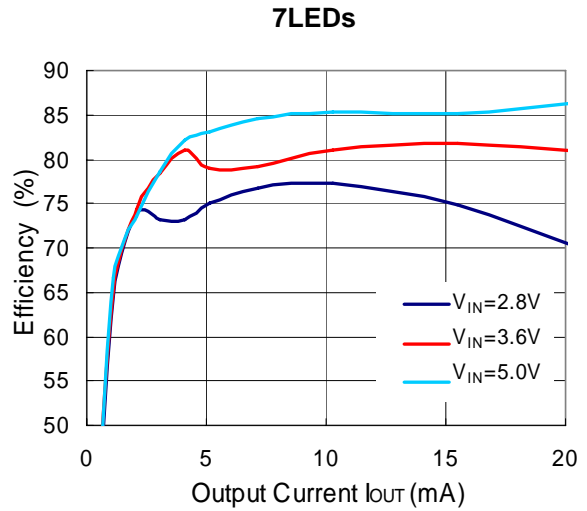
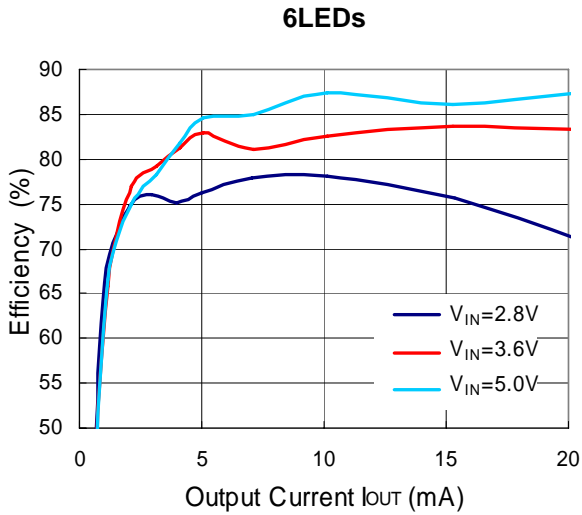

2) PWM Dimming Duty Cycle vs. Output Current($R1=10\Omega$)

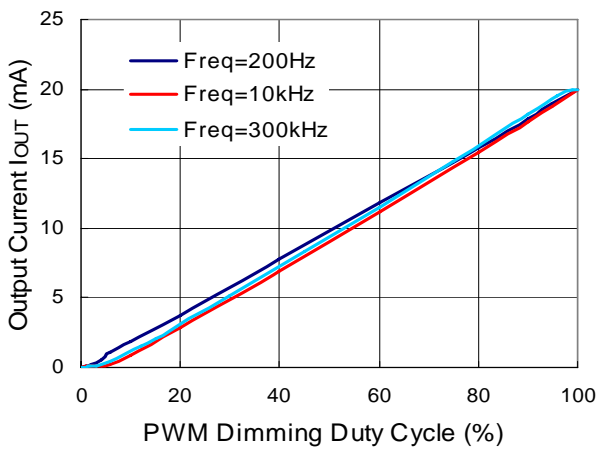

3) Output Current Ripple during PWM Dimming

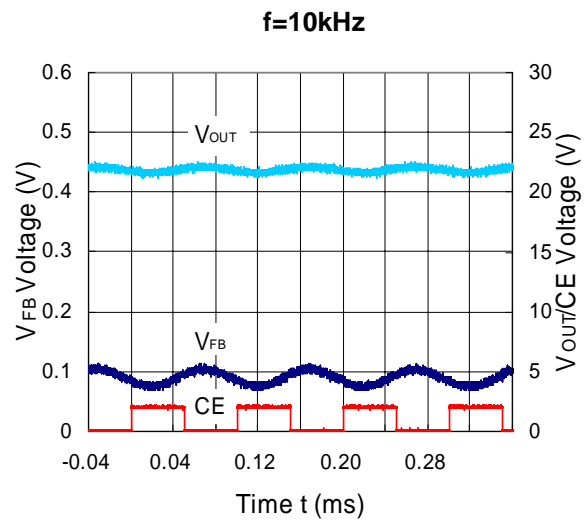
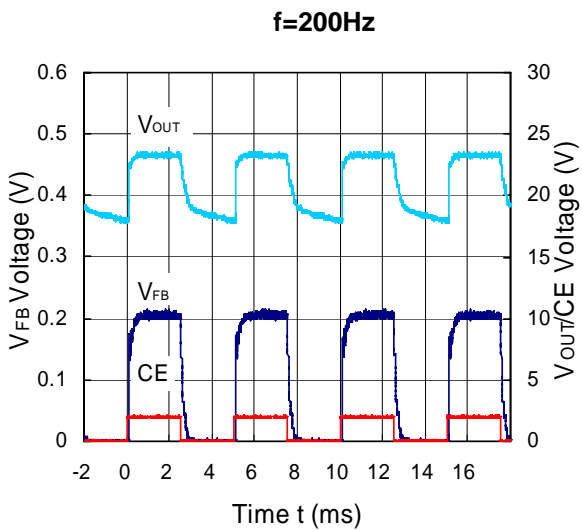

f=300kHz

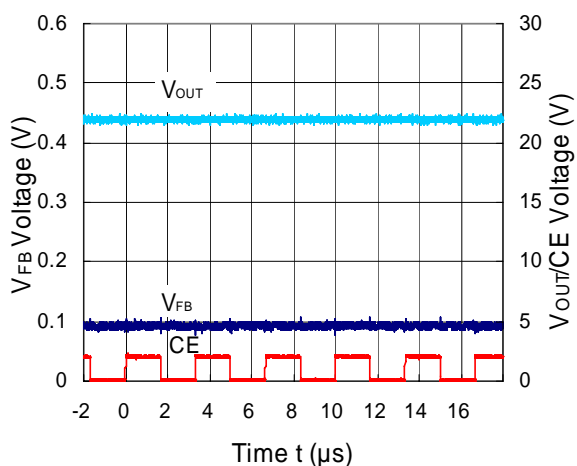

4) VFB Voltage vs. Temperature

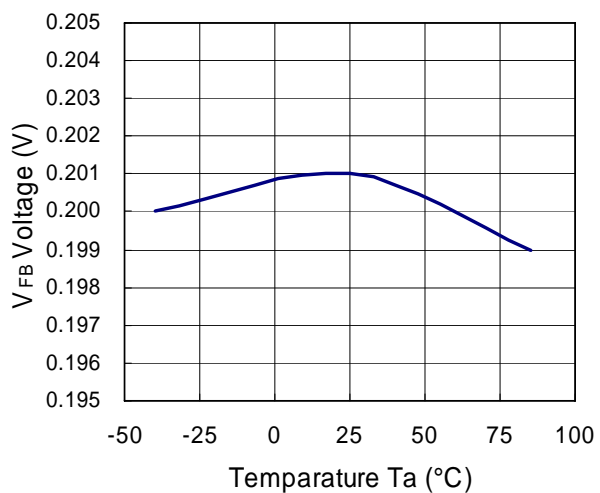

5) Supply Current vs. Temperature

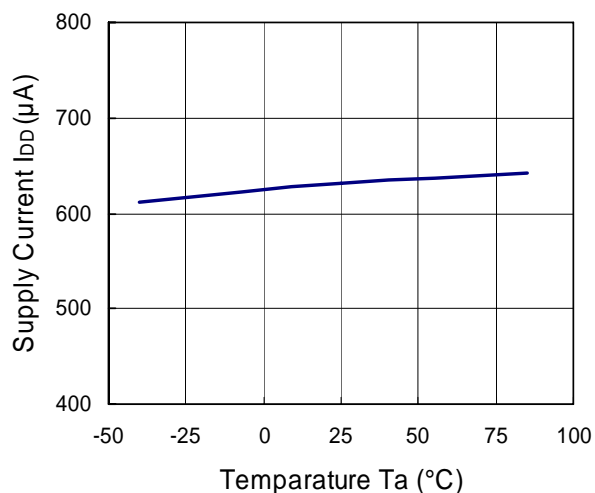

6) Oscillator Frequency vs. Temperature

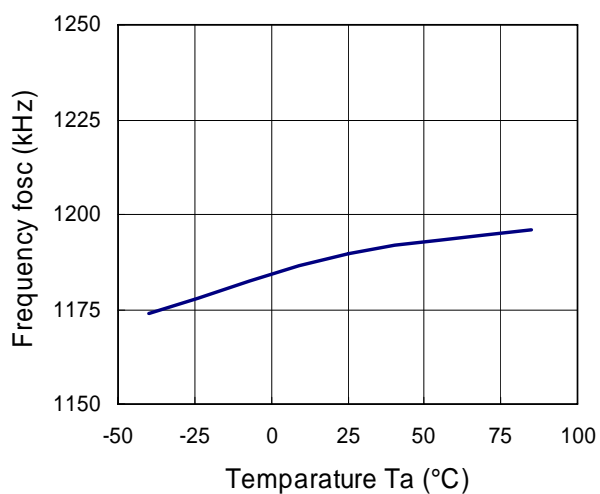

7) Maxduty vs. Temperature

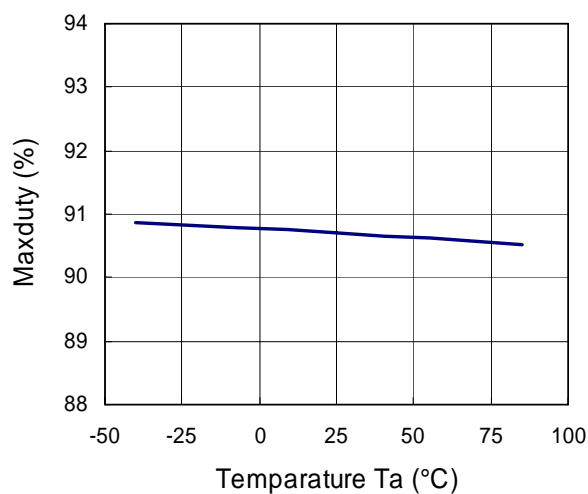

8) UVLO Output Voltage vs. Temperature

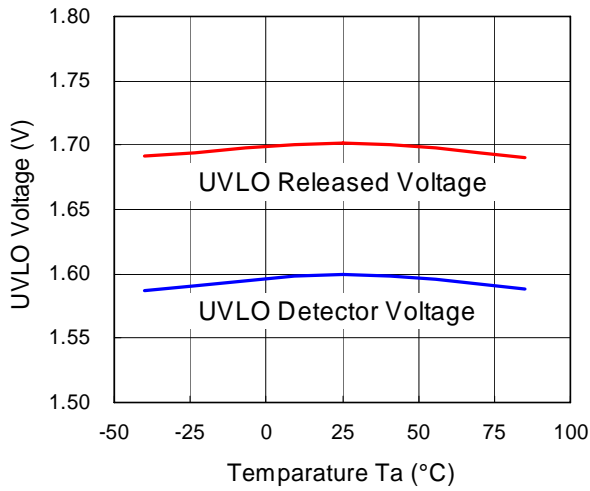

9) OVP Voltage vs. Temperature

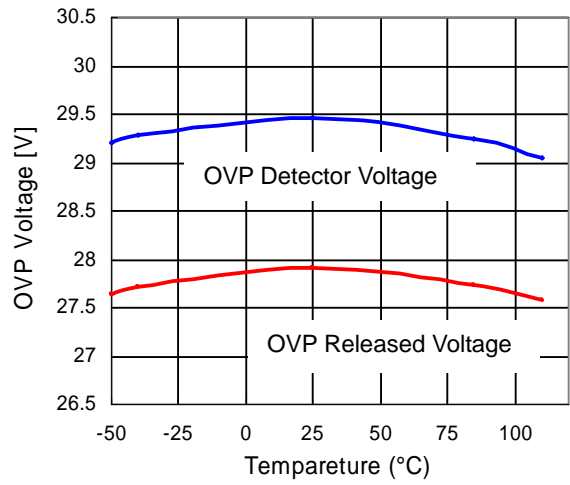

10) Switch ON Resistance vs. Temperature

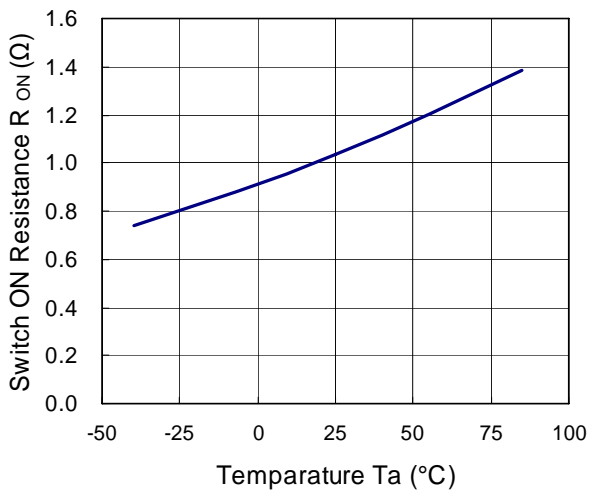

11) Lx Current Limit vs. Temperature

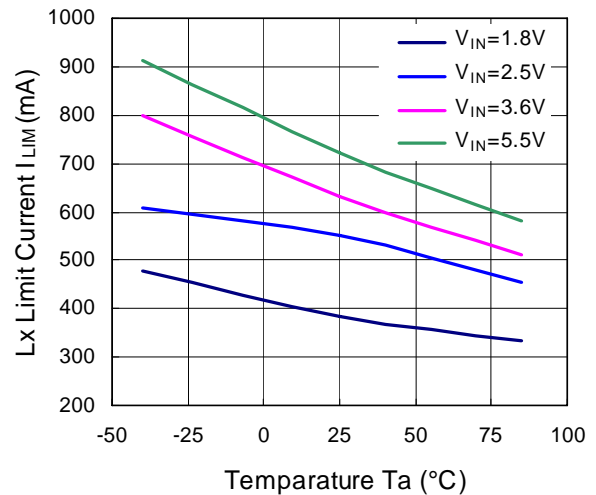

12) OVP Operating Output Voltage Waveform

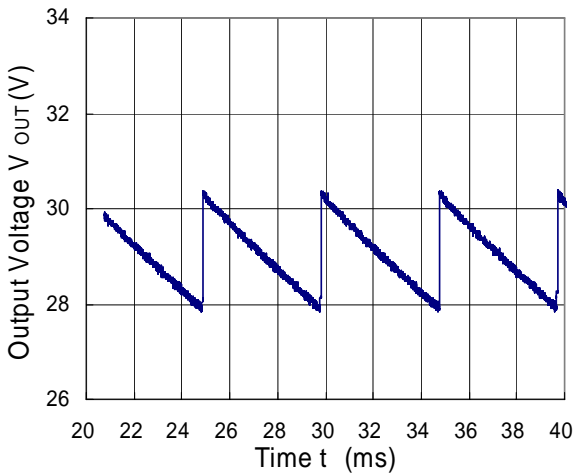



1. The products and the product specifications described in this document are subject to change or discontinuation of production without notice for reasons such as improvement. Therefore, before deciding to use the products, please refer to Ricoh sales representatives for the latest information thereon.
2. The materials in this document may not be copied or otherwise reproduced in whole or in part without prior written consent of Ricoh.
3. Please be sure to take any necessary formalities under relevant laws or regulations before exporting or otherwise taking out of your country the products or the technical information described herein.
4. The technical information described in this document shows typical characteristics of and example application circuits for the products. The release of such information is not to be construed as a warranty of or a grant of license under Ricoh's or any third party's intellectual property rights or any other rights.
5. The products listed in this document are intended and designed for use as general electronic components in standard applications (office equipment, telecommunication equipment, measuring instruments, consumer electronic products, amusement equipment etc.). Those customers intending to use a product in an application requiring extreme quality and reliability, for example, in a highly specific application where the failure or misoperation of the product could result in human injury or death (aircraft, spacevehicle, nuclear reactor control system, traffic control system, automotive and transportation equipment, combustion equipment, safety devices, life support system etc.) should first contact us.
6. We are making our continuous effort to improve the quality and reliability of our products, but semiconductor products are likely to fail with certain probability. In order to prevent any injury to persons or damages to property resulting from such failure, customers should be careful enough to incorporate safety measures in their design, such as redundancy feature, fire containment feature and fail-safe feature. We do not assume any liability or responsibility for any loss or damage arising from misuse or inappropriate use of the products.
7. Anti-radiation design is not implemented in the products described in this document.
8. The X-ray exposure can influence functions and characteristics of the products. Confirm the product functions and characteristics in the evaluation stage.
9. WLCSP products should be used in light shielded environments. The light exposure can influence functions and characteristics of the products under operation or storage.
10. There can be variation in the marking when different AOI (Automated Optical Inspection) equipment is used. In the case of recognizing the marking characteristic with AOI, please contact Ricoh sales or our distributor before attempting to use AOI.
11. Please contact Ricoh sales representatives should you have any questions or comments concerning the products or the technical information.



Ricoh is committed to reducing the environmental loading materials in electrical devices with a view to contributing to the protection of human health and the environment.

Ricoh has been providing RoHS compliant products since April 1, 2006 and Halogen-free products since April 1, 2012.

RICOH RICOH ELECTRONIC DEVICES CO., LTD.

<http://www.e-devices.ricoh.co.jp/en/>

Sales & Support Offices

RICOH ELECTRONIC DEVICES CO., LTD.

Higashi-Shinagawa Office (International Sales)
3-32-3, Higashi-Shinagawa, Shinagawa-ku, Tokyo 140-8655, Japan
Phone: +81-3-5479-2857 Fax: +81-3-5479-0502

RICOH EUROPE (NETHERLANDS) B.V.

Semiconductor Support Centre
Prof. W.H. Keesomlaan 1, 1183 DJ Amstelveen, The Netherlands
Phone: +31-20-5474-309

RICOH INTERNATIONAL B.V. - German Branch

Semiconductor Sales and Support Centre
Oberrather Strasse 6, 40472 Düsseldorf, Germany
Phone: +49-211-6546-0

RICOH ELECTRONIC DEVICES KOREA CO., LTD.

3F, Haesung Bldg, 504, Teheran-ro, Gangnam-gu, Seoul, 135-725, Korea
Phone: +82-2-2135-5700 Fax: +82-2-2051-5713

RICOH ELECTRONIC DEVICES SHANGHAI CO., LTD.

Room 403, No.2 Building, No.690 Bibo Road, Pu Dong New District, Shanghai 201203, People's Republic of China
Phone: +86-21-5027-3200 Fax: +86-21-5027-3299

RICOH ELECTRONIC DEVICES CO., LTD.

Taipei office
Room 109, 10F-1, No.51, Hengyang Rd., Taipei City, Taiwan (R.O.C.)
Phone: +886-2-2313-1621/1622 Fax: +886-2-2313-1623